



County of Fresno

DEPARTMENT OF PUBLIC WORKS AND PLANNING
BERNARD JIMENEZ, INTERIM DIRECTOR

ADDENDUM

Planning Commission Staff Report Agenda Item No. 4 March 24, 2016

SUBJECT: Initial Study Application No. 6888 and Classified Conditional Use Permit Application No. 3478

Allow an approximately 3,939 square-foot religious facility with related improvements on a 2.50-acre parcel in the R-R(nb) (Rural Residential, two-acre minimum parcel size, Neighborhood Beautification Overlay) Zone District.

Note: This Item was continued from the November 19, 2015 Planning Commission Hearing.

LOCATION: The subject parcel is located on the northeast corner of McKinley Avenue and Blythe Avenue, approximately 40 feet east of the nearest city limits of the City of Fresno (4354 W. McKinley Avenue) (Sup. Dist. 1) (APN 312-082-14).

OWNER/APPLICANT: Sy Nguyen Le

STAFF CONTACT: Derek Chambers, Planner
(559) 600-4205

Chris Motta, Principal Planner
(559) 600-4227

RECOMMENDATION:

- Adopt the Revised Mitigated Negative Declaration prepared for Initial Study (IS) Application No. 6888; and
- Approve Classified Conditional Use Permit (CUP) Application No. 3478 with recommended Findings and Conditions; and
- Direct the Secretary to prepare a Resolution documenting the Commission's action.

EXHIBITS:

1. Staff Report and Exhibits dated November 19, 2015
2. Revised Mitigation Monitoring, Conditions of Approval and Project Notes
3. Revised Summary of Initial Study Application No. 6888

PUBLIC NOTICE:

Notices were sent to 26 property owners within 600 feet of the subject parcel, exceeding the minimum notification requirements prescribed by the California Government Code and County Zoning Ordinance.

BACKGROUND INFORMATION:

At the Planning Commission’s regularly-scheduled November 19, 2015 Hearing, the Commission expressed concern that Irrevocable Offers of Right-of-Way Dedication for McKinley Avenue and Blythe Avenue were included as Mitigation Measures for the project. Further, the Commission approved a motion continuing the Hearing to a date uncertain to allow Staff an opportunity to re-evaluate the Initial Study (IS) environmental analysis as it pertains to transportation and traffic. As such, Staff re-engaged concerned agencies regarding the Right-of-Way issue identified by the Commission, and revised the IS environmental analysis in light of the project scope and the amount of traffic to be generated by the proposed use. The Revised IS environmental analysis was re-circulated for agency review on February 24, 2016.

This proposal entails the utilization of an existing 2,613 square-foot single-family residence with 1,326 square-foot porch area located on a 2.50-acre parcel in the R-R(nb) (Rural Residential, two-acre minimum parcel size, Neighborhood Beautification Overlay) Zone District as a religious facility. No exterior modification or expansion of the existing single-family residence structure is proposed with this project. The proposed religious facility will host services for approximately 12 followers on Saturday and Sunday mornings, year-round. These services will be conducted within the interior of the existing single-family residence, and no outdoor sound amplification is proposed with this project. Additionally, approximately 40 people will visit the site during the following annual special events:

- Buddha’s Birthday, one Sunday in May from 9am – 2pm
- Annual Parents’ Gratitude Day, one Sunday usually in August from 9am – 2pm
- Chinese/Vietnamese Lunar New Year, one day usually in February from early morning to late afternoon

ANALYSIS:

The subject parcel currently has access from McKinley Avenue via two existing 13-foot-wide paved driveways. The proposed religious facility will utilize these existing driveways in conjunction with a proposed paved parking lot with 32 parking spaces and a proposed 18-foot-wide paved driveway on Blythe Avenue that will be utilized for exit only.

The proposed religious facility will host services for approximately 12 followers on Saturday and Sunday mornings, year-round, and approximately 40 people will visit the site during three annual special events, which include Buddha’s Birthday (one Sunday in May from 9am – 2pm), Annual Parents’ Gratitude Day (one Sunday usually in August from 9am – 2pm), and

Chinese/Vietnamese Lunar New Year (one day usually in February from early morning to late afternoon). As such, the proposed use may generate approximately 24 one-way visitor trips (12 round trips) for religious services on Saturdays and Sundays, year-round, and approximately 80 one-way visitor trips (40 round trips) per each of the three annual special events.

With regard to right-of-way, the Road Maintenance and Operations Division of the Fresno County Department of Public Works and Planning commented that an irrevocable offer of 13 feet of additional right-of-way dedication is needed from the southern side of the subject parcel which abuts McKinley Avenue in order to comply with the Arterial right-of-way standard identified in the Transportation and Circulation Element of the County General Plan. Additionally, the Road Maintenance and Operations Division also commented that irrevocable offers of 33 feet and 23 feet of additional right-of-way dedication are needed from the western side of the subject parcel which abuts Blythe Avenue in order to comply with the Arterial right-of-way standard identified in the Transportation and Circulation Element of the County General Plan.

This proposal was also reviewed by the Design Division of the Fresno County Department of Public Works and Planning, which expressed no traffic-related concerns regarding the project, nor did said agency require preparation of a Traffic Impact Study (TIS). However, said agency did comment that the irrevocable offers of additional right-of-way dedication for McKinley Avenue and Blythe Avenue as identified by the Road Maintenance and Operations Division are necessary to ensure compliance with the Transportation and Circulation Element of the County General Plan.

The City of Fresno Public Works Department also reviewed this proposal with regard to right-of-way. According to said agency, the intersection of McKinley Avenue and Blythe Avenue is planned to someday have full improvements, including traffic signals. As such, the irrevocable offers of additional right-of-way dedication for McKinley Avenue and Blythe Avenue as identified by the Road Maintenance and Operations Division are necessary to ensure orderly development of the intersection. Further, the City depends on development projects as a means to acquire right-of-way needed for road improvement projects.

Staff acknowledges that the irrevocable offers of additional right-of-way dedication for McKinley Avenue and Blythe Avenue as identified by the Road Maintenance and Operations Division would help to bring the roadways into further compliance with the Arterial right-of-way standard identified in the Transportation and Circulation Element of the County General Plan. Staff also acknowledges that the City could experience some economic hardship in the future if the intersection is improved, should the irrevocable offers of additional right-of-way dedication for McKinley Avenue and Blythe Avenue not be required. However, no substantial traffic hazard issues were identified by any agency reviewing this proposal. Further, the amount of traffic to be generated by the proposed use (approximately 24 one-way visitor trips for religious services on Saturdays and Sundays, and approximately 80 one-way visitor trips for three annual special events) has been determined to be less than significant and will not impact roadways in the area. As such, no irrevocable offers of additional right-of-way dedication are required for this project.

FINDINGS:

No additional information has been received to alter staff's original ability to make the four required Findings for granting the Classified Conditional Use Permit. As such, staff recommends approval of Classified Conditional Use Permit Application No. 3478. Please see Exhibit 1 of this Addendum Staff Report for complete Conditional Use Permit Findings.

CONCLUSION:

No substantial traffic hazard issues were identified by any agency reviewing this proposal. Further, the amount of traffic to be generated by the proposed use has been determined to be less than significant and will not impact roadways in the area. As such, no irrevocable offers of additional right-of-way dedication are required for this project.

PLANNING COMMISSION MOTIONS:

Recommended Motion (Approval Action)

- Move to adopt the Mitigated Negative Declaration as revised for Initial Study Application No. 6888; and
- Move to determine the required Findings can be made and move to approve Classified Conditional Use Permit Application No. 3478, subject to the Mitigation Measures, Conditions of Approval and Project Notes listed in Exhibit 1; and
- Direct the Secretary to prepare a Resolution documenting the Commission's action.

Alternative Motion (Denial Action)

- Move to determine that the required Findings cannot be made (state basis for not making the Findings) and move to deny Classified Conditional Use Permit Application No. 3478; and
- Direct the Secretary to prepare a Resolution documenting the Commission's action.

Mitigation Measures, Recommended Conditions of Approval and Project Notes:

See attached Exhibit 1.

DC:ksn
G:\4360Devs&PIn\PROJSEC\PROJDOCS\CUP\3400-3499\3478\SR\NEW SR\CUP3478 SR Addendum.docx



EXHIBIT 1

County of Fresno

DEPARTMENT OF PUBLIC WORKS AND PLANNING
ALAN WEAVER, DIRECTOR

Planning Commission Staff Report Agenda Item No. 4 November 19, 2015

SUBJECT: Initial Study Application No. 6888 and Classified Conditional Use Permit Application No. 3478

Allow an approximately 3,939 square-foot religious facility with related improvements on a 2.50-acre parcel in the R-R(nb) (Rural Residential, two-acre minimum parcel size, Neighborhood Beautification Overlay) Zone District.

LOCATION: The subject parcel is located on the northeast corner of McKinley Avenue and Blythe Avenue, approximately 40 feet east of the nearest city limits of the City of Fresno (4354 W. McKinley Avenue) (Sup. Dist. 1) (APN 312-082-14).

OWNER/APPLICANT: Sy Nguyen Le

STAFF CONTACT: Derek Chambers, Planner
(559) 600-4205

Eric VonBerg, Senior Planner
(559) 600-4569

RECOMMENDATION:

- Adopt the Mitigated Negative Declaration prepared for Initial Study (IS) Application No. 6888; and
- Approve Classified Conditional Use Permit (CUP) Application No. 3478 with recommended Findings and Conditions; and
- Direct the Secretary to prepare a Resolution documenting the Commission's action.

EXHIBITS:

1. Mitigation Monitoring, Conditions of Approval and Project Notes
2. Location Map
3. Existing Zoning Map
4. Existing Land Use Map
5. Site Plan
6. Floor Plan
7. Elevations
8. Applicant's Operational Statement
9. Summary of Initial Study Application No. 6888

SITE DEVELOPMENT AND OPERATIONAL INFORMATION:

Criteria	Existing	Proposed
General Plan Designation	Rural Residential in the County-adopted Fresno High-Roeding Community Plan	No change
Zoning	R-R(nb) (Rural Residential, two-acre minimum parcel size, Neighborhood Beautification Overlay)	No change
Parcel Size	2.50 acres	No change
Project Site	2,613 square-foot single-family residence with 1,326 square-foot porch area; septic system; water well; two 13-foot-wide paved driveways accessing McKinley Avenue	Utilization of an existing 2,613 square-foot single-family residence with 1,326 square-foot porch area as a religious facility; two 13-foot-wide paved driveways accessing McKinley Avenue; one 18-foot-wide paved driveway accessing Blythe Avenue to be utilized for exit only; paved parking lot with 32 parking spaces
Structural Improvements	2,613 square-foot single-family residence with 1,326 square-foot porch area	2,613 square-foot single-family residence with 1,326 square-foot porch area to be utilized as a religious facility

Criteria	Existing	Proposed
Nearest Residence	Approximately 10 feet north of the subject parcel	No change
Surrounding Development	Residential subdivisions; elementary school (Central Unified McKinley Elementary School) westerly adjacent; high school (Central Unified High School East Campus) approximately one and a half miles to the northwest; State Route (SR) 99 approximately two miles to the east	No change
Operational Features	N/A	<p>Religious facility utilized by Applicant to host services for approximately 12 followers on Saturday and Sunday mornings, year round. These services will be conducted within the interior of the existing single-family residence, and no outdoor sound amplification is proposed with this project.</p> <p>Approximately 40 guests will visit the site during the following annual special events: Buddha's Birthday (one Sunday in May from 9am – 2pm); Annual Parents Gratitude Day (one Sunday usually in August from 9am – 2pm); Chinese/Vietnamese Lunar New Year (one day usually in February from early morning to late afternoon)</p>
Employees	N/A	None
Customers	N/A	<p>Approximately 12 followers are anticipated to visit the religious facility on Saturday and Sunday mornings, year round.</p> <p>Approximately 40 guests are anticipated to visit the</p>

Criteria	Existing	Proposed
		religious facility during the following annual special events: Buddha's Birthday (one Sunday in May from 9am – 2pm); Annual Parents Gratitude Day (one Sunday usually in August from 9am – 2pm); Chinese/Vietnamese Lunar New Year (one day usually in February from early morning to late afternoon)
Traffic Trips	Residential traffic	Approximately 24 one-way visitor trips (12 round trips) for religious services on Saturdays and Sundays, year round Approximately 80 one-way visitor trips (40 round trips) per each of the three annual special events
Lighting	Residential lighting	No additional lighting proposed
Hours of Operation	N/A	<u>Religious Services:</u> Saturday and Sunday mornings, year-round <u>Annual Special Events:</u> Buddha's Birthday (one Sunday in May) from 9am – 2pm; Annual Parents Gratitude Day (one Sunday usually in August) from 9am – 2pm; Chinese/Vietnamese Lunar New Year (one day usually in February) from early morning to late afternoon .

EXISTING VIOLATION (Y/N) AND NATURE OF VIOLATION: None

ENVIRONMENTAL ANALYSIS:

An Initial Study (IS) was prepared for the project by County staff in conformance with the provisions of the California Environmental Quality Act (CEQA). Based on the IS, staff has

determined that a Mitigated Negative Declaration is appropriate. A summary of the Initial Study is below and included as Exhibit 9.

Notice of Intent to Adopt a Mitigated Negative Declaration publication date: October 30, 2015

PUBLIC NOTICE:

Notices were sent to 26 property owners within 600 feet of the subject parcel, exceeding the minimum notification requirements prescribed by the California Government Code and County Zoning Ordinance.

PROCEDURAL CONSIDERATIONS:

A Classified Conditional Use Permit (CUP) Application may be approved only if four Findings specified in the Fresno County Zoning Ordinance, Section 873-F are made by the Planning Commission.

The decision of the Planning Commission on a Classified CUP Application is final, unless appealed to the Board of Supervisors within 15 days of the Commission's action.

BACKGROUND INFORMATION:

This proposal entails the utilization of an existing 2,613 square-foot single-family residence with 1,326 square-foot porch area located on a 2.50-acre parcel in the R-R(nb) (Rural Residential, two-acre minimum parcel size, Neighborhood Beautification Overlay) Zone District as a religious facility. No exterior modification or expansion of the existing single-family residence structure is proposed with this project. The proposed religious facility will host services for approximately 12 followers on Saturday and Sunday mornings, year round. These services will be conducted within the interior of the existing single-family residence, and no outdoor sound amplification is proposed with this project. Additionally, approximately 40 people will visit the site during the following annual special events:

- Buddha's Birthday, one Sunday in May from 9am – 2pm
- Annual Parents Gratitude Day, one Sunday usually in August from 9am – 2pm
- Chinese/Vietnamese Lunar New Year, one day usually in February from early morning to late afternoon

The subject parcel currently has access from McKinley Avenue via two existing 13-foot-wide paved driveways. The proposed religious facility will utilize these existing driveways in conjunction with a proposed paved parking lot with 32 paved parking spaces and a proposed 18-foot-wide paved driveway on Blythe Avenue that will be utilized for exit only.

Finding 1: That the site of the proposed use is adequate in size and shape to accommodate said use and all yards, spaces, walls and fences, parking, loading, landscaping, and other features required by this Division, to adjust said use with land and uses in the neighborhood.

	Current Standard:	Proposed Operation:	Is Standard Met (y/n)
Setbacks	Front: 35 feet Side: 20 feet Street Side: 25 feet	Front (south property line): 53 feet Side (east property	Yes

	Current Standard:	Proposed Operation:	Is Standard Met (y/n)
	Rear: 20 feet	line): 60 feet Street Side (west property line): 160 feet Rear (north property line): 205 feet	
Parking	One parking space for every 40 square feet of area within the main auditorium or meeting hall; one parking space for the physically handicapped for every 25 parking spaces required	32 standard paved parking spaces; two parking spaces for the physically handicapped	Yes
Lot Coverage	No requirement	N/A	N/A
Space Between Buildings	Six feet minimum (75 feet minimum between human habitations and structures utilized to house animals)	N/A	N/A
Wall Requirements	No requirement	N/A	N/A
Septic Replacement Area	100 percent	N/A (proposed religious facility shall be required to use community sewer service provided by the City of Fresno)	N/A
Water Well Separation	Septic tank: 50 feet; Disposal field: 100 feet; Seepage pit: 150 feet	N/A (proposed religious facility shall be required to use community water service provided by the City of Fresno)	N/A

Reviewing Agency/Department Comments Regarding Site Adequacy:

Zoning Section of the Fresno County Department of Public Works and Planning: Existing and proposed improvements satisfy the setback requirements of the R-R(nb) (Rural Residential, two-acre minimum parcel size, Neighborhood Beautification Overlay) Zone District. Completion of a Site Plan Review is recommended to ensure compliance with development standards.

No other comments specific to the adequacy of the site were expressed by reviewing Agencies or Departments.

Analysis:

Staff review of the Site Plan demonstrates that the existing single-family residence to be

converted into the proposed religious facility satisfies the minimum building setback requirements of the R-R(nb) (Rural Residential, two-acre minimum parcel size, Neighborhood Beautification Overlay) Zone District. The existing single-family residence is set back approximately 53 feet from the ultimate right-of-way for McKinley Avenue (35 feet required), approximately 160 feet from the ultimate right-of-way for Blythe Avenue (25 feet required), approximately 60 feet from the eastern property line of the subject parcel (20 feet required), and approximately 205 feet from the northern property line of the subject parcel (20 feet required).

With regard to off-street parking for religious facilities, the Zoning Ordinance requires at least one parking space to be provided for every 40 square feet of area within the main auditorium or meeting hall. Further, California Building Code requires the provision of at least one parking space for the physically handicapped per every 25 parking spaces required at a facility. The existing single-family residence to be converted into the proposed religious facility will have a 704 square-foot sanctuary. As such, the proposed religious facility needs to have at least 18 parking spaces, one of which needs to be provided for the physically handicapped. The Applicant proposes to provide 32 standard parking spaces and two spaces for the physically handicapped.

Based on the above information and with adherence to a Site Plan Review (SPR) required as a Condition of Approval, staff finds that the subject parcel is adequate in size and shape to accommodate the proposed use. Conditions of the SPR may include: design of parking and circulation areas, access, on-site grading and drainage, fire protection, landscaping, signage and lighting.

Recommended Conditions of Approval:

See Recommended Conditions of Approval attached as Exhibit 1.

Conclusion:

Finding 1 can be made.

Finding 2: That the site for the proposed use relates to streets and highways adequate in width and pavement type to carry the quantity and kind of traffic generated by the proposed use.

		Existing Conditions	Proposed Operation
Private Road	No	N/A	No change
Public Road Frontage	Yes	McKinley Avenue: Very poor condition Blythe Avenue: Poor condition	No change
Direct Access to Public Road	Yes	McKinley Avenue: Two 13-foot-wide paved driveways	McKinley Avenue: No change Blythe Avenue: one 18-foot-wide paved driveway to be utilized for exit only

		Existing Conditions	Proposed Operation
Road ADT		McKinley Avenue: 5,900 Blythe Avenue: 1,500	Less than significant traffic increase
Road Classification		McKinley Avenue: Arterial Blythe Avenue: Arterial	No change
Road Width		McKinley Avenue: 80-foot total existing right-of-way Blythe Avenue: Variable total existing right-of-way ranging from 40 to 60 feet	McKinley Avenue: Irrevocable offer of 13 feet of additional right-of-way dedication shall be required from the southern side of the subject parcel which abuts McKinley Avenue. Blythe Avenue: Irrevocable offers of 33 feet and 23 feet of additional right-of-way dedication shall be required from the western side of the subject parcel which abuts Blythe Avenue.
Road Surface		McKinley Avenue: Paved (pavement width: 32.7 feet) Blythe Avenue: Paved (pavement width: 22.8 feet)	No change
Traffic Trips		Residential traffic	Approximately 24 one-way visitor trips (12 round trips) for religious services on Saturdays and Sundays, year round Approximately 80 one-way visitor trips (40 round trips) per each of the three annual special events
Traffic Impact Study (TIS) Prepared	No	N/A	Not required by the Design Division of the Fresno County Department of Public Works and Planning

	Existing Conditions	Proposed Operation
Road Improvements Required	N/A	None required

Reviewing Agency/Department Comments Regarding Adequacy of Streets and Highways:

City of Fresno Public Works Department: The Applicant shall be required to provide the following within the limits of the project site: 1) concrete curb, gutter, and sidewalk along the McKinley Avenue frontage and Blythe Avenue frontage of the subject parcel, constructed in compliance with City of Fresno Public Works Department Standard P-5 development criteria; 2) underground street lighting system constructed in compliance with City of Fresno Public Works Department Standard E-1, spacing and design shall conform to City of Fresno Public Works Department Standard E-7 for arterial roads; and 3) underground all existing overhead utilities.

Design Division of the Fresno County Department of Public Works and Planning: No concerns with the proposal.

Development Engineering Section of the Fresno County Department of Public Works and Planning: 20-foot by 20-foot corner cutoffs shall be maintained for sight distance purposes at any driveway accessing McKinley Avenue or Blythe Avenue. This requirement has been included as a Project Note.

Road Maintenance and Operations Division of the Fresno County Department of Public Works and Planning: McKinley Avenue is a County-maintained road which is classified as an Arterial. The minimum total width for an Arterial right-of-way is 106 feet. McKinley Avenue has a total existing right-of-way of 80 feet at the subject parcel, with 40 feet north and 40 feet south of the section line. Blythe Avenue is jointly maintained by the County and City of Fresno, and is classified as an Arterial. The minimum total width for an Arterial right-of-way is 106 feet. The portion of Blythe Avenue that fronts the subject parcel has a variable total existing right-of-way which ranges from 40 feet, with 20 feet east and 20 feet west of the center line, to 60 feet, with 30 feet east and 30 feet west of the center line. An Encroachment Permit shall be required from the Road Maintenance and Operations Division for any work performed within the County right-of-way. This requirement has been included as a Project Note. All parking and circulation areas shall be surfaced with asphalt concrete (AC) paving. This requirement has been included as a Mitigation Measure to reduce potential impacts to transportation to less than significant.

No other comments specific to the adequacy of streets and highways were expressed by reviewing Agencies or Departments.

Analysis:

The subject parcel currently has access from McKinley Avenue via two existing 13-foot-wide paved driveways. The proposed religious facility will utilize these existing driveways in conjunction with a proposed paved parking lot with 32 paved parking spaces and a proposed 18-foot-wide paved driveway on Blythe Avenue that will be utilized for exit only.

According to the Road Maintenance and Operations Division of the Fresno County Department of Public Works and Planning, McKinley Avenue is a County-maintained road with an existing 40-foot right-of-way north of the section line which fronts the subject parcel. Due to McKinley Avenue being classified as an Arterial, McKinley Avenue has an ultimate right-of-way of 106 feet

at the subject parcel, with 53 feet north and 53 feet south of the section line. As such, an irrevocable offer of 13 feet of additional right-of-way dedication is needed from the southern side of the subject parcel which abuts McKinley Avenue. Additionally, Blythe Avenue is jointly maintained by the County and City of Fresno, and the portion of Blythe Avenue that fronts the subject parcel has a variable existing right-of-way which ranges from 20 to 30 feet east of the center line. Due to Blythe Avenue being classified as an Arterial, Blythe Avenue has an ultimate right-of-way of 106 feet at the subject parcel, with 53 feet east and 53 feet west of the center line. As such, irrevocable offers of 33 feet and 23 feet of additional right-of-way dedication are needed from the western side of the subject parcel which abuts Blythe Avenue. These requirements for additional right-of-way dedication have been included as Mitigation Measures to reduce potential impacts to transportation to less than significant, and shall be reviewed for approval during the Site Plan Review (SPR) process that has also been included as a Condition of Approval. Conditions of the SPR may include: design of parking and circulation areas, access, on-site grading and drainage, fire protection, landscaping, signage and lighting.

With regard to traffic, the proposed religious facility will host services for approximately 12 followers on Saturday and Sunday mornings, year round, and approximately 40 people will visit the site during three annual special events, which include Buddha's Birthday (one Sunday in May from 9am – 2pm), Annual Parents Gratitude Day (one Sunday usually in August from 9am – 2pm), and Chinese/Vietnamese Lunar New Year (one day usually in February from early morning to late afternoon). As such, the proposed use may generate approximately 24 one-way visitor trips (12 round trips) for religious services on Saturdays and Sundays, year round, and approximately 80 one-way visitor trips (40 round trips) per each of the three annual special events. This proposal was reviewed by the Design Division of the Fresno County Department of Public Works and Planning, which expressed no traffic-related concerns regarding the project, nor did said agency require preparation of a Traffic Impact Study (TIS).

The City of Fresno Public Works Department reviewed this proposal and commented that the Applicant should be required to provide a concrete curb, gutter, and sidewalk along the McKinley Avenue frontage and Blythe Avenue frontage of the subject parcel, constructed in compliance with the City of Fresno Public Works Department Standard P-5 development criteria. However, no substantial traffic hazard or substantial emergency access issue was identified by the City of Fresno to require such improvements under CEQA. Further, the portions of McKinley Avenue and Blythe Avenue which are contiguous with the subject parcel do not have any existing curbs, gutters or sidewalks.

The City of Fresno also requested that the Applicant be required to construct a street lighting system and underground all existing overhead utilities within the limits of the project site. Staff does not believe there is a nexus for such a request considering that the portions of McKinley Avenue and Blythe Avenue which are contiguous with the subject parcel do not have an existing street lighting system or underground utilities.

Based on the above information, and with adherence to the Mitigation Measures, recommended Conditions of Approval and mandatory Project Notes described above, staff finds that the surrounding streets serving the project site will remain adequate to accommodate the proposed use.

Recommended Conditions of Approval:

See Recommended Conditions of Approval attached as Exhibit 1.

Conclusion:

Finding 2 can be made.

Finding 3: That the proposed use will have no adverse effect on abutting property and surrounding neighborhood or the permitted use thereof.

Surrounding Parcels				
	Size:	Use:	Zoning:	Nearest Residence:
North	4.08 acres	Single-family residence	R-R(nb)	Approximately 10 feet to the north
South	16,400 square feet	Single-family residence	R-R(nb)	Approximately 107 feet to the south
	18,400 square feet	Single-family residence	R-R(nb)	Approximately 104 feet to the south
	1.81 acres	Single-family residence	R-R(nb)	Approximately 85 feet to the south
	2.39 acres	Single-family residence	R-R(nb)	Approximately 113 feet to the southeast
East	2.08 acres	Two single-family residences	R-R(nb)	Approximately 55 feet to the east
West	4.44 acres	Elementary school (Central Unified McKinley Elementary School)	City of Fresno	None

Reviewing Agency/Department Comments:

Fresno County Department of Agriculture (Agricultural Commissioner's Office): No concerns with the proposal.

Fresno Irrigation District (FID): FID does not own, operate or maintain any facilities located within the limits of the subject parcel.

Building and Safety Section of the Fresno County Department of Public Works and Planning: If approved, plans related to construction and development of the project prepared by a licensed design professional shall be submitted to the Development Services Division of the Fresno County Department of Public Works and Planning for review and approval in order to acquire building and installation permits, and necessary inspections. This requirement has been included as a Project Note.

Fresno County Department of Public Health, Environmental Health Division: County records indicate that the septic system serving the existing single-family residence is located on the south side of said structure, partially within the ultimate right-of-Way of McKinley Avenue. County records also indicate that the septic system serving the existing single-family residence

is not adequate to serve the proposed use. It is highly recommended that the Applicant investigate the potential to connect to community sewer and water services operated by the City of Fresno.

North Central Fire Protection District: No concerns with regard to water supply, fire hydrants, and fire apparatus access. Review for compliance with fire and life safety requirements for the building interior will be conducted by the North Central Fire Protection District when plans are submitted to the Fresno County Department of Public Works and Planning for the change of occupancy from single-family residence to religious facility.

San Joaquin Valley Unified Air Pollution Control District (Air District): No concerns with the proposal.

State Water Resource Control Board, Division of Drinking Water: The proposed use does not require permitting as a public water system. Permitting as a public water system is required in cases where at least 25 individuals are on site for at least 60 days per year.

Central Unified School District: No concerns with the proposal.

City of Fresno Department of Public Utilities: Connection of the proposed religious facility to the community sewer system operated by the City of Fresno is required per Fresno Municipal Code (FMC) Section 6-303. The nearest City of Fresno sewer main in relation to the subject parcel terminates at the intersection of Blythe Avenue and McKinley Avenue. Connection of the proposed religious facility to the community sewer system operated by the City of Fresno has the following requirements that the Applicant must abide by, which are included as Mitigation Measures to reduce potential impacts to soils to less than significant: 1) Construct an 8-inch sanitary sewer main (including sewer house branches to adjacent properties) in N. Blythe Avenue from the existing 15-inch sewer main in W. McKinley Avenue north across the project frontage; 2) Construct a 15-inch sanitary sewer main (including sewer house branches to adjacent properties) in W. McKinley Avenue from the existing 15-inch sewer main at the intersection of W. McKinley and N. Blythe Avenue east across the project frontage; 3) Any existing septic system located on the subject parcel shall be properly destroyed under permit and inspection by the Fresno County Department of Public Works and Planning prior to occupancy being granted for the proposed religious facility; 4) Engineered improvement plans prepared by a Registered Civil Engineer shall be submitted for City of Fresno Department of Public Utilities review and approval for proposed additions to the City sewer system; 5) All public sanitary sewer facilities shall be constructed in accordance with City of Fresno Standards, Specifications, and Policies; and 6) Pay all applicable City of Fresno Sewer Connection Fees per the Fresno Municipal Code and the City of Fresno Master Fee Schedule.

The nearest City of Fresno water main available to serve the proposed use is located within Blythe Avenue, westerly adjacent to the subject parcel. Connection of the proposed religious facility to the community water system operated by the City of Fresno has the following requirements that the Applicant must abide by, which are included as Mitigation Measures to reduce potential impacts to groundwater to less than significant: 1) The existing single-family residence shall be connected to the community water system operated by the City of Fresno prior to occupancy being granted for the proposed religious facility; 2) The Applicant shall provide the City of Fresno Department of Public Utilities with a detailed water usage analysis identifying water fixture, landscape, and laundry efficiencies to document water conservation design characteristics, subject to approval by the Director of the City of Fresno Department of Public Utilities; 3) Installation of water service(s) and meter box(es) shall be required; 4) Pay all applicable City of Fresno Water Connection Fees per the Fresno Municipal Code and the City of

Fresno Master Fee Schedule; and 5) Seal and abandon any existing onsite water well in accordance with City of Fresno Standards and State of California Well Standards Bulletin 74-90, or current revisions issued by the California Department of Water Resources.

Fresno Metropolitan Flood Control District (FMFCD): Due to the subject parcel being located within FMFCD Drainage Area AN, project development will require payment of a \$13,918.00 Drainage Fee to FMFCD. If construction associated with this proposal disturbs more than one acre, compliance with the National Pollutant Discharge Elimination System (NPDES) General Permit for Discharges of Storm Water Associated with Construction Activity will be required. Should compliance with the NPDES General Permit for Discharges of Storm Water Associated with Construction Activity be required, before construction begins, the Applicant must submit to the State Water Resources Control Board a Notice of Intent to comply with said permit, a Storm Water Pollution Prevention Plan (SWPPP), a Site Plan, and appropriate fees. The SWPPP must include descriptions of measures taken to prevent or eliminate unauthorized non-storm water discharges, and best management practices (BMPs) implemented to prevent pollutants from discharging with storm water into waters of the United States. These requirements have been included as Project Notes. Outdoor storage areas shall be constructed and maintained in such a manner that material that may generate contaminants will be prevented from contact with rainfall and runoff, thereby preventing the conveyance of contaminants in runoff into the storm drain system. This requirement has been included as a Mitigation Measure to reduce potential impacts to water quality to less than significant.

Development Engineering Section of the Fresno County Department of Public Works and Planning: According to FEMA FIRM Panel 1565H, the project site is not subject to flooding from the 100-year storm. A Grading Permit or Voucher shall be required for any grading activity associated with this proposal. This requirement has been included as a Project Note.

No other comments specific to land use compatibility were expressed by reviewing Agencies or Departments.

Analysis:

This proposal entails the utilization of an existing 2,613 square-foot single-family residence located on a 2.50-acre parcel in the R-R(nb) (Rural Residential, two-acre minimum parcel size, Neighborhood Beautification Overlay) Zone District as a religious facility. No exterior modification or expansion of the existing single-family residence structure is proposed with this project. The proposed religious facility will host services for approximately 12 followers on Saturday and Sunday mornings, year round. These services will be conducted within the interior of the existing single-family residence, and no outdoor sound amplification is proposed with this project. Additionally, approximately 40 people will visit the site during the following annual special events:

- Buddha's Birthday, one Sunday in May from 9am – 2pm
- Annual Parents Gratitude Day, one Sunday usually in August from 9am – 2pm
- Chinese/Vietnamese Lunar New Year, one day usually in February from early morning to late afternoon

The subject parcel is located within the Sphere of Influence of the City of Fresno, is easterly adjacent to the city limits of the City of Fresno, and is located in a predominately urbanized area marked by residential subdivisions. Additionally, an elementary school (Central Unified McKinley Elementary School) is westerly adjacent to the subject parcel, a high school (Central Unified High School East Campus) is located approximately one and a half miles to the

northwest, and State Route (SR) 99 is located approximately two miles to the east. Considering the close proximity of another institutional use (i.e., Central Unified McKinley Elementary School) in conjunction with the fact that the proposed conversion of the existing single-family residence into a religious facility does not entail any exterior modification or expansion of said structure, staff does not believe this proposal will degrade the existing visual character or quality of the site and its surroundings. Further, the subject parcel is not located along a designated Scenic Highway, and no scenic vistas or scenic resources were identified in the analysis.

According to the Environmental Health Division of the Fresno County Department of Public Health, County records indicate that the septic system serving the existing single-family residence to be converted into the proposed religious facility is not adequate to serve the proposed use. Additionally, County records also indicate that the septic system serving the existing single-family residence is located on the south side of said structure, partially within the ultimate right-of-Way of McKinley Avenue. However, the Site Plan provided for this proposal shows the septic system serving the existing single-family residence being located on the east side of said structure. This is due to a previous property owner having abandoned the septic system identified on County records, and constructing the septic system identified on the Site Plan provided for this proposal. It is noted that no permits were obtained for either the abandonment of the septic system identified on County records or the construction of the septic system identified on the Site Plan provided for this proposal. In light of this situation, and considering the comments provided by the City of Fresno, the Applicant shall connect the proposed religious facility to the community sewer system operated by the City of Fresno prior to occupancy being granted for the proposed use.

The existing single-family residence to be converted into the proposed religious facility currently utilizes an existing water well located on the subject parcel. According to the City of Fresno Department of Public Utilities, the nearest City of Fresno water main available to serve the proposed use is located within Blythe Avenue, westerly adjacent to the subject parcel. Considering that a community water system is available to serve the proposed use, the existing single-family residence shall be connected to the community water system operated by the City of Fresno prior to occupancy being granted for the proposed use.

Based on the above information, and with adherence to the Mitigation Measures, recommended Conditions of Approval and mandatory Project Notes identified in the Initial Study (IS) prepared for this project and discussed in this Staff Report, staff finds that the proposal will not have an adverse effect upon surrounding properties.

Recommended Conditions of Approval:

See Recommended Conditions of Approval attached as Exhibit 1.

Conclusion:

Finding 3 can be made.

Finding 4: That the proposed development is consistent with the General Plan.

Relevant Policies:	Consistency/Considerations:
General Plan Policy LU-G.1: County acknowledges that the cities have primary responsibility for planning within their LAFCO-adopted Spheres of Influence and are	This proposal was reviewed by the City of Fresno Public Works Department which requested the following improvements within the limits of the project site: 1) concrete curb,

Relevant Policies:	Consistency/Considerations:
<p>responsible for urban development and the provision of urban services within their Spheres of Influence.</p>	<p>gutter, and sidewalk along the McKinley Avenue frontage and Blythe Avenue frontage of the subject parcel, constructed in compliance with City of Fresno Public Works Department Standard P-5 development criteria; 2) underground street lighting system constructed in compliance with City of Fresno Public Works Department Standard E-1, spacing and design shall conform to City of Fresno Public Works Department Standard E-7 for arterial roads; and 3) underground all existing overhead utilities.</p> <p>However, no substantial traffic hazard or substantial emergency access issue was identified by the City of Fresno to require such improvements under CEQA. Additionally, the portions of McKinley Avenue and Blythe Avenue which are contiguous with the subject parcel do not have any existing curbs, gutters or sidewalks. Further, the portions of McKinley Avenue and Blythe Avenue which are contiguous with the subject parcel do not have an existing street lighting system or underground utilities.</p> <p>According to the City of Fresno Department of Public Utilities, connection of the proposed religious facility to the community sewer system operated by the City of Fresno is required per Fresno Municipal Code (FMC) Section 6-303, and connection of the proposed religious facility to the community water system operated by the City of Fresno should also be required.</p> <p>Considering that community sewer and water systems are available to serve the proposed use, the existing single-family residence shall be connected to the community sewer and water systems operated by the City of Fresno prior to occupancy being granted for the proposed use.</p>
<p>General Plan Policy PF-C.17: County shall undertake a water supply evaluation, including determinations of water supply adequacy, impact on other water users in the County, and water sustainability.</p>	<p>This proposal was reviewed by the Water/Geology/Natural Resources Section of the Fresno County Department of Public Works and Planning, which expressed no concerns with the project, as the subject parcel is not located in a designated water-short area, and the proposed religious facility</p>

Relevant Policies:	Consistency/Considerations:
	will be required to utilize a community water system operated by the City of Fresno.

Reviewing Agency Comments:

Policy Planning Section of the Development Services Division: The subject parcel is designated Rural Residential in the County-adopted Fresno High-Roeding Community Plan.

No other comments specific to General Plan Policy were expressed by reviewing Agencies or Departments.

Analysis:

The subject parcel is designated Rural Residential in the County-adopted Fresno High-Roeding Community Plan and is zoned R-R(nb) (Rural Residential, two-acre minimum parcel size, Neighborhood Beautification Overlay). The Rural Residential General Plan designation accommodates religious facilities provided that the facilities are necessary to serve the needs of the rural residential population and occur in a manner compatible with the surrounding rural area. In this case, the proposal entails utilization of an existing 2,613 square-foot single-family residence as a religious facility on a 2.50-acre parcel located in a predominately urbanized area within the City of Fresno Sphere of Influence, approximately 40 feet east of the nearest city limits of the City of Fresno. No exterior modification or expansion of the existing single-family residence structure is proposed with this project. The proposed religious facility will host services for approximately 12 followers on Saturday and Sunday mornings, year round, and approximately 40 people will visit the site during three annual special events. Considering the relatively limited scope of this proposal, and the fact that no General Plan consistency issues were identified, staff believes the proposed use is consistent with the General Plan.

Based on the above information, the proposal is consistent with the Fresno County General Plan.

Recommended Conditions of Approval:

None.

Conclusion:

Finding 4 can be made.

PUBLIC COMMENT:

None.

CONCLUSION:

Based on the factors cited in the analysis, staff believes the required Findings for granting the Classified Conditional Use Permit Application can be made. Staff therefore recommends approval of Classified Conditional Use Permit Application No. 3478, subject to the recommended Conditions.

PLANNING COMMISSION MOTIONS:

Recommended Motion (Approval Action)

- Move to adopt the Mitigated Negative Declaration prepared for Initial Study Application No. 6888; and
- Move to determine the required Findings can be made and move to approve Classified Conditional Use Permit Application No. 3478, subject to the Mitigation Measures, Conditions of Approval and Project Notes listed in Exhibit 1; and
- Direct the Secretary to prepare a Resolution documenting the Commission's action.

Alternative Motion (Denial Action)

- Move to determine that the required Findings cannot be made (state basis for not making the Findings) and move to deny Classified Conditional Use Permit Application No. 3478; and
- Direct the Secretary to prepare a Resolution documenting the Commission's action.

Mitigation Measures, Recommended Conditions of Approval and Project Notes:

See attached Exhibit 1.

DC:ksn

G:\4360Devs&PIn\PROJSEC\PROJDOCS\CUP\3400-3499\3478\SR\CUP3478 SR.docx

Mitigation Monitoring and Reporting Program
Initial Study Application No. 6888 / Classified Conditional Use Permit Application No. 3478
(Including Conditions of Approval and Project Notes)

Mitigation Measures					
Mitigation Measure No.*	Impact	Mitigation Measure Language	Implementation Responsibility	Monitoring Responsibility	Time Span
*1.	Aesthetic	All lighting shall be hooded and directed as to not shine toward adjacent properties and public streets.	Applicant	Applicant/Fresno County Department of Public Works and Planning (PW&P)	Ongoing
*2.	Cultural Resources	In the event that cultural resources are unearthed during ground-disturbing activity, all work shall be halted in the area of the find, and an Archeologist shall be called to evaluate the findings and make any necessary mitigation recommendations. If human remains are unearthed during ground-disturbing activity, no further disturbance is to occur until the Fresno County Coroner has made the necessary findings as to origin and disposition. If such remains are determined to be Native American, the Coroner must notify the Native American Commission within 24 hours.	Applicant	Applicant	Ongoing
*3.	Geology and Soils	Construct an 8-inch sanitary sewer main (including sewer house branches to adjacent properties) in N. Blythe Avenue from the existing 15-inch sewer main in W. McKinley Avenue north across the project frontage.	Applicant	Applicant/City of Fresno	Ongoing
*4.	Geology and Soils	Construct a 15-inch sanitary sewer main (including sewer house branches to adjacent properties) in W. McKinley Avenue from the existing 15-inch sewer main at the intersection of W. McKinley and N. Blythe Avenue east across the project frontage.	Applicant	Applicant/City of Fresno	Ongoing
*5.	Geology and Soils	Any existing septic system located on the subject parcel shall be properly destroyed under permit and inspection by the Fresno County Department of Public Works and Planning prior to occupancy being granted for the proposed religious facility.	Applicant	Applicant/PW&P	Ongoing
*6.	Geology and Soils	Engineered improvement plans prepared by a Registered Civil Engineer shall be submitted for City of Fresno Department of Public Utilities review and approval for proposed additions to	Applicant	Applicant/City of Fresno	Ongoing

		the City sewer system.			
*7.	Geology and Soils	All public sanitary sewer facilities shall be constructed in accordance with City of Fresno Standards, Specifications, and Policies.	Applicant	Applicant/City of Fresno	Ongoing
*8.	Geology and Soils	Pay all applicable City of Fresno Sewer Connection Fees per the Fresno Municipal Code and the City of Fresno Master Fee Schedule.	Applicant	Applicant/City of Fresno	Ongoing
*9.	Hydrology and Water Quality	The existing single-family residence shall be connected to the community water system operated by the City of Fresno prior to occupancy being granted for the proposed religious facility.	Applicant	Applicant/City of Fresno	Ongoing
*10.	Hydrology and Water Quality	The Applicant shall provide the City of Fresno Department of Public Utilities with a detailed water usage analysis identifying water fixture, landscape, and laundry efficiencies to document water conservation design characteristics, subject to approval by the Director of the City of Fresno Department of Public Utilities.	Applicant	Applicant/City of Fresno	Ongoing
*11.	Hydrology and Water Quality	Installation of water service(s) and meter box(es) shall be required.	Applicant	Applicant/City of Fresno	Ongoing
*12.	Hydrology and Water Quality	Pay all applicable City of Fresno Water Connection Fees per the Fresno Municipal Code and the City of Fresno Master Fee Schedule.	Applicant	Applicant/City of Fresno	Ongoing
*13.	Hydrology and Water Quality	Seal and abandon any existing onsite water well in accordance with City of Fresno Standards and State of California Well Standards Bulletin 74-90, or current revisions issued by the California Department of Water Resources.	Applicant	Applicant/City of Fresno	Ongoing
*14.	Hydrology and Water Quality	Outdoor storage areas shall be constructed and maintained in such a manner that material that may generate contaminants will be prevented from contact with rainfall and runoff, thereby preventing the conveyance of contaminants in runoff into the storm drain system.	Applicant	Applicant/Fresno Metropolitan Flood Control District (FMFCD)	Ongoing
*15.	Trans. / Traffic	The Applicant shall record a document irrevocably offering 15 feet of the subject property to the County of Fresno as future right-of-way for McKinley Avenue (40 feet existing). The northern line of said offer shall establish the building setback line for future development. Note: A preliminary title report or lot book guarantee may be required before the irrevocable offer of dedication can be	Applicant	Applicant/PW&P	Ongoing

		processed. The property owner is advised that where deeds of trust or any other type of monetary liens exist on the property, the cost of obtaining a partial reconveyance, or any other document required to clear title to the property, shall be borne by the owner or developer. The County will prepare the irrevocable offer of dedication free of charge.			
*16.	Trans. / Traffic	The Applicant shall record a document irrevocably offering 33 feet and 23 feet of the subject property to the County of Fresno as future right-of-way for Blythe Avenue (20 to 30 feet existing). The eastern line of said offer shall establish the building setback line for future development. Note: A preliminary title report or lot book guarantee may be required before the irrevocable offer of dedication can be processed. The property owner is advised that where deeds of trust or any other type of monetary liens exist on the property, the cost of obtaining a partial reconveyance, or any other document required to clear title to the property, shall be borne by the owner or developer. The County will prepare the irrevocable offer of dedication free of charge.	Applicant	Applicant/PW&P	Ongoing
*17.	Trans. / Traffic	All parking and circulation areas shall be surfaced with asphalt concrete (AC) paving prior to occupancy being granted for the proposed religious facility.	Applicant	Applicant/PW&P	Ongoing

Conditions of Approval

1.	Development of the property shall be in accordance with the Site Plans, Floor Plans, Elevations, and Operational Statement approved by the Planning Commission.
2.	Prior to occupancy, a Site Plan Review shall be submitted to and approved by the Department of Public Works and Planning in accordance with Section 874 of the Fresno County Zoning Ordinance. Conditions of the Site Plan Review may include: design of parking and circulation areas, access, on-site grading and drainage, fire protection, landscaping, signage, lighting and right-of-way dedication.

*MITIGATION MEASURE – Measure specifically applied to the project to mitigate potential adverse environmental effects identified in the environmental document. Conditions of Approval reference recommended Conditions for the project.

Notes

The following Notes reference mandatory requirements of Fresno County or other Agencies and are provided as information to the project Applicant.	
1.	Plans related to construction and development of the project prepared by a licensed design professional shall be submitted to the Development Services Division of the Fresno County Department of Public Works and Planning for review and approval in order to acquire building and installation permits, and necessary inspections.

Notes	
2.	20-foot by 20-foot corner cutoffs shall be maintained for sight distance purposes at any driveway accessing McKinley Avenue or Blythe Avenue.
3.	An Encroachment Permit shall be required from the Road Maintenance and Operations Division for any work performed within the County right-of-way.
4.	Due to the subject parcel being located within Fresno Metropolitan Flood Control District (FMFCD) Drainage Area AN, project development will require payment of a \$13,918.00 Drainage Fee to FMFCD.
5.	If construction associated with this proposal disturbs more than one acre, compliance with the National Pollutant Discharge Elimination System (NPDES) General Permit for Discharges of Storm Water Associated with Construction Activity will be required. Should compliance with the NPDES General Permit for Discharges of Storm Water Associated with Construction Activity be required, before construction begins, the Applicant must submit to the State Water Resources Control Board a Notice of Intent to comply with said permit, a Storm Water Pollution Prevention Plan (SWPPP), a Site Plan, and appropriate fees. The SWPPP must include descriptions of measures taken to prevent or eliminate unauthorized non-storm water discharges, and best management practices (BMP) implemented to prevent pollutants from discharging with storm water into waters of the United States.
6.	A Grading Permit or Voucher shall be required for any grading activity associated with this proposal.

DC:ksn
G:\4360Devs&Pln\PROJSEC\PROJDOCS\CUP\3400-3499\3478\SR\CUP3478 MMRP (Ex 1).docx

LOCATION MAP

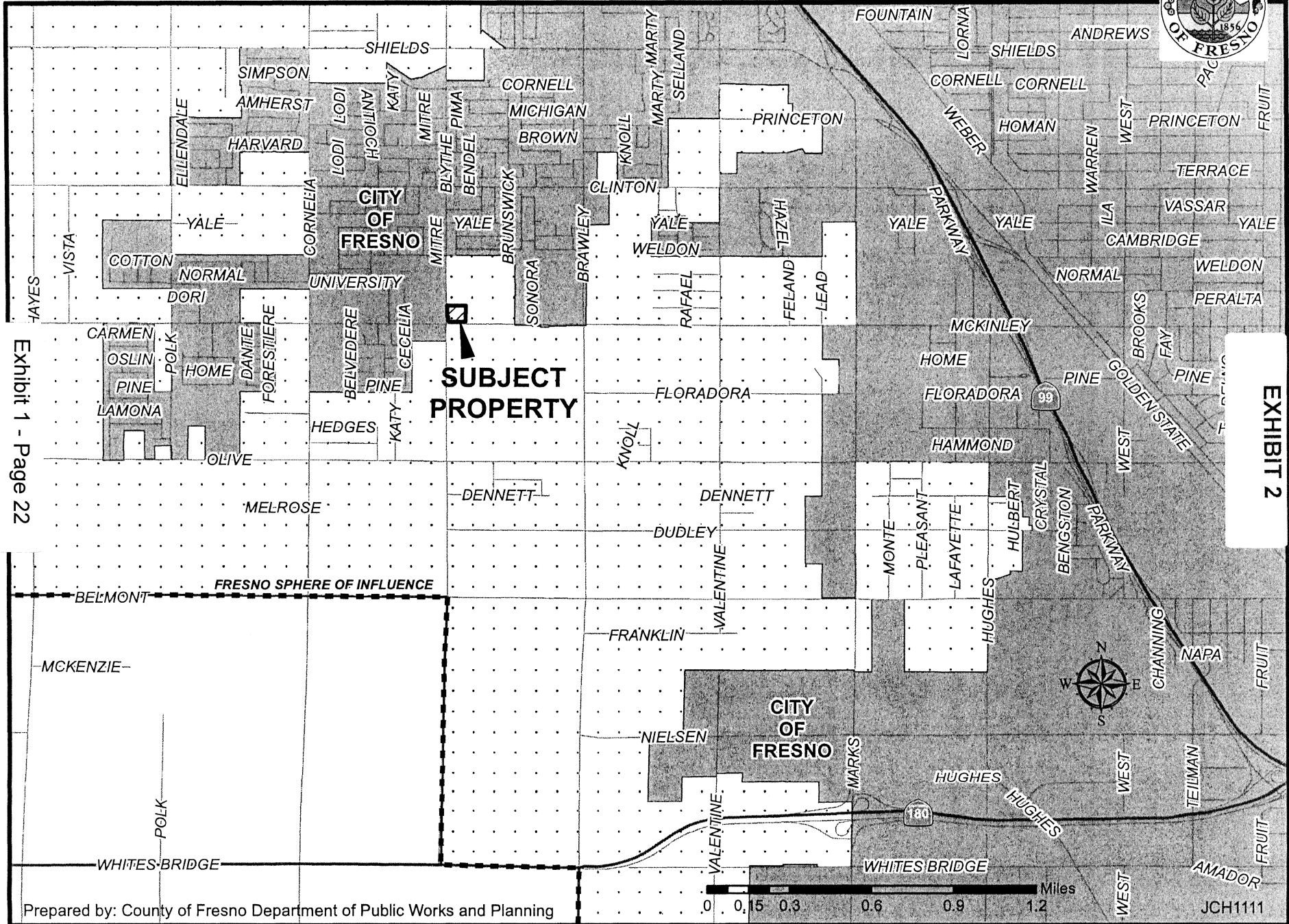
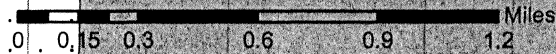

Exhibit 1 - Page 22

EXHIBIT 2



EXISTING ZONING MAP

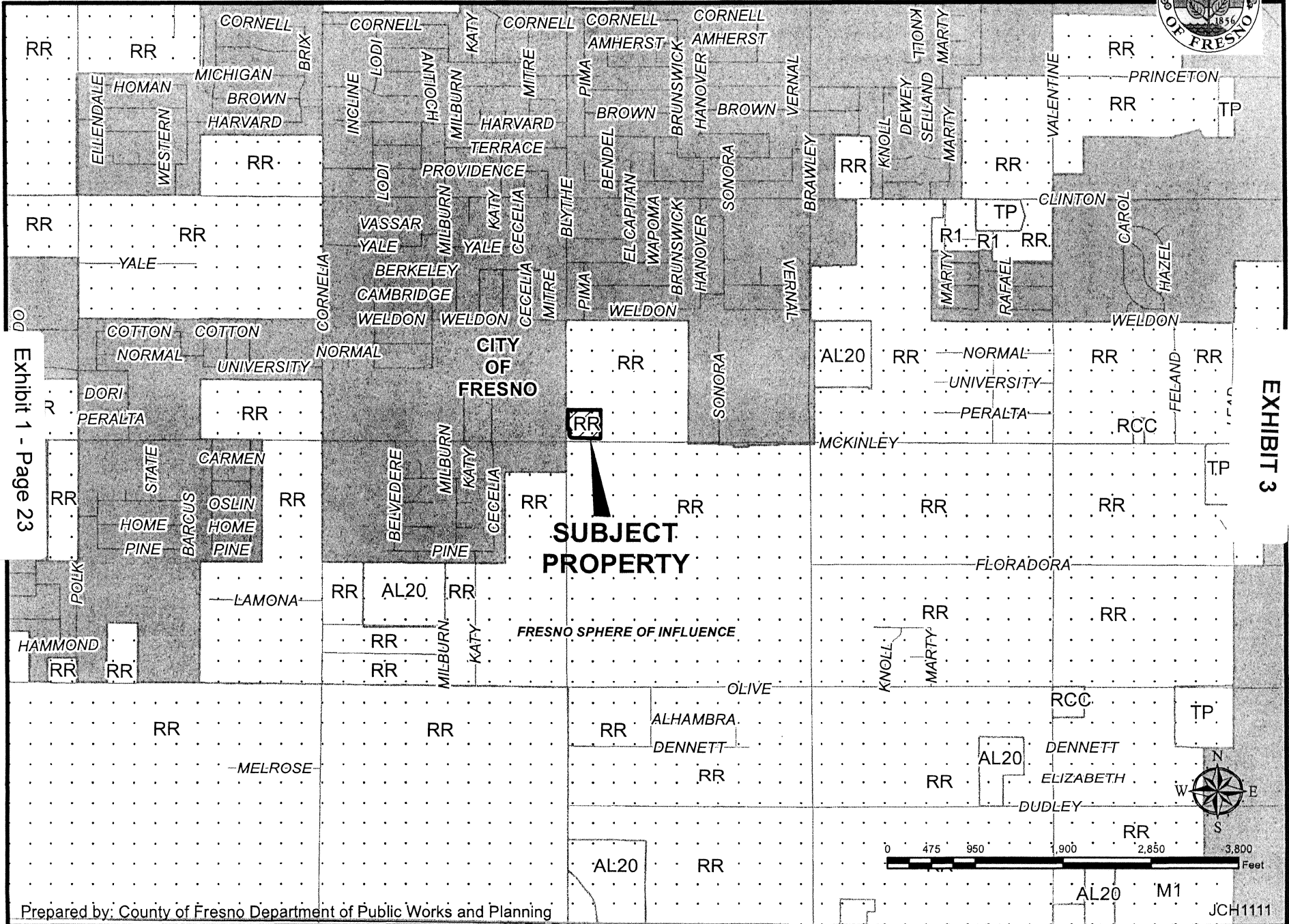

Exhibit 1 - Page 23

EXHIBIT 3

PROJECT

EXISTING LAND USE MAP

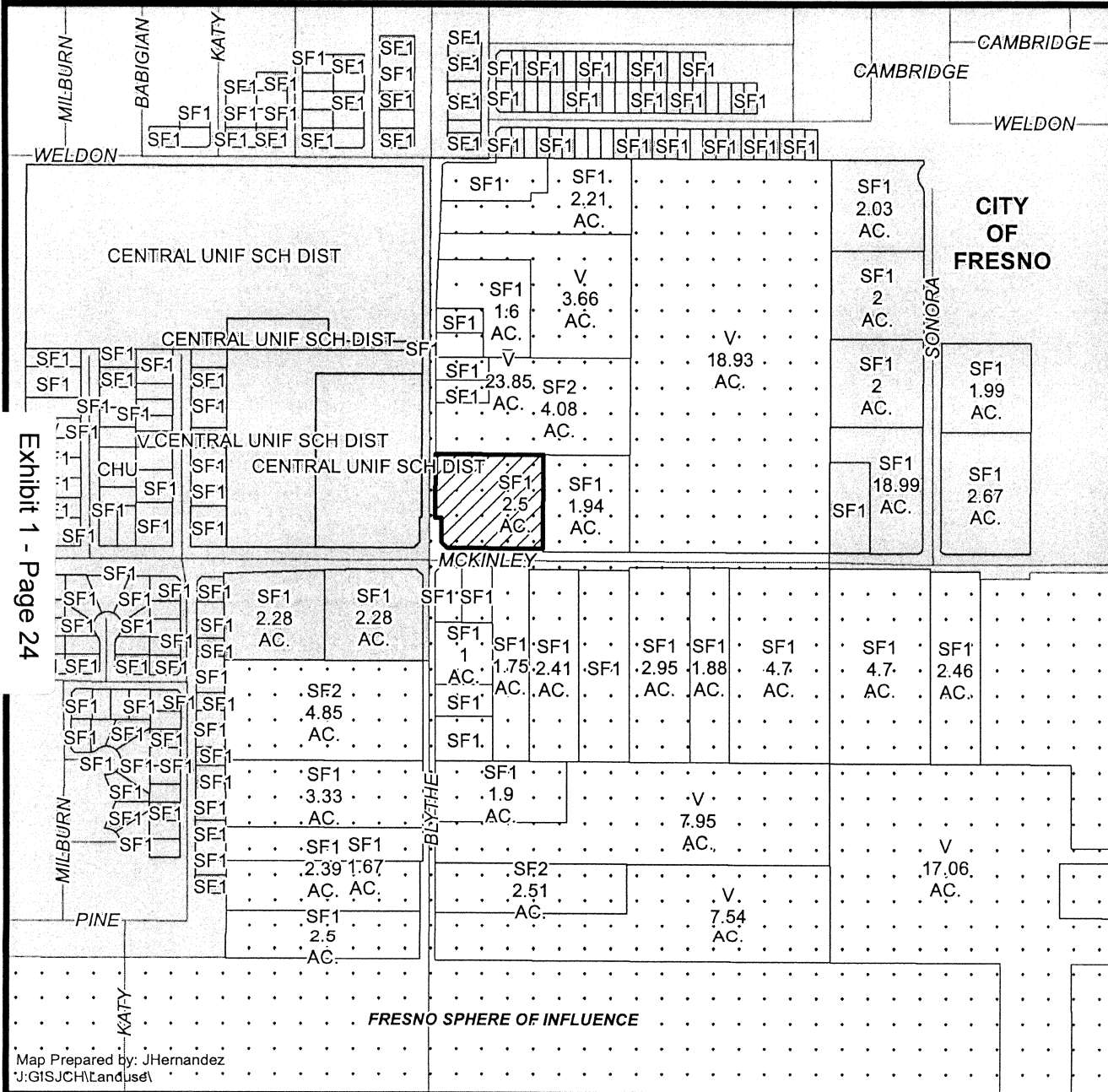

Exhibit 1 - Page 24

LEGEND

- CHU - CHURCH
- SF# - SINGLE FAMILY RESIDENCE
- V - VACANT

LEGEND:

 Subject Property

EXHIBIT 4

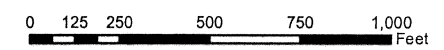
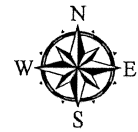

Department of Public Works and Planning
Development Services Division

Map Prepared by: JHernandez
J:GISJCH\LandUse\

EXHIBIT 5

PREPARED BY:
 THANH NGUYEN
 FRESNO, CA --
 (310) 972-0548

CONDITIONAL USE PERMIT FOR:
 SYN. LE

JOB NUMBER: 01
 DATE: 08/31/14
 DRAWN BY: NGUYEN THANG
 SCALE: 1" = 20'-0"

SITE PLAN

REVISIONS	DATE

A-1.0

NOTES

1. LOCATION OF EXISTING PROPERTY LINE.
2. LOCATION OF EXISTING AC PAVING TO REMAIN.
3. LOCATION OF EXISTING DRIVE APPROACH AND GATE TO REMAIN.
4. LOCATION OF EXISTING CONCRETE FLUTED TO REMAIN.
5. LOCATION OF EXISTING LANDSCAPE AREA TO REMAIN.
6. LOCATION OF EXISTING 200 AMP ELECTRICAL PANEL TO REMAIN.
7. LOCATION OF EXISTING 640 FEET TO REMAIN.
8. LOCATION OF EXISTING 4'-0" CHAIN LINK FENCE TO REMAIN.
9. LOCATION OF EXISTING SEPTIC TANK TO REMAIN.
10. LOCATION OF EXISTING TREE(S) TO REMAIN.
11. LOCATION OF EXISTING HELL TO REMAIN.
12. DASHED LINES INDICATE "PATH OF TRAVEL" FROM NON-ACCURABLE PROPERTY TO EXISTING PROPERTY AS SHOWN ON PLANNING MAP WITH 2% MINIMUM GRADE SLOPE.
13. CROSS HATCHED AREA INDICATES LOCATION OF PROPOSED SANCTUARY (SEE PLANNING MAP ONLY) - REFER TO FLOOR PLAN (A-10) FOR ADDITIONAL INFORMATION.
14. LOCATION OF NEW AC PAVING - 4" AC PAVING OVER 4" COMPACTED SUBGRADE WITH 1% MINIMUM SLOPE TO ADJACENT DRIVEWAY OR PAVING EDGE, CURB, TYPICAL, AND TYPICAL PATTERN.
15. GENERAL CONTRACTOR SHALL PROVIDE A SMOOTH TRANSITION FROM EXISTING TO NEW PAVING - REFER TO DETAILS FOR ADDITIONAL INFORMATION.
16. LOCATION OF NEW 4" HIDE STRIP PAINTED TRAFFIC WHITE.
17. LOCATION OF NEW 12" HIGH LETTERS PAINTED TRAFFIC WHITE STATING "NO PARKING AS SHOWN".
18. CONCRETE DRIVEWAY AND DRIVEWAY APPROACH SHALL BE FINISHED WITH PAINTED WHITE WELL STRIPES AT 6" DEGREES AND AT 30" OC THROUGHOUT WITH "NO PARKING" TIME.
19. LOCATION OF NEW 4" HIDE STRIP PAINTED TRAFFIC WHITE TO BE USED FOR ADDITIONAL INFORMATION AND REQUIREMENTS.
20. LOCATION OF NEW 4" HIDE STRIP PAINTED TRAFFIC WHITE TO BE USED FOR ADDITIONAL INFORMATION AND REQUIREMENTS.
21. LOCATION OF NEW 4" HIDE STRIP PAINTED TRAFFIC WHITE TO BE USED FOR ADDITIONAL INFORMATION AND REQUIREMENTS.
22. LOCATION OF NEW 4" HIDE STRIP PAINTED TRAFFIC WHITE TO BE USED FOR ADDITIONAL INFORMATION AND REQUIREMENTS.
23. DASHED CROSS-HATCHING INDICATES LOCATION OF NON-REQUIRED LEVEL GRADING/PAVING ZONES (2% THROUGHOUT SLOPE IN ANY DIRECTION).
24. LOCATION OF NEW 4" HIDE STRIP PAINTED TRAFFIC WHITE TO BE USED FOR ADDITIONAL INFORMATION AND REQUIREMENTS.

PROJECT DATA

GENERAL DATA:
 SITE ADDRESS: 4384 W. MCKENLEY AVE
 FRESNO, CA 93722
 COUNTY OF FRESNO
 APN: 017-020-010-000
 ZONE: R1
 SEWER: SEWER
 WATER: WATER
 GAS: GAS
 ELECTRIC: ELECTRIC

SITE DATA:
 LOT SIZE: 7.60 ACRES
 TOTAL AREA: 330,000 SQ. FT.
 TOTAL ACCURABLE PARKING STALLS: 5 STALLS

PARKING DATA:
 PROPOSED SANCTUARY AREA: 704 SQ. FT.
 EXISTING SANCTUARY AREA: 1,000 SQ. FT.
 EXISTING BUILDING AREA: 400 SQ. FT.
 EXISTING PATIO AREA: 400 SQ. FT.
 TOTAL BUILDING AREA: 1,400 SQ. FT.

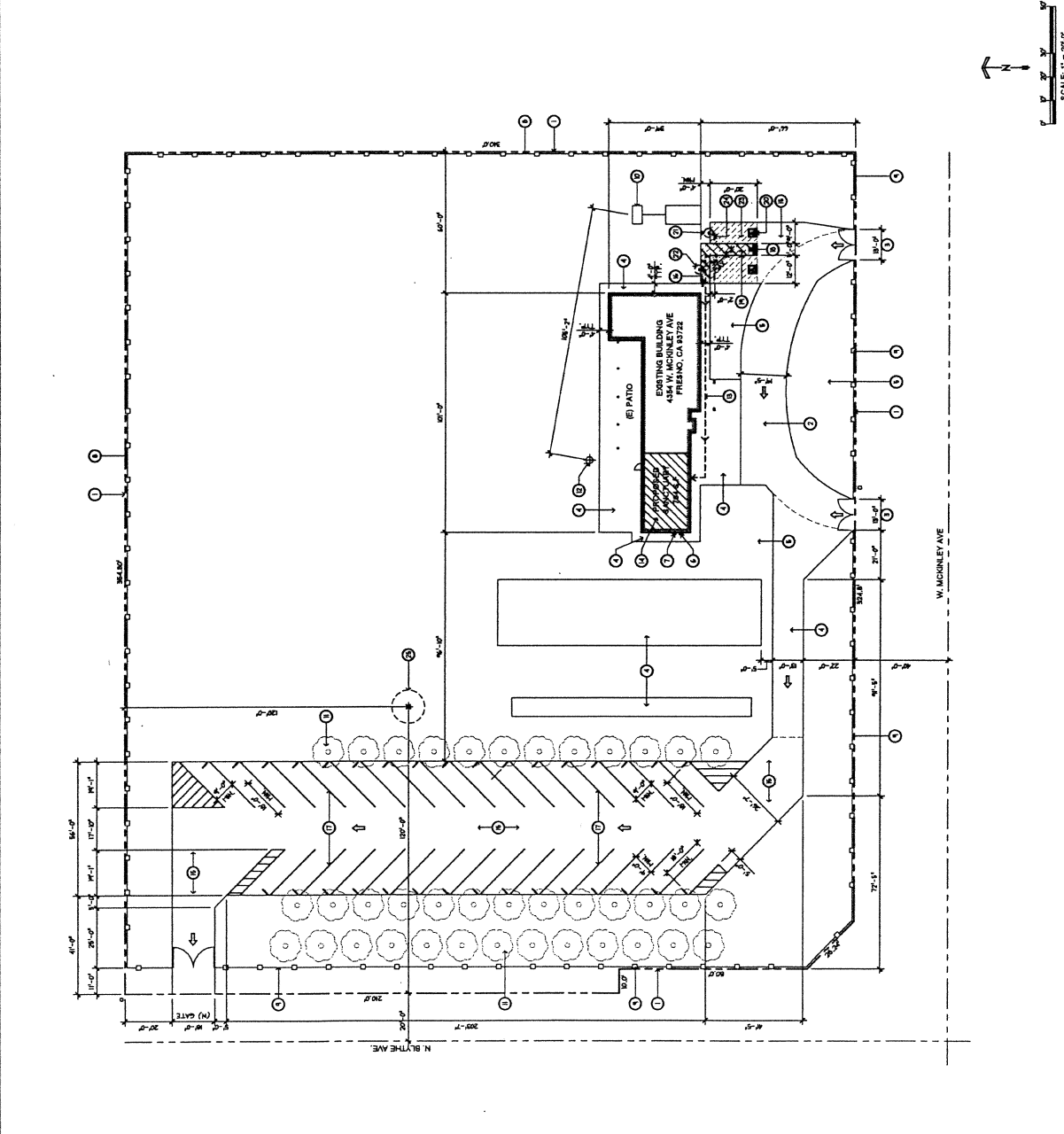
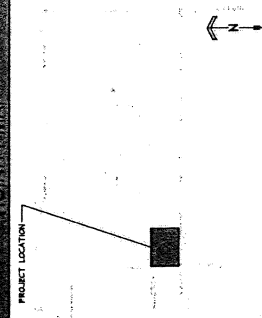

EXHIBIT 9

PREPARED BY: **THANH NGUYEN**
 --
 FRESNO, CA --
 (310) 972-0548

CONDITIONAL USE PERMIT FOR:
 SY N, LE
 427 W. ...

JOB NUMBER: 01
 DATE: 08/16/14
 DRAWN BY: T. NGUYEN
 SCALE: 1/2" = 1'-0"

FLOOR PLAN

REVISIONS

A-2.0

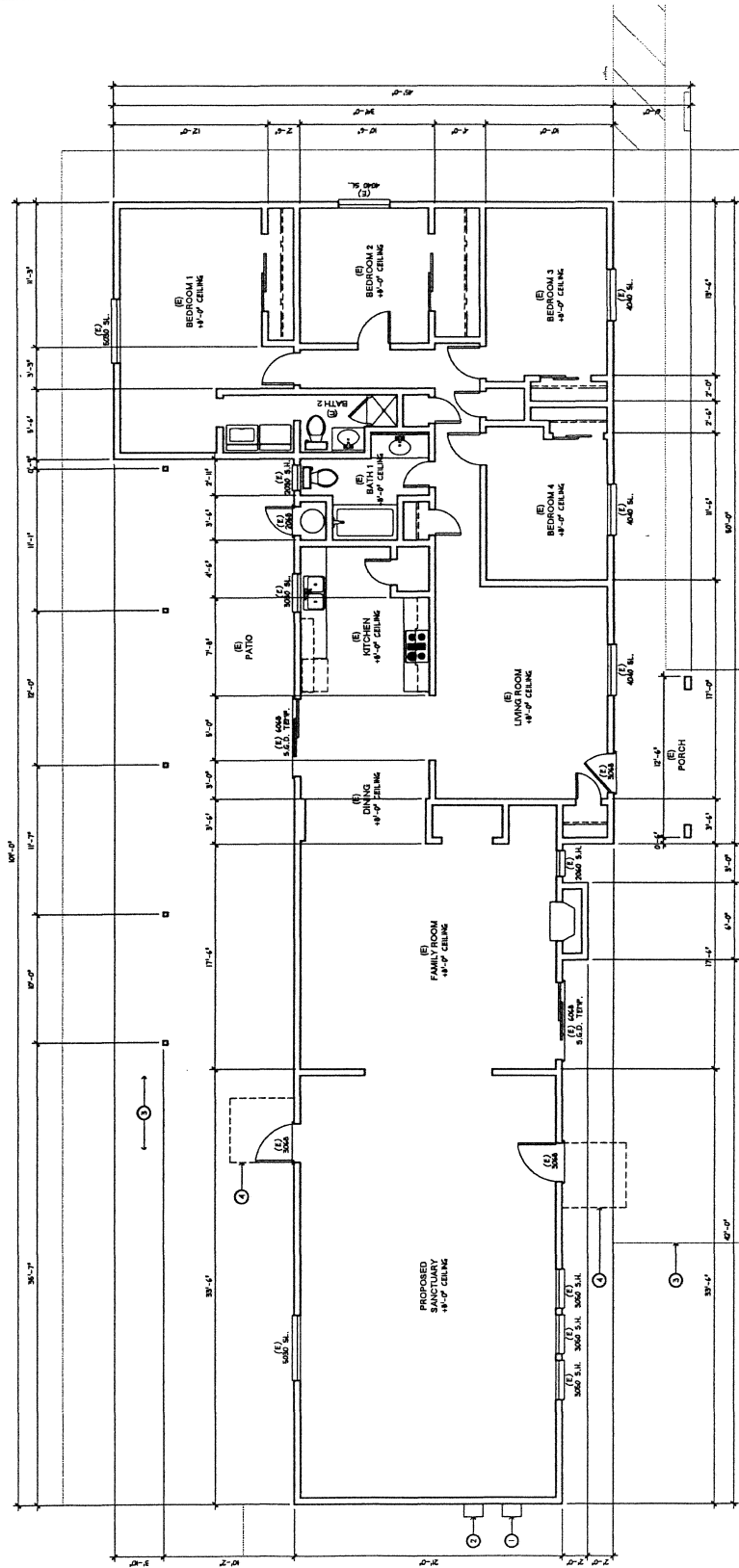

REVISIONS

1 LOCATION OF EXISTING 200 AMP ELECTRICAL PANEL TO BE REPAIR.
 2 LOCATION OF EXISTING GAS METER TO BE REPAIR.
 3 LOCATION OF EXISTING CONCRETE PATHWORK - REFER TO SITE PLAN FOR ADDITIONAL INFORMATION.
 4 LOCATION OF 8'-0" x 7'-0" PRIMARY LEVEL CONCRETE LANDING AT ENTRY TO PORCH & PORCH ESCAPE FOR 8'-0" FRONT ENTRY FRONT BALCONY.

GENERAL DATA:
 SITE ADDRESS: 484 N. ROCKLEY AVE
 LOCAL JURISDICTION: FRESNO, CA 93704
 COUNTY OF FRESNO
 PROPERTY MAP NO.
 ZONING: 1410
 DATE: 8/16/14

PARCELS DATA:
 LOT AREA: 230 ACRES
 TOTAL AREA: 230 ACRES
 TOTAL AREA: 230 ACRES

BUILDINGS DATA:
 PROPOSED SANCTUARY AREA: 1,090 SQ. FT.
 EXISTING SANCTUARY AREA: 1,090 SQ. FT.
 PATIO AREA: 400 SQ. FT.
 TOTAL BUILDING AREA: 1,490 SQ. FT.

ASSEMBLY WITHOUT FIRED SEATS:
 SANCTUARY (CONCENTRATED) - 704 S.F. / 18 - 18 OCCUPANTS
 CHAIRS ONLY (NOT FIRED)
 TOTAL OCCUPANTS - 18
 TOTAL OCCUPANTS - 18
 TOTAL OCCUPANTS - 18

GENERAL NOTES:
 1. REFER TO SITE PLAN FOR LOCATION OF EXISTING ELECTRICAL PANEL TO BE REPAIR.
 2. REFER TO SITE PLAN FOR LOCATION OF EXISTING GAS METER TO BE REPAIR.
 3. REFER TO SITE PLAN FOR LOCATION OF EXISTING CONCRETE PATHWORK - REFER TO SITE PLAN FOR ADDITIONAL INFORMATION.
 4. REFER TO SITE PLAN FOR LOCATION OF 8'-0" x 7'-0" PRIMARY LEVEL CONCRETE LANDING AT ENTRY TO PORCH & PORCH ESCAPE FOR 8'-0" FRONT ENTRY FRONT BALCONY.

PREPARED BY:
 THANH NGUYEN
 FRESNO, CA --
 (310) 972-0548

EXHIBIT 7

CONDITIONAL USE PERMIT FOR:
 SY N. LE
 435

JOB NUMBER: 01
 DATE: 04/19/14
 DRAWN BY: THANH NGUYEN
 SCALE: 1/4" = 1'-0"

EXTERIOR ELEVATIONS

REVISIONS	DATE

A-3.0

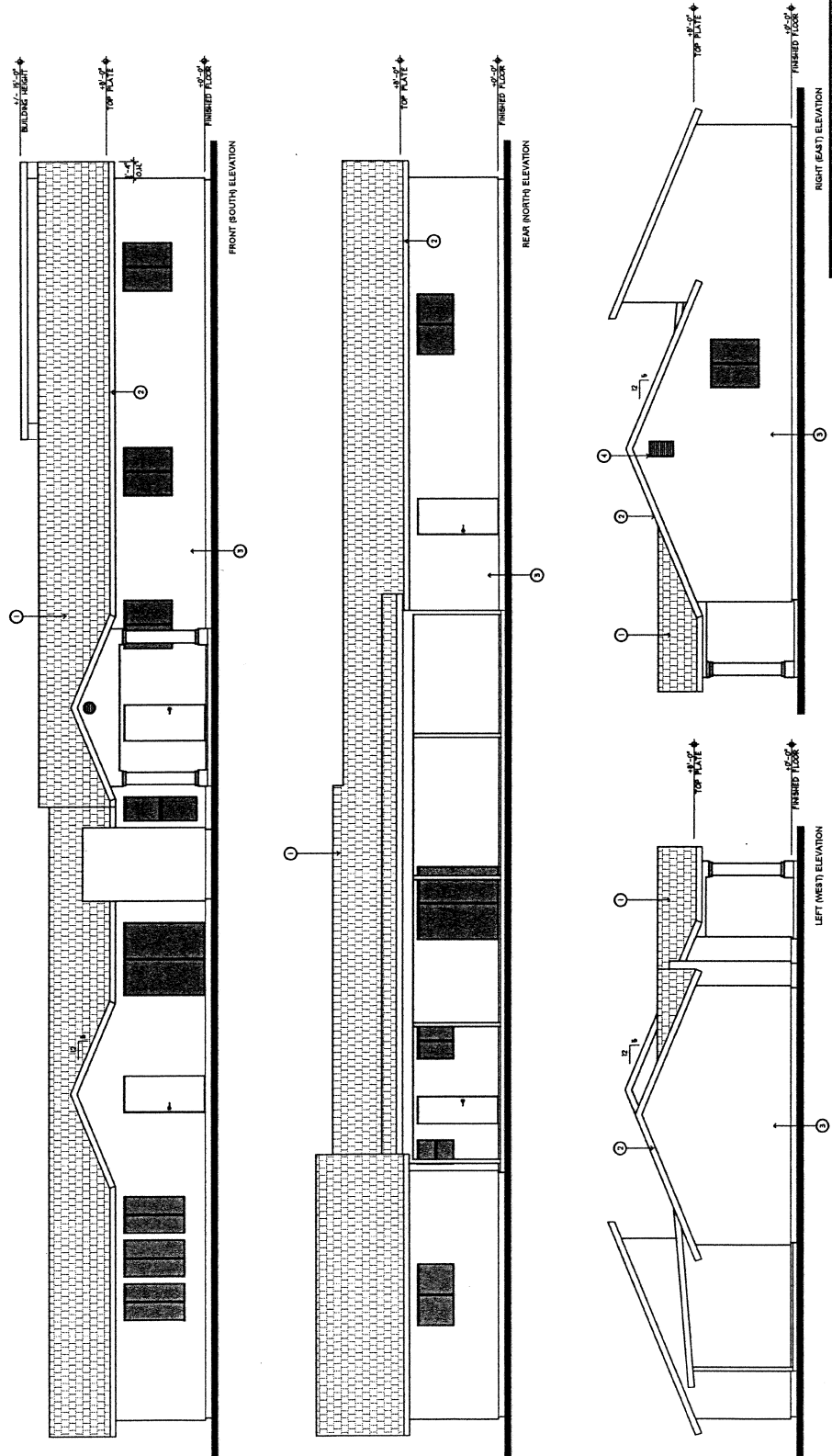

- NOTES**
- 1 INDICATES EXISTING ASPHALT COMPOSITION ROOFING TO BE REPAIRED
 - 2 INDICATES EXISTING 2X FASCIA BOARDS TO BE REPAIRED
 - 3 INDICATES EXISTING 7/8" GYPSUM PLASTER TO BE REPAIRED
 - 4 INDICATES EXISTING GABLE END VOID TO BE REPAIRED

EXHIBIT 8

THIEN AN BUDDHIST TEMPLE AND CULTURAL CENTER OF FRESNO

Board of Directors

Mr. Sy Nguyen Le, President
Mr. Vuong Tran, Vice-President
Mr. Truc Van Nguyen, Secretary
Ms. Kimyen T. Pham, Treasurer

OPERATIONAL STATEMENT

NATURE OF THE OPERATION

Thien An Buddhist Temple and Cultural Center of Fresno is a non-profit religious organization (California Corporate No. 3612911) located at 4354 W. McKinley Avenue, Fresno, CA 93722. We request the County to allow a religious facility in this residential home, a place to provide Buddhist worship service and activities such as praying, meditating, and practicing Buddha's teachings.

OPERATIONAL TIME LIMITS AND NUMBER OF PEOPLE

The Temple consists of a resident monk, living on-site as a caretaker, and twelve regular followers. These regular followers, lead by the monk, get together in the morning of Saturdays and Sundays to practice Buddha's teachings, and perform meditation and Buddhist praying. Once in a while the temple will have guests, estimated around 40 people, coming from Fresno and the vicinity to celebrate some special annual ceremonies such as:

- a. Buddha's birthday ceremony, occurring on one Sunday of May, from 9 AM to 2 PM
- b. Annual Parents (especially Mothers) Gratitude Day ceremony, normally on a Sunday of August, from 9 AM to 2 PM
- c. Chinese/Vietnamese Lunar New Year, usually on a day at the beginning of February, from early morning to late afternoon

ACCESS TO THE SITE, PARKING FACILITY AND VEHICLE CIRCULATION

The temple does not produce anything and there are no goods or merchandise to be sold on-site. No equipment is used and no supplies or materials are used or stored on-site. There will be no service and delivery vehicles; there are only passenger vehicles from the priest and from the religious followers.

The property currently has two existing entrances on McKinley Avenue, connected to each other by an asphalt concrete paved driveway. A new asphalt concrete paved parking, as shown on the site plan, is proposed including parking stalls for disabled persons. Also a new driveway, served as exit only, is proposed along Blythe Avenue, near the northwest corner of the lot, as shown on the site plan.

PHYSICAL CHARACTERISTICS OF THE SITE

No new building or addition is proposed to the current facility. The existing home building is shown in the attached elevation drawings. The current living room, as indicated on the floor plan, will be used as the worship/sanctuary area. All Buddhist teaching, meditation and praying practices will be performed inside the facility.

The requested worship/sanctuary area and the religious practices will not result in any unsightly appearance, nor produce noise, glare, dust or odor. There will be no outdoor lighting or outdoor sound amplification system used for this facility.

Existing trees and landscaping and fencing are to remain, as shown on the site plan. The home has its own well for water usage and its own septic system, as identified on the site plan.



EXHIBIT 9

County of Fresno

DEPARTMENT OF PUBLIC WORKS AND PLANNING
ALAN WEAVER, DIRECTOR

EVALUATION OF ENVIRONMENTAL IMPACTS

- APPLICANT: Sy Nguyen Le
- APPLICATION NOS.: Initial Study Application No. 6888 and Classified Conditional Use Permit Application No. 3478
- DESCRIPTION: Allow an approximately 3,939 square-foot religious facility with related improvements on a 2.50-acre parcel in the R-R (nb) (Rural Residential, two-acre minimum parcel size, Neighborhood Beautification Overlay) Zone District.
- LOCATION: The subject parcel is located on the northeast corner of McKinley Avenue and Blythe Avenue, approximately 40 feet east of the nearest city limits of the City of Fresno (4354 W. McKinley Avenue) (Sup. Dist.: 1) (APN: 312-082-14).

I. AESTHETICS

- A. Would the project have a substantial adverse effect on a scenic vista; or
- B. Would the project substantially damage scenic resources, including, but not limited to, trees, rock outcroppings, and historic buildings within a State scenic highway; or
- C. Would the project substantially degrade the existing visual character or quality of the site and its surroundings?

FINDING: LESS THAN SIGNIFICANT IMPACT:

This proposal entails the utilization of an existing 2,613 square-foot single-family residence located on a 2.50-acre parcel in the R-R(nb) (Rural Residential, two-acre minimum parcel size, Neighborhood Beautification Overlay) Zone District as a religious facility. No exterior modification or expansion of the existing single-family residence structure is proposed with this project. The proposed religious facility will host services for approximately 12 followers on Saturday and Sunday mornings, year round. These services will be conducted within the interior of the existing single-family residence, and no outdoor sound amplification is proposed with this project. Additionally, approximately 40 people will visit the site during the following annual special events:

- *Buddha's Birthday, one Sunday in May from 9am – 2pm*
- *Annual Parents Gratitude Day, one Sunday usually in August from 9am – 2pm*
- *Chinese/Vietnamese Lunar New Year, one day usually in February from early morning to late afternoon*

The subject parcel currently has access from McKinley Avenue via two existing 13-foot wide paved driveways. The proposed religious facility will utilize these existing driveways in conjunction with a proposed paved parking lot with 32 paved parking spaces and a proposed 18-foot wide paved driveway on Blythe Avenue that will be utilized for exit only.

The subject parcel is located within the sphere-of-influence of the City of Fresno, is easterly adjacent to the city limits of the City of Fresno, and is located in a predominately urbanized area marked by residential subdivisions. Additionally, an elementary school (Central Unified McKinley Elementary School) is westerly adjacent to the subject parcel, a high school (Central Unified High School East Campus) is located approximately one and a half miles to the northwest, and State Route (SR) 99 is located approximately two miles to the east. Considering the close proximity of another institutional use (i.e. Central Unified McKinley Elementary School) in conjunction with the fact that the proposed conversion of the existing single-family residence into a religious facility does not entail any exterior modification or expansion of said structure, staff does not believe this proposal will degrade the existing visual character or quality of the site and its surroundings. Further, the subject parcel is not located along a designated Scenic Highway, and no scenic vistas or scenic resources were identified in the analysis.

- D. Would the project create a new source of substantial light or glare which would adversely affect day or nighttime views in the area?

FINDING: LESS THAN SIGNIFICANT IMPACT WITH MITIGATION INCORPORATED:

This proposal does not include a request to utilize outdoor lighting. However, in order to ensure that the proposed religious facility will not generate new sources of light and glare in the area, a Mitigation Measure will be included to require any outdoor lighting utilized at the proposed religious facility to be hooded and directed as to not shine towards adjacent properties and public streets.

* **Mitigation Measure**

1. *All outdoor lighting shall be hooded and directed as to not shine towards adjacent properties and public streets.*

II. AGRICULTURAL AND FORESTRY RESOURCES

- A. Would the project convert prime or unique farmlands or farmland of state-wide importance to non-agricultural use; or
- B. Would the project conflict with existing agricultural zoning or Williamson Act Contracts; or
- C. Would the project conflict with existing zoning for or cause rezoning of forest land, timberland, or timberland zoned Timberland Production; or

- D. Would the project result in the loss of forest land or conversion of forest land to non-forest use; or
- E. Would the project involve other changes in the existing environment which, due to their location or nature, could result in conversion of Farmland to non-agricultural uses or conversion of forest land to non-forest use?

FINDING: NO IMPACT:

The subject parcel is located in a predominately urbanized area marked by residential subdivisions. Further, the subject parcel is not located on forest land, is classified as Rural Residential Land on the Fresno County Important Farmland Map (2012), and is not enrolled under a Williamson Act contract. As such, staff believes that this proposal will result in no impact to agricultural or forestry resources.

III. AIR QUALITY

- A. Would the project conflict with or obstruct implementation of the applicable Air Quality Plan; or
- B. Would the project isolate any air quality standard or contribute to an existing or projected air quality violation; or
- C. Would the project result in a cumulatively considerable net increase of any criteria pollutant for which the project region is non-attainment under a Federal or State ambient air quality standard; or
- D. Would the project expose sensitive receptors to substantial pollutant concentrations; or
- E. Would the project create objectionable odors affecting a substantial number of people?

FINDING: LESS THAN SIGNIFICANT IMPACT:

This proposal was reviewed by the San Joaquin Valley Unified Air Pollution Control District (Air District), which did not express any concerns related to the project. However, staff notes that this proposal may be subject to the following Air District Rules: Regulation VIII (Fugitive Dust Rules), Rule 4102 (Nuisance), Rule 4601 (Architectural Coatings), Rule 4641 (Cutback, Slow Cure, and Emulsified Asphalt, Paving and Maintenance Operations), and Rule 4002 (National Emission Standards for Hazardous Air Pollutants). Compliance with Air District Rules will reduce air quality impacts of the subject proposal to less than significant.

IV. BIOLOGICAL RESOURCES

- A. Would the project have a substantial adverse effect, either directly or through habitat modifications, on any candidate, sensitive, or special-status species; or

- B. Would the project have a substantial adverse effect on any riparian habitat or other sensitive natural community identified in local or regional plans, policies, regulations, or by the California Department of Fish and Wildlife (CDFW) or U.S. Fish and Wildlife Service (USFWS); or
- C. Would the project have a substantial adverse effect on federally-protected wetlands as defined by Section 404 of the Clean Water Act through direct removal, filling, hydrological interruption or other means; or
- D. Would the project interfere substantially with the movement of any native resident or migratory fish or wildlife species or with established native resident or migratory wildlife corridors, or impede the use of native wildlife nursery sites; or
- E. Would the project conflict with any local policies or ordinances protecting biological resources, such as a tree preservation policy or ordinance; or
- F. Would the project Conflict with the provisions of an adopted Habitat Conservation Plan, Natural Community Conservation Plan, or other approved local regional, or state habitat conservation plan?

FINDING: LESS THAN SIGNIFICANT IMPACT:

The subject parcel is located in a predominately urbanized area marked by residential subdivisions, and has been previously disturbed as said property has been improved with a single-family residence. Additionally, neighboring properties have also been improved with single-family residences and/or school-related improvements. As such, neighboring properties have also been previously disturbed. This proposal was referred to the U.S. Fish and Wildlife Service (USFWS), which did not express any concerns related to the project. This proposal was also referred to the California Department of Fish and Wildlife (CDFW), which also did not identify any concerns related to the project. Therefore, no impacts were identified in regard to: 1) any candidate, sensitive, or special-status species; 2) any riparian habitat or other sensitive natural community identified in local or regional plans, policies, regulations, or by the CDFW or USFWS; 3) Federally protected wetlands as defined by Section 404 of the Clean Water Act; and 4) the movement of any native resident or migratory fish or wildlife species or with established native resident or migratory wildlife corridors, or impede the use of native wildlife nursery sites. This proposal will not conflict with any local policies or ordinances protecting biological resources or any provisions of an adopted Habitat Conservation Plan, Natural Community Conservation Plan, or other approved local, regional, or state Habitat Conservation Plan.

V. CULTURAL RESOURCES

- A. Would the project cause a substantial adverse change in the significance of a historical resource as defined in Section 15064.5; or
- B. Would the project cause of substantial adverse change in the significance of an archeological resource pursuant to Section 15064.5; or

- C. Would the project directly or indirectly destroy a unique paleontological resource or site or unique geologic feature; or
- D. Would the project disturb any human remains, including those interred outside of formal cemeteries?

FINDING: LESS THAN SIGNIFICANT IMPACT WITH MITIGATION INCORPORATED:

The subject parcel is not located within proximity of any area designated to be highly or moderately sensitive for archeological resources. However, in the event that cultural resources are unearthed during ground disturbing activity, all work shall be halted in the area of the find, and an Archeologist shall be utilized to evaluate the findings and make any necessary mitigation recommendations. If human remains are unearthed during ground disturbing activity, no further disturbance is to occur until the Fresno County Coroner has made the necessary findings as to origin and disposition of the remains. If such remains are determined to be Native American, the Coroner must notify the Native American Commission within 24 hours. A Mitigation Measure reflecting this requirement has been incorporated into the project. The Mitigation Measure will reduce potential impacts to cultural resources to less than significant.

* **Mitigation Measure**

1. *In the event that cultural resources are unearthed during ground disturbing activity, all work shall be halted in the area of the find, and an Archeologist shall be utilized to evaluate the findings and make any necessary mitigation recommendations. If human remains are unearthed during ground disturbing activity, no further disturbance is to occur until the Fresno County Coroner has made the necessary findings as to origin and disposition. If such remains are determined to be Native American, the Coroner must notify the Native American Commission within 24 hours.*

VI. GEOLOGY AND SOILS

- A. Would the project expose people or structures to potential substantial adverse effects, including risk of loss, injury or death involving:
 1. Rupture of a known earthquake; or
 2. Strong seismic ground shaking; or
 3. Seismic-related ground failure, including liquefaction; or
 4. Landslides?

FINDING: NO IMPACT:

The area in which the subject parcel is located is designated as Seismic Design Category C in the California Geological Survey. No agency expressed concerns related to ground shaking, ground failure, liquefaction or landslides. Development of the project will be subject to the Seismic Design Category C Standards.

- B. Would the project result in substantial erosion or loss of topsoil?

FINDING: LESS THAN SIGNIFICANT IMPACT:

The subject parcel has predominately flat topography and while changes in topography and erosion may result from grading activities associated with this proposal, it is not likely. According to the Development Engineering Section of the Fresno County Department of Public Works and Planning, the Applicant must obtain a Grading Permit or Grading Voucher for any grading associated with this proposal.

- C. Would the project result in on-site or off-site landslide, lateral spreading, subsidence, liquefaction or collapse; or
- D. Would the project be located on expansive soils, creating substantial risks to life or property?

FINDING: NO IMPACT:

The subject parcel is not located within an area of known risk of landslides, lateral spreading, subsidence, liquefaction, collapse, or within an area of known expansive soils.

- E. Would the project have soils incapable of adequately supporting the use of septic tanks or alternative disposal systems where sewers are not available for wastewater disposal?

FINDING: LESS THAN SIGNIFICANT IMPACT WITH MITIGATION INCORPORATED:

According to the Environmental Health Division of the Fresno County Department of Public Health, County records indicate that the septic system serving the existing single-family residence to be converted into the proposed religious facility is not adequate to serve the proposed use. Additionally, County records also indicate that the septic system serving the existing single-family residence is located on the south side of said structure, partially within the ultimate Right-of-Way of McKinley Avenue. However, the Site Plan provided for this proposal shows the septic system serving the existing single-family residence being located on the east side of said structure. This is due to a previous property owner having abandoned the septic system identified on County records, and constructing the septic system identified on the Site Plan provided for this proposal. It is noted that no permits were obtained for either the abandonment of the septic system identified on County records or the construction of the septic system identified on the Site Plan provided for this proposal.

According to the City of Fresno Department of Public Utilities, connection of the proposed religious facility to the community sewer system operated by the City of Fresno is required per Fresno Municipal Code (FMC) Section 6-303. The nearest City of Fresno sewer main in relation to the subject parcel terminates at the intersection of Blythe Avenue and McKinley Avenue. Connection of the proposed religious facility to the community sewer system operated by the City of Fresno shall be completed prior to occupancy being granted for the proposed use. Further, connection of the proposed religious facility to the community sewer system operated by the City of Fresno has the following requirements that the Applicant must abide by, which are included as Mitigation Measures to reduce potential impacts to soils to less than significant:

* **Mitigation Measures**

1. Construct an 8-inch sanitary sewer main (including sewer house branches to adjacent properties) in N. Blythe Avenue from the existing 15-inch sewer main in W. McKinley Avenue north across the project frontage.
2. Construct a 15-inch sanitary sewer main (including sewer house branches to adjacent properties) in W. McKinley Avenue from the existing 15-inch sewer main at the intersection of W. McKinley and N. Blythe Avenue east across the project frontage.
3. Any existing septic system located on the subject parcel shall be properly destroyed under permit and inspection by the Fresno County Department of Public Works and Planning prior to occupancy being granted for the proposed religious facility.
4. Engineered improvement plans prepared by a Registered Civil Engineer shall be submitted for City of Fresno Department of Public Utilities review and approval for proposed additions to the City sewer system.
5. All public sanitary sewer facilities shall be constructed in accordance with City of Fresno Standards, Specifications, and Policies.
6. Pay all applicable City of Fresno Sewer Connection Fees per the Fresno Municipal Code and the City of Fresno Master Fee Schedule.

VII. GREENHOUSE GAS EMISSIONS

- A. Would the project generate greenhouse gas emissions, either directly or indirectly, that may have a significant impact on the environment; or
- B. Would the project conflict with any applicable plan, policy or regulation adopted for the purpose of reducing the emissions of greenhouse gases?

FINDING: LESS THAN SIGNIFICANT IMPACT:

The San Joaquin Valley Unified Air Pollution Control District (Air District) reviewed this proposal and expressed no concerns related to greenhouse gas emissions. Further, compliance with Air District Rules and Regulations discussed in Section III (Air Quality) of this analysis will reduce air quality impacts from the subject proposal to less than significant.

VIII. HAZARDS AND HAZARDOUS MATERIALS

- A. Would the project create a significant public hazard through routine transport, use or disposal of hazardous materials; or
- B. Would the project create a significant public hazard involving accidental release of hazardous materials into the environment; or
- C. Would the project create hazardous emissions or utilize hazardous materials, substances or waste within one quarter-mile of a school?

FINDING: LESS THAN SIGNIFICANT IMPACT:

With regard to the conversion of the existing single-family residence to a religious facility, the Fresno County Department of Public Health, Environmental Health Division has consistently provided comments for such conversion proposals which state that any active rodent or insect infestation must be abated prior to remodeling the structure in order to prevent the spread of vectors to adjacent properties. Additionally, in the process of remodeling the existing single-family residence, the contractor may encounter asbestos containing construction materials and materials coated with lead based paints. Should such materials be encountered, the San Joaquin Valley Unified Air Pollution Control District (Air District) must be contacted for more information. Further, if lead-based paint is suspected to have been used in the existing residence structure, the contractor must contact the following agencies for current regulations and requirements prior to demolition and/or remodel work: a) California Department of Public Health, Childhood Lead Poisoning Prevention Branch; b) United States Environmental Protection Agency, Region 9; c) California Industrial Relations Department, Division of Occupational Safety and Health, Consultation Service. Additionally, any construction materials deemed hazardous as identified in the remodel process shall be characterized and disposed of in accordance with current federal, state, and local requirements.

It is noted that an elementary school (Central Unified McKinley Elementary School) is westerly adjacent to the subject parcel.

- D. Would the project be located on a hazardous materials site?

FINDING: NO IMPACT:

No hazardous materials sites are located within the boundaries of the subject parcel.

- E. Would a project located within an airport land use plan or, absent such a plan, within two miles of a public airport or public use airport, result in a safety hazard for people residing or working in the project area; or
- F. Would a project located within the vicinity of a private airstrip result in a safety hazard for people residing or working in the project area?

FINDING: NO IMPACT:

The subject parcel is not located within an Airport Land Use Plan or in the vicinity of a public or private use airport.

- G. Would the project impair implementation of or physically interfere with an adopted Emergency Response Plan or Emergency Evacuation Plan?

FINDING: NO IMPACT:

This proposal will not impair the implementation of, or physically interfere with an adopted Emergency Response Plan.

- H. Would the project expose people or structures to a significant risk of loss, injury or death involving wildland fires, including where wildlands are adjacent to urbanized areas or where residences are intermixed with wildlands?

FINDING: NO IMPACT:

The subject parcel is not located within a wildland area.

IX. HYDROLOGY AND WATER QUALITY

- A. Would the project violate any water quality standards or waste discharge requirements or otherwise degrade water quality?

FINDING: LESS THAN SIGNIFICANT IMPACT:

According to the Fresno Metropolitan Flood Control District, if construction associated with this proposal disturbs more than one acre, compliance with the National Pollutant Discharge Elimination System (NPDES) General Permit for Discharges of Storm Water Associated with Construction Activity will be required. Should compliance with the NPDES General Permit for Discharges of Storm Water Associated with Construction Activity be required, before construction begins, the Applicant must submit to the State Water Resources Control Board a Notice of Intent to comply with said permit, a Storm Water Pollution Prevention Plan (SWPPP), a Site Plan, and appropriate fees. The SWPPP must include descriptions of measures taken to prevent or eliminate unauthorized non-storm water discharges, and best management practices (BMP) implemented to prevent pollutants from discharging with storm water into waters of the United States.

- B. Would the project substantially deplete groundwater supplies or interfere substantially with groundwater recharge so that there would be a net deficit in aquifer volume or a lowering of the local groundwater table?

FINDING: LESS THAN SIGNIFICANT IMPACT WITH MITIGATION INCORPORATED:

The existing single-family residence to be converted into the proposed religious facility currently utilizes an existing water well located on the subject parcel. According to the City of Fresno Department of Public Utilities, the nearest City of Fresno water main available to serve the proposed use is located within Blythe Avenue, westerly adjacent to the subject parcel. Considering that a community water system is available to serve the proposed use, the existing single-family residence shall be connected to the community water system operated by the City of Fresno prior to occupancy being granted for the proposed use. Further, connection of the proposed religious facility to the community water system operated by the City of Fresno has the following requirements that the Applicant must abide by, which are included as Mitigation Measures to reduce potential impacts to groundwater to less than significant:

* **Mitigation Measures**

1. *The existing single-family residence shall be connected to the community water system operated by the City of Fresno prior to occupancy being granted for the proposed religious facility.*
2. *The Applicant shall provide the City of Fresno Department of Public Utilities with a detailed water usage analysis identifying water fixture, landscape, and laundry efficiencies to document water conservation design characteristics, subject to approval by the Director of the City of Fresno Department of Public Utilities.*
3. *Installation of water service(s) and meter box(es) shall be required.*
4. *Pay all applicable City of Fresno Water Connection Fees per the Fresno Municipal Code and the City of Fresno Master Fee Schedule.*
5. *Seal and abandon any existing onsite water well in accordance with City of Fresno Standards and State of California Well Standards Bulletin 74-90, or current revisions issued by the California Department of Water Resources.*

This proposal was reviewed by the Water/Geology/Natural Resources Section of the Fresno County Department of Public Works and Planning, which expressed no concerns with the project as the subject parcel is not located in a designated water-short area, and the proposed religious facility will be required to utilize a community water system operated by the City of Fresno.

- C. Would the project substantially alter existing drainage patterns, including alteration of the course of a stream or river, in a manner which would result in substantial erosion or siltation on or off site; or

- D. Would the project substantially alter existing drainage patterns, including alteration of the course of a stream or river, in a manner which would result in flooding on or off site?

FINDING: NO IMPACT:

No streams or rivers are located near the subject parcel.

- E. Would the project create or contribute run-off which would exceed the capacity of existing or planned storm water drainage systems or provide substantial additional sources of polluted run-off?

FINDING: LESS THAN SIGNIFICANT IMPACT WITH MITIGATION INCORPORATED:

Permanent improvements associated with the development of the proposed religious facility will not cause significant changes in absorption rates, drainage patterns or the rate and amount of surface run-off, with adherence to the Grading and Drainage Sections of the Fresno County Ordinance Code.

According to the Fresno Metropolitan Flood Control District (FMFCD), due to the subject parcel being located within FMFCD Drainage Area AN, project development will require payment of a \$13,918.00 Drainage Fee. Additionally, outdoor storage areas shall be constructed and maintained in such a manner that material that may generate contaminants will be prevented from contact with rainfall and runoff, thereby preventing the conveyance of contaminants in runoff into the storm drain system. This requirement will be included as a Mitigation Measure to reduce potential impacts to water quality to less than significant.

* **Mitigation Measure**

- 1. Outdoor storage areas shall be constructed and maintained in such a manner that material that may generate contaminants will be prevented from contact with rainfall and runoff, thereby preventing the conveyance of contaminants in runoff into the storm drain system.*

- F. Would the project otherwise substantially degrade water quality?

FINDING: NO IMPACT:

No additional water quality impacts were identified in the project analysis.

- G. Would the project place housing within a 100-year floodplain; or

- H. Would the project place structures within a 100-year flood hazard area that would impede or redirect flood flows?

FINDING: NO IMPACT:

According to FEMA FIRM Panel 1565H, the project site is not subject to flooding from the 100-year storm.

- I. Would the project expose persons or structures to levee or dam failure; or
- J. Would the project cause inundation by seiche, tsunami or mudflow?

FINDING: NO IMPACT:

The subject parcel is not prone to seiche, tsunami or mudflow, nor is the subject parcel exposed to potential levee or dam failure.

X. LAND USE AND PLANNING

- A. Will the project physically divide an established community?

FINDING: NO IMPACT:

This proposal will not physically divide a community. The subject parcel is located approximately 40 feet east of the nearest city limits of the City of Fresno.

- B. Will the project conflict with any Land Use Plan, policy or regulation of an agency with jurisdiction over the project?

FINDING: LESS THAN SIGNIFICANT IMPACT:

The subject parcel is designated Rural Residential in the County-adopted Fresno High-Roeding Community Plan and is zoned R-R(nb) (Rural Residential, two-acre minimum parcel size, Neighborhood Beautification Overlay). The Rural Residential General Plan designation accommodates religious facilities provided that the facilities are necessary to serve the needs of the rural residential population and occur in a manner compatible with the surrounding rural area. In this case, the proposal entails utilization of an existing 2,613 square-foot single-family residence as a religious facility on a 2.50-acre parcel located in a predominately urbanized area within the City of Fresno sphere-of-influence, approximately 40 feet east of the nearest city limits of the City of Fresno. No exterior modification or expansion of the existing single-family residence structure is proposed with this project. The proposed religious facility will host services for approximately 12 followers on Saturday and Sunday mornings, year round, and approximately 40 people will visit the site during three annual special events. Considering the relatively limited scope of this proposal, staff believes the proposed use is consistent with the General Plan.

- C. Will the project conflict with any applicable Habitat Conservation Plan or Natural Community Conservation Plan?

FINDING: NO IMPACT:

This proposal will not conflict with any Land Use Plan or habitat or Natural Community Conservation Plan. No such Plans were identified in the project analysis.

XI. MINERAL RESOURCES

- A. Would the project result in the loss of availability of a known mineral resource; or
- B. Would the project result in the loss of availability of a locally-important mineral resource recovery site designated on a General Plan?

FINDING: NO IMPACT:

No mineral resource impacts were identified in the project analysis. The subject parcel is not located in an identified mineral resource area identified in Policy OS-C.2 of the General Plan.

XII. NOISE

- A. Would the project result in exposure of people to severe noise levels; or
- B. Would the project result in exposure of people to or generate excessive ground-borne vibration or ground-borne noise levels; or
- C. Would the project cause a substantial permanent increase in ambient noise levels in the project vicinity; or
- D. Would the project result in a substantial temporary or periodic increase in ambient noise levels?

FINDING: LESS THAN SIGNIFICANT IMPACT:

The proposed religious facility will host services for approximately 12 followers on Saturday and Sunday mornings, year round. These services will be conducted within the interior of the existing single-family residence to be utilized as the proposed religious facility, and no outdoor sound amplification is proposed with this project. Additionally, approximately 40 people will visit the site during three annual special events. The proposed use must comply with the Noise Element of the Fresno County General Plan and the Fresno County Noise Ordinance, thereby minimizing noise impacts to less than significant.

- E. Would the project expose people to excessive noise levels associated with a location near an airport or a private airstrip; or
- F. For a project within the vicinity of a private airstrip, would the project expose people residing or working in the project area to excessive noise levels?

FINDING: NO IMPACT:

The subject parcel is not located in the vicinity of a public airport or private airstrip, and is not impacted by airport noise.

XIII. POPULATION AND HOUSING

- A. Would the project induce substantial population growth either directly or indirectly; or
- B. Would the project displace substantial numbers of existing housing; or
- C. Would the project displace substantial numbers of people, necessitating the construction of housing elsewhere?

FINDING: NO IMPACT:

This proposal will not result in an increase of housing, nor will it otherwise induce population growth.

XIV. PUBLIC SERVICES

- A. Would the project result in substantial adverse physical impacts associated with the provision of new or physically-altered public facilities in the following areas:
 - 1. Fire protection?

FINDING: LESS THAN SIGNIFICANT IMPACT:

This proposal was reviewed by the North Central Fire Protection District for requirements related to water supply, fire hydrants, and fire apparatus access. No concerns were expressed by said agency. Review of this proposal by the North Central Fire Protection District for compliance with fire and life safety requirements for the interior of the existing single-family residence to be utilized as the proposed religious facility will be conducted by said agency. Any development associated with this proposal must comply with the California Code of Regulations Title 24 – Fire Code.

- 2. Police protection; or
- 3. Schools; or
- 4. Parks; or
- 5. Other public facilities?

FINDING: NO IMPACT:

No impacts on the provision of other services were identified in the project analysis.

XV. RECREATION

- A. Would the project increase the use of existing neighborhood and regional parks; or
- B. Would the project require the construction of or expansion of recreational facilities?

FINDING: NO IMPACT:

No such impacts were identified in the project analysis.

XVI. TRANSPORTATION/TRAFFIC

- A. Would the project conflict with any applicable plan, ordinance or policy establishing measures of effectiveness for the performance of the circulation system, taking into account all modes of transportation; or
- B. Would the project conflict with an applicable congestion management program, including, but not limited to, level of service standards and travel demands measures?

FINDING: LESS THAN SIGNIFICANT IMPACT WITH MITIGATION INCORPORATED:

The subject parcel currently has access from McKinley Avenue via two existing 13-foot wide paved driveways. The proposed religious facility will utilize these existing driveways in conjunction with a proposed paved parking lot with 32 paved parking spaces and a proposed 18-foot wide paved driveway on Blythe Avenue that will be utilized for exit only.

The proposed religious facility will host services for approximately 12 followers on Saturday and Sunday mornings, year round, and approximately 40 people will visit the site during three annual special events, which include Buddha's Birthday (one Sunday in May from 9am – 2pm), Annual Parents Gratitude Day (one Sunday usually in August from 9am – 2pm), and Chinese/Vietnamese Lunar New Year (one day usually in February from early morning to late afternoon). As such, the proposed use may generate approximately 24 one-way visitor trips (12 round trips) for religious services on Saturdays and Sundays, year round, and approximately 80 one-way visitor trips (40 round trips) per each of the three annual special events. This proposal was reviewed by the Design Division of the Fresno County Department of Public Works and Planning, which expressed no traffic related concerns regarding the project, nor did said agency require preparation of a Traffic Impact Study (TIS).

According to the Road Maintenance and Operations Division of the Fresno County Department of Public Works and Planning, McKinley Avenue is a County-maintained road with an existing 40-foot right-of-way north of the section line which fronts the subject parcel. Due to McKinley Avenue being classified as an Arterial, McKinley Avenue has an ultimate right-of-way of 106 feet at the subject parcel, with 53 feet north and 53 feet south of the section line. As such, an irrevocable offer of 13 feet of additional right-of-way dedication is needed from the southern side of the subject parcel which abuts McKinley Avenue. Additionally, Blythe Avenue is jointly maintained by the

County and City of Fresno, and the portion of Blythe Avenue that fronts the subject parcel has a variable existing right-of-way which ranges from 20 to 30 feet east of the center line. Due to Blythe Avenue being classified as an Arterial, Blythe Avenue has an ultimate right-of-way of 106 feet at the subject parcel, with 53 feet east and 53 feet west of the center line. As such, irrevocable offers of 33 feet and 23 feet of additional right-of-way dedication are needed from the western side of the subject parcel which abuts Blythe Avenue. These requirements for additional right-of-way dedication will be included as Mitigation Measures to reduce potential impacts to transportation to less than significant.

* **Mitigation Measures**

1. The Applicant shall record a document irrevocably offering 15 feet of the subject property to the County of Fresno as future right-of-way for McKinley Avenue (40 feet existing). The northern line of said offer shall establish the building setback line for future development.

Note: A preliminary title report or lot book guarantee may be required before the irrevocable offer of dedication can be processed. The property owner is advised that where deeds of trust or any other type of monetary liens exist on the property, the cost of obtaining a partial reconveyance, or any other document required to clear title to the property, shall be borne by the owner or developer. The County will prepare the irrevocable offer of dedication free of charge.

2. The Applicant shall record a document irrevocably offering 33 feet and 23 feet of the subject property to the County of Fresno as future right-of-way for Blythe Avenue (20 to 30 feet existing). The eastern line of said offer shall establish the building setback line for future development.

Note: A preliminary title report or lot book guarantee may be required before the irrevocable offer of dedication can be processed. The property owner is advised that where deeds of trust or any other type of monetary liens exist on the property, the cost of obtaining a partial reconveyance, or any other document required to clear title to the property, shall be borne by the owner or developer. The County will prepare the irrevocable offer of dedication free of charge.

- C. Would the project result in a change in air traffic patterns?

FINDING: NO IMPACT:

This proposal will not result in a change in air traffic patterns. No such impacts were identified in the project analysis.

- D. Would the project substantially increase traffic hazards due to design features; or

- E. Would the project result in inadequate emergency access?

FINDING: LESS THAN SIGNIFICANT IMPACT WITH MITIGATION INCORPORATED:

The City of Fresno Public Works Department reviewed this proposal and commented that the Applicant should be required to provide a concrete curb, gutter, and sidewalk along the McKinley Avenue frontage and Blythe Avenue frontage of the subject parcel, constructed in compliance with the City of Fresno Public Works Department Standard P-5 development criteria. However, no substantial traffic hazard or substantial emergency access issue was identified by the City of Fresno to require such improvements under CEQA. Further, the portions of McKinley Avenue and Blythe Avenue which are contiguous with the subject parcel do not have any existing curbs, gutters or sidewalks.

According to the Road Maintenance and Operations Division of the Fresno County Department of Public Works and Planning, the Applicant must obtain an Encroachment Permit from the Road Maintenance and Operations Division for all improvements within the County right-of-way. Further, all parking and circulation areas shall be surfaced with asphalt concrete (AC) paving. This requirement will be included as a Mitigation Measure to reduce potential impacts to transportation to less than significant.

* **Mitigation Measure**

1. *All parking and circulation areas shall be surfaced with asphalt concrete (AC) paving prior to occupancy being granted for the proposed religious facility.*

- F. Would the project conflict with adopted plans, policies or programs regarding public transit, bicycle or pedestrian facilities or otherwise decrease the performance or safety of such facilities?

FINDING: NO IMPACT:

This proposal will not conflict with any adopted alternative transportation plans. No such impacts were identified in the project analysis.

XVII. UTILITIES AND SERVICE SYSTEMS

- A. Would the project exceed wastewater treatment requirements; or
- B. Would the project require construction of or the expansion of new water or wastewater treatment facilities?

FINDING: LESS THAN SIGNIFICANT IMPACT WITH MITIGATION INCORPORATED:

See discussion in Section VI.E Geology and Soils.

- C. Would the project require or result in the construction or expansion of new storm water drainage facilities?

FINDING: LESS THAN SIGNIFICANT IMPACT WITH MITIGATION INCORPORATED:

See discussion in Section IX.E Hydrology and Water Quality.

- D. Would the project have sufficient water supplies available from existing entitlements and resources, or are new or expanded entitlements needed?

FINDING: LESS THAN SIGNIFICANT IMPACT WITH MITIGATION INCORPORATED:

See discussion in Section IX.B Hydrology and Water Quality.

- E. Would the project result in a determination of inadequate wastewater treatment capacity to serve project demand; or

FINDING: LESS THAN SIGNIFICANT IMPACT WITH MITIGATION INCORPORATED:

See discussion in Section VI.E Geology and Soils.

- F. Would the project be served by a landfill with sufficient permitted capacity; or

- G. Would the project comply with federal, state and local statutes and regulations related to solid waste?

FINDING: NO IMPACT:

No such impacts were identified in the project analysis.

XVIII. MANDATORY FINDINGS OF SIGNIFICANCE

- A. Does the project have the potential to degrade the quality of the environment, substantially reduce the habitat of a fish or wildlife species, cause a fish or wildlife population to drop below self-sustaining levels, threaten to eliminate a plant or animal community, reduce the number or restrict the range of a rare or endangered plant or animal, or eliminate important examples of the major periods of California prehistory or history?

FINDING: LESS THAN SIGNIFICANT IMPACT WITH MITIGATION INCORPORATED:

Development of the project may impact aesthetics. The included Mitigation Measure in Section I (Aesthetics) will minimize such impacts to less than significant. Pursuant to discussion in Section IV (Biological Resources), no such impacts on biological resources were identified in the project analysis. Development of the project may impact cultural resources. The included Mitigation Measure in Section V (Cultural Resources) will minimize such impacts to less than significant. Development of the project may impact geology and soils. The included Mitigation Measures in Section VI (Geology and Soils) will minimize such impacts to less than significant. Development of the project may impact hydrology and water quality. The included Mitigation Measures in Section IX (Hydrology and Water Quality) will minimize such impacts to less than significant. Development of the project may impact transportation and traffic. The included Mitigation Measures in Section XVI (Transportation/Traffic) will minimize such impacts to less than significant.

- B. Does the project have impacts that are individually limited, but cumulatively considerable?

FINDING: NO IMPACT:

No cumulatively considerable impacts were identified in the project analysis.

- C. Does the project have environmental impacts which will cause substantial adverse effects on human beings, either directly or indirectly?

FINDING: NO IMPACT:

No substantial adverse impacts on human beings were identified in the project analysis.

CONCLUSION/SUMMARY

Based upon the Initial Study prepared for Classified Conditional Use Permit Application No. 3478, staff has concluded that the project will not have a significant effect on the environment. It has been determined that there would be no impacts to agricultural and forestry resources, mineral resources, population and housing, or recreation.

Potential impacts related to air quality, biological resources, greenhouse gas emissions, hazards and hazardous materials, land use and planning, noise, and public services have been determined to be less than significant. Potential impacts relating to aesthetics, cultural resources, geology and soils, hydrology and water quality, transportation and traffic, and utilities and service systems have been determined to be less than significant with the identified Mitigation Measures.

A Mitigated Negative Declaration is recommended and is subject to approval by the decision-making body. The Initial Study is available for review at 2220 Tulare Street, Suite A, Street Level, located on the southeast corner of Tulare and "M" Street, Fresno, California.

DC:

G:\4360Devs&Pin\PROJSEC\PROJDOCS\CUP\3400-3499\3478\IS-CEQA\CUP3478 IS wu.docx

Mitigation Monitoring and Reporting Program
Initial Study Application No. 6888 / Classified Conditional Use Permit Application No. 3478
(Including Conditions of Approval and Project Notes)

Mitigation Measures					
Mitigation Measure No.*	Impact	Mitigation Measure Language	Implementation Responsibility	Monitoring Responsibility	Time Span
*1.	Aesthetic	All lighting shall be hooded and directed as to not shine toward adjacent properties and public streets.	Applicant	Applicant/Fresno County Department of Public Works and Planning (PW&P)	Ongoing
*2.	Cultural Resources	In the event that cultural resources are unearthed during ground-disturbing activity, all work shall be halted in the area of the find, and an Archeologist shall be called to evaluate the findings and make any necessary mitigation recommendations. If human remains are unearthed during ground-disturbing activity, no further disturbance is to occur until the Fresno County Coroner has made the necessary findings as to origin and disposition. If such remains are determined to be Native American, the Coroner must notify the Native American Commission within 24 hours.	Applicant	Applicant	Ongoing
*3.	Geology and Soils	Construct an 8-inch sanitary sewer main (including sewer house branches to adjacent properties) in N. Blythe Avenue from the existing 15-inch sewer main in W. McKinley Avenue north across the project frontage.	Applicant	Applicant/City of Fresno	Ongoing
*4.	Geology and Soils	Construct a 15-inch sanitary sewer main (including sewer house branches to adjacent properties) in W. McKinley Avenue from the existing 15-inch sewer main at the intersection of W. McKinley and N. Blythe Avenue east across the project frontage.	Applicant	Applicant/City of Fresno	Ongoing
*5.	Geology and Soils	Any existing septic system located on the subject parcel shall be properly destroyed under permit and inspection by the Fresno County Department of Public Works and Planning prior to occupancy being granted for the proposed religious facility.	Applicant	Applicant/PW&P	Ongoing
*6.	Geology and Soils	Engineered improvement plans prepared by a Registered Civil Engineer shall be submitted for City of Fresno Department of Public Utilities review and approval for proposed additions to the City sewer system.	Applicant	Applicant/City of Fresno	Ongoing
*7.	Geology	All public sanitary sewer facilities shall be constructed in	Applicant	Applicant/City of	Ongoing

	and Soils	accordance with City of Fresno Standards, Specifications, and Policies.		Fresno	
*8.	Geology and Soils	Pay all applicable City of Fresno Sewer Connection Fees per the Fresno Municipal Code and the City of Fresno Master Fee Schedule.	Applicant	Applicant/City of Fresno	Ongoing
*9.	Hydrology and Water Quality	The existing single-family residence shall be connected to the community water system operated by the City of Fresno prior to occupancy being granted for the proposed religious facility.	Applicant	Applicant/City of Fresno	Ongoing
*10.	Hydrology and Water Quality	The Applicant shall provide the City of Fresno Department of Public Utilities with a detailed water usage analysis identifying water fixture, landscape, and laundry efficiencies to document water conservation design characteristics, subject to approval by the Director of the City of Fresno Department of Public Utilities.	Applicant	Applicant/City of Fresno	Ongoing
*11.	Hydrology and Water Quality	Installation of water service(s) and meter box(es) shall be required.	Applicant	Applicant/City of Fresno	Ongoing
*12.	Hydrology and Water Quality	Pay all applicable City of Fresno Water Connection Fees per the Fresno Municipal Code and the City of Fresno Master Fee Schedule.	Applicant	Applicant/City of Fresno	Ongoing
*13.	Hydrology and Water Quality	Seal and abandon any existing on-site water well in accordance with City of Fresno Standards and State of California Well Standards Bulletin 74-90, or current revisions issued by the California Department of Water Resources.	Applicant	Applicant/City of Fresno	Ongoing
*14.	Hydrology and Water Quality	Outdoor storage areas shall be constructed and maintained in such a manner that material that may generate contaminants will be prevented from contact with rainfall and runoff, thereby preventing the conveyance of contaminants in runoff into the storm drain system.	Applicant	Applicant/Fresno Metropolitan Flood Control District (FMFCD)	Ongoing
*15.	Trans. / Traffic	All parking and circulation areas shall be surfaced with asphalt concrete (AC) paving prior to occupancy being granted for the proposed religious facility.	Applicant	Applicant/PW&P	Ongoing
Conditions of Approval					
1.	Development of the property shall be in accordance with the Site Plans, Floor Plans, Elevations, and Operational Statement approved by the Planning Commission.				

2.	Prior to occupancy, a Site Plan Review shall be submitted to and approved by the Department of Public Works and Planning in accordance with Section 874 of the Fresno County Zoning Ordinance. Conditions of the Site Plan Review may include: design of parking and circulation areas, access, on-site grading and drainage, fire protection, landscaping, signage, lighting and right-of-way dedication.
----	--

*MITIGATION MEASURE – Measure specifically applied to the project to mitigate potential adverse environmental effects identified in the environmental document. Conditions of Approval reference recommended Conditions for the project.

Notes	
The following Notes reference mandatory requirements of Fresno County or other Agencies and are provided as information to the project Applicant.	
1.	Plans related to construction and development of the project prepared by a licensed design professional shall be submitted to the Development Services Division of the Fresno County Department of Public Works and Planning for review and approval in order to acquire building and installation permits, and necessary inspections.
2.	20-foot by 20-foot corner cutoffs shall be maintained for sight distance purposes at any driveway accessing McKinley Avenue or Blythe Avenue.
3.	An Encroachment Permit shall be required from the Road Maintenance and Operations Division for any work performed within the County right-of-way.
4.	Due to the subject parcel being located within Fresno Metropolitan Flood Control District (FMFCD) Drainage Area AN, project development will require payment of a \$13,918.00 Drainage Fee to FMFCD.
5.	If construction associated with this proposal disturbs more than one acre, compliance with the National Pollutant Discharge Elimination System (NPDES) General Permit for Discharges of Storm Water Associated with Construction Activity will be required. Should compliance with the NPDES General Permit for Discharges of Storm Water Associated with Construction Activity be required, before construction begins, the Applicant must submit to the State Water Resources Control Board a Notice of Intent to comply with said permit, a Storm Water Pollution Prevention Plan (SWPPP), a Site Plan, and appropriate fees. The SWPPP must include descriptions of measures taken to prevent or eliminate unauthorized non-storm water discharges, and best management practices (BMP) implemented to prevent pollutants from discharging with storm water into waters of the United States.
6.	A Grading Permit or Voucher shall be required for any grading activity associated with this proposal.



EXHIBIT 3

County of Fresno

DEPARTMENT OF PUBLIC WORKS AND PLANNING
BERNARD JIMENEZ, INTERIM DIRECTOR

EVALUATION OF ENVIRONMENTAL IMPACTS

APPLICANT: Sy Nguyen Le

APPLICATION NOS.: Initial Study Application No. 6888 and Classified Conditional Use Permit Application No. 3478

DESCRIPTION: Allow an approximately 3,939 square-foot religious facility with related improvements on a 2.50-acre parcel in the R-R (nb) (Rural Residential, two-acre minimum parcel size, Neighborhood Beautification Overlay) Zone District.

LOCATION: The subject parcel is located on the northeast corner of McKinley Avenue and Blythe Avenue, approximately 40 feet east of the nearest city limits of the City of Fresno (4354 W. McKinley Avenue) (Sup. Dist.: 1) (APN: 312-082-14).

I. AESTHETICS

- A. Would the project have a substantial adverse effect on a scenic vista; or
- B. Would the project substantially damage scenic resources, including, but not limited to, trees, rock outcroppings, and historic buildings within a State scenic highway; or
- C. Would the project substantially degrade the existing visual character or quality of the site and its surroundings?

FINDING: LESS THAN SIGNIFICANT IMPACT:

This proposal entails the utilization of an existing 2,613 square-foot single-family residence located on a 2.50-acre parcel in the R-R(nb) (Rural Residential, two-acre minimum parcel size, Neighborhood Beautification Overlay) Zone District as a religious facility. No exterior modification or expansion of the existing single-family residence structure is proposed with this project. The proposed religious facility will host services for approximately 12 followers on Saturday and Sunday mornings, year round. These services will be conducted within the interior of the existing single-family residence, and no outdoor sound amplification is proposed with this project. Additionally, approximately 40 people will visit the site during the following annual special events:

- *Buddha's Birthday, one Sunday in May from 9am – 2pm*
- *Annual Parents Gratitude Day, one Sunday usually in August from 9am – 2pm*
- *Chinese/Vietnamese Lunar New Year, one day usually in February from early morning to late afternoon*

DEVELOPMENT SERVICES DIVISION
2220 Tulare Street, Sixth Floor / Fresno, California 93721 / Phone (559) 600-4497 / 600-4022 / 600-4540 / FAX 600-4200
The County of Fresno is an Equal Employment Opportunity Employer

The subject parcel currently has access from McKinley Avenue via two existing 13-foot wide paved driveways. The proposed religious facility will utilize these existing driveways in conjunction with a proposed paved parking lot with 32 paved parking spaces and a proposed 18-foot wide paved driveway on Blythe Avenue that will be utilized for exit only.

The subject parcel is located within the sphere-of-influence of the City of Fresno, is easterly adjacent to the city limits of the City of Fresno, and is located in a predominately urbanized area marked by residential subdivisions. Additionally, an elementary school (Central Unified McKinley Elementary School) is westerly adjacent to the subject parcel, a high school (Central Unified High School East Campus) is located approximately one and a half miles to the northwest, and State Route (SR) 99 is located approximately two miles to the east. Considering the close proximity of another institutional use (i.e. Central Unified McKinley Elementary School) in conjunction with the fact that the proposed conversion of the existing single-family residence into a religious facility does not entail any exterior modification or expansion of said structure, staff does not believe this proposal will degrade the existing visual character or quality of the site and its surroundings. Further, the subject parcel is not located along a designated Scenic Highway, and no scenic vistas or scenic resources were identified in the analysis.

- D. Would the project create a new source of substantial light or glare which would adversely affect day or nighttime views in the area?

FINDING: LESS THAN SIGNIFICANT IMPACT WITH MITIGATION INCORPORATED:

This proposal does not include a request to utilize outdoor lighting. However, in order to ensure that the proposed religious facility will not generate new sources of light and glare in the area, a Mitigation Measure will be included to require any outdoor lighting utilized at the proposed religious facility to be hooded and directed as to not shine towards adjacent properties and public streets.

* **Mitigation Measure**

- 1. All outdoor lighting shall be hooded and directed as to not shine towards adjacent properties and public streets.*

II. AGRICULTURAL AND FORESTRY RESOURCES

- A. Would the project convert prime or unique farmlands or farmland of state-wide importance to non-agricultural use; or
- B. Would the project conflict with existing agricultural zoning or Williamson Act Contracts; or
- C. Would the project conflict with existing zoning for or cause rezoning of forest land, timberland, or timberland zoned Timberland Production; or

- D. Would the project result in the loss of forest land or conversion of forest land to non-forest use; or
- E. Would the project involve other changes in the existing environment which, due to their location or nature, could result in conversion of Farmland to non-agricultural uses or conversion of forest land to non-forest use?

FINDING: NO IMPACT:

The subject parcel is located in a predominately urbanized area marked by residential subdivisions. Further, the subject parcel is not located on forest land, is classified as Rural Residential Land on the Fresno County Important Farmland Map (2012), and is not enrolled under a Williamson Act contract. As such, staff believes that this proposal will result in no impact to agricultural or forestry resources.

III. AIR QUALITY

- A. Would the project conflict with or obstruct implementation of the applicable Air Quality Plan; or
- B. Would the project isolate any air quality standard or contribute to an existing or projected air quality violation; or
- C. Would the project result in a cumulatively considerable net increase of any criteria pollutant for which the project region is non-attainment under a Federal or State ambient air quality standard; or
- D. Would the project expose sensitive receptors to substantial pollutant concentrations; or
- E. Would the project create objectionable odors affecting a substantial number of people?

FINDING: LESS THAN SIGNIFICANT IMPACT:

This proposal was reviewed by the San Joaquin Valley Unified Air Pollution Control District (Air District), which did not express any concerns related to the project. However, staff notes that this proposal may be subject to the following Air District Rules: Regulation VIII (Fugitive Dust Rules), Rule 4102 (Nuisance), Rule 4601 (Architectural Coatings), Rule 4641 (Cutback, Slow Cure, and Emulsified Asphalt, Paving and Maintenance Operations), and Rule 4002 (National Emission Standards for Hazardous Air Pollutants). Compliance with Air District Rules will reduce air quality impacts of the subject proposal to less than significant.

IV. BIOLOGICAL RESOURCES

- A. Would the project have a substantial adverse effect, either directly or through habitat modifications, on any candidate, sensitive, or special-status species; or

- B. Would the project have a substantial adverse effect on any riparian habitat or other sensitive natural community identified in local or regional plans, policies, regulations, or by the California Department of Fish and Wildlife (CDFW) or U.S. Fish and Wildlife Service (USFWS); or
- C. Would the project have a substantial adverse effect on federally-protected wetlands as defined by Section 404 of the Clean Water Act through direct removal, filling, hydrological interruption or other means; or
- D. Would the project interfere substantially with the movement of any native resident or migratory fish or wildlife species or with established native resident or migratory wildlife corridors, or impede the use of native wildlife nursery sites; or
- E. Would the project conflict with any local policies or ordinances protecting biological resources, such as a tree preservation policy or ordinance; or
- F. Would the project Conflict with the provisions of an adopted Habitat Conservation Plan, Natural Community Conservation Plan, or other approved local regional, or state habitat conservation plan?

FINDING: LESS THAN SIGNIFICANT IMPACT:

The subject parcel is located in a predominately urbanized area marked by residential subdivisions, and has been previously disturbed as said property has been improved with a single-family residence. Additionally, neighboring properties have also been improved with single-family residences and/or school-related improvements. As such, neighboring properties have also been previously disturbed. This proposal was referred to the U.S. Fish and Wildlife Service (USFWS), which did not express any concerns related to the project. This proposal was also referred to the California Department of Fish and Wildlife (CDFW), which also did not identify any concerns related to the project. Therefore, no impacts were identified in regard to: 1) any candidate, sensitive, or special-status species; 2) any riparian habitat or other sensitive natural community identified in local or regional plans, policies, regulations, or by the CDFW or USFWS; 3) Federally protected wetlands as defined by Section 404 of the Clean Water Act; and 4) the movement of any native resident or migratory fish or wildlife species or with established native resident or migratory wildlife corridors, or impede the use of native wildlife nursery sites. This proposal will not conflict with any local policies or ordinances protecting biological resources or any provisions of an adopted Habitat Conservation Plan, Natural Community Conservation Plan, or other approved local, regional, or state Habitat Conservation Plan.

V. CULTURAL RESOURCES

- A. Would the project cause a substantial adverse change in the significance of a historical resource as defined in Section 15064.5; or
- B. Would the project cause of substantial adverse change in the significance of an archeological resource pursuant to Section 15064.5; or

- C. Would the project directly or indirectly destroy a unique paleontological resource or site or unique geologic feature; or
- D. Would the project disturb any human remains, including those interred outside of formal cemeteries?

FINDING: LESS THAN SIGNIFICANT IMPACT WITH MITIGATION INCORPORATED:

The subject parcel is not located within proximity of any area designated to be highly or moderately sensitive for archeological resources. However, in the event that cultural resources are unearthed during ground disturbing activity, all work shall be halted in the area of the find, and an Archeologist shall be utilized to evaluate the findings and make any necessary mitigation recommendations. If human remains are unearthed during ground disturbing activity, no further disturbance is to occur until the Fresno County Coroner has made the necessary findings as to origin and disposition of the remains. If such remains are determined to be Native American, the Coroner must notify the Native American Commission within 24 hours. A Mitigation Measure reflecting this requirement has been incorporated into the project. The Mitigation Measure will reduce potential impacts to cultural resources to less than significant.

* **Mitigation Measure**

1. *In the event that cultural resources are unearthed during ground disturbing activity, all work shall be halted in the area of the find, and an Archeologist shall be utilized to evaluate the findings and make any necessary mitigation recommendations. If human remains are unearthed during ground disturbing activity, no further disturbance is to occur until the Fresno County Coroner has made the necessary findings as to origin and disposition. If such remains are determined to be Native American, the Coroner must notify the Native American Commission within 24 hours.*

VI. GEOLOGY AND SOILS

- A. Would the project expose people or structures to potential substantial adverse effects, including risk of loss, injury or death involving:
 1. Rupture of a known earthquake; or
 2. Strong seismic ground shaking; or
 3. Seismic-related ground failure, including liquefaction; or
 4. Landslides?

FINDING: NO IMPACT:

The area in which the subject parcel is located is designated as Seismic Design Category C in the California Geological Survey. No agency expressed concerns related to ground shaking, ground failure, liquefaction or landslides. Development of the project will be subject to the Seismic Design Category C Standards.

- B. Would the project result in substantial erosion or loss of topsoil?

FINDING: LESS THAN SIGNIFICANT IMPACT:

The subject parcel has predominately flat topography and while changes in topography and erosion may result from grading activities associated with this proposal, it is not likely. According to the Development Engineering Section of the Fresno County Department of Public Works and Planning, the Applicant must obtain a Grading Permit or Grading Voucher for any grading associated with this proposal.

- C. Would the project result in on-site or off-site landslide, lateral spreading, subsidence, liquefaction or collapse; or

- D. Would the project be located on expansive soils, creating substantial risks to life or property?

FINDING: NO IMPACT:

The subject parcel is not located within an area of known risk of landslides, lateral spreading, subsidence, liquefaction, collapse, or within an area of known expansive soils.

- E. Would the project have soils incapable of adequately supporting the use of septic tanks or alternative disposal systems where sewers are not available for wastewater disposal?

FINDING: LESS THAN SIGNIFICANT IMPACT WITH MITIGATION INCORPORATED:

According to the Environmental Health Division of the Fresno County Department of Public Health, County records indicate that the septic system serving the existing single-family residence to be converted into the proposed religious facility is not adequate to serve the proposed use. Additionally, County records also indicate that the septic system serving the existing single-family residence is located on the south side of said structure, partially within the ultimate Right-of-Way of McKinley Avenue. However, the Site Plan provided for this proposal shows the septic system serving the existing single-family residence being located on the east side of said structure. This is due to a previous property owner having abandoned the septic system identified on County records, and constructing the septic system identified on the Site Plan provided for this proposal. It is noted that no permits were obtained for either the abandonment of the septic system identified on County records or the construction of the septic system identified on the Site Plan provided for this proposal.

According to the City of Fresno Department of Public Utilities, connection of the proposed religious facility to the community sewer system operated by the City of Fresno is required per Fresno Municipal Code (FMC) Section 6-303. The nearest City of Fresno sewer main in relation to the subject parcel terminates at the intersection of Blythe Avenue and McKinley Avenue. Connection of the proposed religious facility to the community sewer system operated by the City of Fresno shall be completed prior to occupancy being granted for the proposed use. Further, connection of the proposed religious facility to the community sewer system operated by the City of Fresno has the following requirements that the Applicant must abide by, which are included as Mitigation Measures to reduce potential impacts to soils to less than significant:

*** Mitigation Measures**

- 1. Construct an 8-inch sanitary sewer main (including sewer house branches to adjacent properties) in N. Blythe Avenue from the existing 15-inch sewer main in W. McKinley Avenue north across the project frontage.*
- 2. Construct a 15-inch sanitary sewer main (including sewer house branches to adjacent properties) in W. McKinley Avenue from the existing 15-inch sewer main at the intersection of W. McKinley and N. Blythe Avenue east across the project frontage.*
- 3. Any existing septic system located on the subject parcel shall be properly destroyed under permit and inspection by the Fresno County Department of Public Works and Planning prior to occupancy being granted for the proposed religious facility.*
- 4. Engineered improvement plans prepared by a Registered Civil Engineer shall be submitted for City of Fresno Department of Public Utilities review and approval for proposed additions to the City sewer system.*
- 5. All public sanitary sewer facilities shall be constructed in accordance with City of Fresno Standards, Specifications, and Policies.*
- 6. Pay all applicable City of Fresno Sewer Connection Fees per the Fresno Municipal Code and the City of Fresno Master Fee Schedule.*

VII. GREENHOUSE GAS EMISSIONS

- A.** Would the project generate greenhouse gas emissions, either directly or indirectly, that may have a significant impact on the environment; or
- B.** Would the project conflict with any applicable plan, policy or regulation adopted for the purpose of reducing the emissions of greenhouse gases?

FINDING: LESS THAN SIGNIFICANT IMPACT:

The San Joaquin Valley Unified Air Pollution Control District (Air District) reviewed this proposal and expressed no concerns related to greenhouse gas emissions. Further, compliance with Air District Rules and Regulations discussed in Section III (Air Quality) of this analysis will reduce air quality impacts from the subject proposal to less than significant.

VIII. HAZARDS AND HAZARDOUS MATERIALS

- A. Would the project create a significant public hazard through routine transport, use or disposal of hazardous materials; or
- B. Would the project create a significant public hazard involving accidental release of hazardous materials into the environment; or
- C. Would the project create hazardous emissions or utilize hazardous materials, substances or waste within one quarter-mile of a school?

FINDING: LESS THAN SIGNIFICANT IMPACT:

With regard to the conversion of the existing single-family residence to a religious facility, the Fresno County Department of Public Health, Environmental Health Division has consistently provided comments for such conversion proposals which state that any active rodent or insect infestation must be abated prior to remodeling the structure in order to prevent the spread of vectors to adjacent properties. Additionally, in the process of remodeling the existing single-family residence, the contractor may encounter asbestos containing construction materials and materials coated with lead based paints. Should such materials be encountered, the San Joaquin Valley Unified Air Pollution Control District (Air District) must be contacted for more information. Further, if lead-based paint is suspected to have been used in the existing residence structure, the contractor must contact the following agencies for current regulations and requirements prior to demolition and/or remodel work: a) California Department of Public Health, Childhood Lead Poisoning Prevention Branch; b) United States Environmental Protection Agency, Region 9; c) California Industrial Relations Department, Division of Occupational Safety and Health, Consultation Service. Additionally, any construction materials deemed hazardous as identified in the remodel process shall be characterized and disposed of in accordance with current federal, state, and local requirements.

It is noted that an elementary school (Central Unified McKinley Elementary School) is westerly adjacent to the subject parcel.

- D. Would the project be located on a hazardous materials site?

FINDING: NO IMPACT:

No hazardous materials sites are located within the boundaries of the subject parcel.

- E. Would a project located within an airport land use plan or, absent such a plan, within two miles of a public airport or public use airport, result in a safety hazard for people residing or working in the project area; or
- F. Would a project located within the vicinity of a private airstrip result in a safety hazard for people residing or working in the project area?

FINDING: NO IMPACT:

The subject parcel is not located within an Airport Land Use Plan or in the vicinity of a public or private use airport.

- G. Would the project impair implementation of or physically interfere with an adopted Emergency Response Plan or Emergency Evacuation Plan?

FINDING: NO IMPACT:

This proposal will not impair the implementation of, or physically interfere with an adopted Emergency Response Plan.

- H. Would the project expose people or structures to a significant risk of loss, injury or death involving wildland fires, including where wildlands are adjacent to urbanized areas or where residences are intermixed with wildlands?

FINDING: NO IMPACT:

The subject parcel is not located within a wildland area.

IX. HYDROLOGY AND WATER QUALITY

- A. Would the project violate any water quality standards or waste discharge requirements or otherwise degrade water quality?

FINDING: LESS THAN SIGNIFICANT IMPACT:

According to the Fresno Metropolitan Flood Control District, if construction associated with this proposal disturbs more than one acre, compliance with the National Pollutant Discharge Elimination System (NPDES) General Permit for Discharges of Storm Water Associated with Construction Activity will be required. Should compliance with the NPDES General Permit for Discharges of Storm Water Associated with Construction Activity be required, before construction begins, the Applicant must submit to the State Water Resources Control Board a Notice of Intent to comply with said permit, a Storm Water Pollution Prevention Plan (SWPPP), a Site Plan, and appropriate fees. The SWPPP must include descriptions of measures taken to prevent or eliminate unauthorized non-storm water discharges, and best management practices (BMP) implemented to prevent pollutants from discharging with storm water into waters of the United States.

- B. Would the project substantially deplete groundwater supplies or interfere substantially with groundwater recharge so that there would be a net deficit in aquifer volume or a lowering of the local groundwater table?

FINDING: LESS THAN SIGNIFICANT IMPACT WITH MITIGATION INCORPORATED:

The existing single-family residence to be converted into the proposed religious facility currently utilizes an existing water well located on the subject parcel. According to the City of Fresno Department of Public Utilities, the nearest City of Fresno water main available to serve the proposed use is located within Blythe Avenue, westerly adjacent to the subject parcel. Considering that a community water system is available to serve the proposed use, the existing single-family residence shall be connected to the community water system operated by the City of Fresno prior to occupancy being granted for the proposed use. Further, connection of the proposed religious facility to the community water system operated by the City of Fresno has the following requirements that the Applicant must abide by, which are included as Mitigation Measures to reduce potential impacts to groundwater to less than significant:

* **Mitigation Measures**

1. *The existing single-family residence shall be connected to the community water system operated by the City of Fresno prior to occupancy being granted for the proposed religious facility.*
2. *The Applicant shall provide the City of Fresno Department of Public Utilities with a detailed water usage analysis identifying water fixture, landscape, and laundry efficiencies to document water conservation design characteristics, subject to approval by the Director of the City of Fresno Department of Public Utilities.*
3. *Installation of water service(s) and meter box(es) shall be required.*
4. *Pay all applicable City of Fresno Water Connection Fees per the Fresno Municipal Code and the City of Fresno Master Fee Schedule.*
5. *Seal and abandon any existing onsite water well in accordance with City of Fresno Standards and State of California Well Standards Bulletin 74-90, or current revisions issued by the California Department of Water Resources.*

This proposal was reviewed by the Water/Geology/Natural Resources Section of the Fresno County Department of Public Works and Planning, which expressed no concerns with the project as the subject parcel is not located in a designated water-short area, and the proposed religious facility will be required to utilize a community water system operated by the City of Fresno.

- C. Would the project substantially alter existing drainage patterns, including alteration of the course of a stream or river, in a manner which would result in substantial erosion or siltation on or off site; or

- D. Would the project substantially alter existing drainage patterns, including alteration of the course of a stream or river, in a manner which would result in flooding on or off site?

FINDING: NO IMPACT:

No streams or rivers are located near the subject parcel.

- E. Would the project create or contribute run-off which would exceed the capacity of existing or planned storm water drainage systems or provide substantial additional sources of polluted run-off?

FINDING: LESS THAN SIGNIFICANT IMPACT WITH MITIGATION INCORPORATED:

Permanent improvements associated with the development of the proposed religious facility will not cause significant changes in absorption rates, drainage patterns or the rate and amount of surface run-off, with adherence to the Grading and Drainage Sections of the Fresno County Ordinance Code.

According to the Fresno Metropolitan Flood Control District (FMFCD), due to the subject parcel being located within FMFCD Drainage Area AN, project development will require payment of a \$13,918.00 Drainage Fee. Additionally, outdoor storage areas shall be constructed and maintained in such a manner that material that may generate contaminants will be prevented from contact with rainfall and runoff, thereby preventing the conveyance of contaminants in runoff into the storm drain system. This requirement will be included as a Mitigation Measure to reduce potential impacts to water quality to less than significant.

* **Mitigation Measure**

- 1. Outdoor storage areas shall be constructed and maintained in such a manner that material that may generate contaminants will be prevented from contact with rainfall and runoff, thereby preventing the conveyance of contaminants in runoff into the storm drain system.*

- F. Would the project otherwise substantially degrade water quality?

FINDING: NO IMPACT:

No additional water quality impacts were identified in the project analysis.

- G. Would the project place housing within a 100-year floodplain; or

- H. Would the project place structures within a 100-year flood hazard area that would impede or redirect flood flows?

FINDING: NO IMPACT:

According to FEMA FIRM Panel 1565H, the project site is not subject to flooding from the 100-year storm.

- I. Would the project expose persons or structures to levee or dam failure; or
- J. Would the project cause inundation by seiche, tsunami or mudflow?

FINDING: NO IMPACT:

The subject parcel is not prone to seiche, tsunami or mudflow, nor is the subject parcel exposed to potential levee or dam failure.

X. LAND USE AND PLANNING

- A. Will the project physically divide an established community?

FINDING: NO IMPACT:

This proposal will not physically divide a community. The subject parcel is located approximately 40 feet east of the nearest city limits of the City of Fresno.

- B. Will the project conflict with any Land Use Plan, policy or regulation of an agency with jurisdiction over the project?

FINDING: LESS THAN SIGNIFICANT IMPACT:

The subject parcel is designated Rural Residential in the County-adopted Fresno High-Roeding Community Plan and is zoned R-R(nb) (Rural Residential, two-acre minimum parcel size, Neighborhood Beautification Overlay). The Rural Residential General Plan designation accommodates religious facilities provided that the facilities are necessary to serve the needs of the rural residential population and occur in a manner compatible with the surrounding rural area. In this case, the proposal entails utilization of an existing 2,613 square-foot single-family residence as a religious facility on a 2.50-acre parcel located in a predominately urbanized area within the City of Fresno sphere-of-influence, approximately 40 feet east of the nearest city limits of the City of Fresno. No exterior modification or expansion of the existing single-family residence structure is proposed with this project. The proposed religious facility will host services for approximately 12 followers on Saturday and Sunday mornings, year round, and approximately 40 people will visit the site during three annual special events. Considering the relatively limited scope of this proposal, staff believes the proposed use is consistent with the General Plan.

- C. Will the project conflict with any applicable Habitat Conservation Plan or Natural Community Conservation Plan?

FINDING: NO IMPACT:

This proposal will not conflict with any Land Use Plan or habitat or Natural Community Conservation Plan. No such Plans were identified in the project analysis.

XI. MINERAL RESOURCES

- A. Would the project result in the loss of availability of a known mineral resource; or
- B. Would the project result in the loss of availability of a locally-important mineral resource recovery site designated on a General Plan?

FINDING: NO IMPACT:

No mineral resource impacts were identified in the project analysis. The subject parcel is not located in an identified mineral resource area identified in Policy OS-C.2 of the General Plan.

XII. NOISE

- A. Would the project result in exposure of people to severe noise levels; or
- B. Would the project result in exposure of people to or generate excessive ground-borne vibration or ground-borne noise levels; or
- C. Would the project cause a substantial permanent increase in ambient noise levels in the project vicinity; or
- D. Would the project result in a substantial temporary or periodic increase in ambient noise levels?

FINDING: LESS THAN SIGNIFICANT IMPACT:

The proposed religious facility will host services for approximately 12 followers on Saturday and Sunday mornings, year round. These services will be conducted within the interior of the existing single-family residence to be utilized as the proposed religious facility, and no outdoor sound amplification is proposed with this project. Additionally, approximately 40 people will visit the site during three annual special events. The proposed use must comply with the Noise Element of the Fresno County General Plan and the Fresno County Noise Ordinance, thereby minimizing noise impacts to less than significant.

- E. Would the project expose people to excessive noise levels associated with a location near an airport or a private airstrip; or
- F. For a project within the vicinity of a private airstrip, would the project expose people residing or working in the project area to excessive noise levels?

FINDING: NO IMPACT:

The subject parcel is not located in the vicinity of a public airport or private airstrip, and is not impacted by airport noise.

XIII. POPULATION AND HOUSING

- A. Would the project induce substantial population growth either directly or indirectly; or
- B. Would the project displace substantial numbers of existing housing; or
- C. Would the project displace substantial numbers of people, necessitating the construction of housing elsewhere?

FINDING: NO IMPACT:

This proposal will not result in an increase of housing, nor will it otherwise induce population growth.

XIV. PUBLIC SERVICES

- A. Would the project result in substantial adverse physical impacts associated with the provision of new or physically-altered public facilities in the following areas:
 - 1. Fire protection?

FINDING: LESS THAN SIGNIFICANT IMPACT:

This proposal was reviewed by the North Central Fire Protection District for requirements related to water supply, fire hydrants, and fire apparatus access. No concerns were expressed by said agency. Review of this proposal by the North Central Fire Protection District for compliance with fire and life safety requirements for the interior of the existing single-family residence to be utilized as the proposed religious facility will be conducted by said agency. Any development associated with this proposal must comply with the California Code of Regulations Title 24 – Fire Code.

- 2. Police protection; or
- 3. Schools; or
- 4. Parks; or
- 5. Other public facilities?

FINDING: NO IMPACT:

No impacts on the provision of other services were identified in the project analysis.

XV. RECREATION

- A. Would the project increase the use of existing neighborhood and regional parks; or
- B. Would the project require the construction of or expansion of recreational facilities?

FINDING: NO IMPACT:

No such impacts were identified in the project analysis.

XVI. TRANSPORTATION/TRAFFIC

- A. Would the project conflict with any applicable plan, ordinance or policy establishing measures of effectiveness for the performance of the circulation system, taking into account all modes of transportation; or
- B. Would the project conflict with an applicable congestion management program, including, but not limited to, level of service standards and travel demands measures?

FINDING: LESS THAN SIGNIFICANT IMPACT:

The proposed religious facility will host services for approximately 12 followers on Saturday and Sunday mornings, year round, and approximately 40 people will visit the site during three annual special events, which include Buddha’s Birthday (one Sunday in May from 9am – 2pm), Annual Parents Gratitude Day (one Sunday usually in August from 9am – 2pm), and Chinese/Vietnamese Lunar New Year (one day usually in February from early morning to late afternoon). As such, the proposed use may generate approximately 24 one-way visitor trips (12 round trips) for religious services on Saturdays and Sundays, year round, and approximately 80 one-way visitor trips (40 round trips) per each of the three annual special events.

The subject parcel currently has access from McKinley Avenue via two existing 13-foot wide paved driveways. The proposed religious facility will utilize these existing driveways in conjunction with a proposed paved parking lot with 32 paved parking spaces and a proposed 18-foot wide paved driveway on Blythe Avenue that will be utilized for exit only.

McKinley Avenue is a County-maintained road with an existing 40-foot right-of-way north of the section line which fronts the subject parcel. Due to McKinley Avenue being classified as an Arterial in the Transportation and Circulation Element of the County General Plan, McKinley Avenue has an ultimate right-of-way of 106 feet at the subject parcel, with 53 feet north and 53 feet south of the section line. Additionally, Blythe Avenue is jointly maintained by the County and City of Fresno, and the portion of Blythe Avenue that fronts the subject parcel has a variable existing right-of-way which ranges from 20 to 30 feet east of the center line. Due to Blythe Avenue being classified as an Arterial in the Transportation and Circulation Element of the County General Plan, Blythe Avenue has an ultimate right-of-way of 106 feet at the subject parcel, with 53 feet east and 53 feet west of the center line.

This proposal was reviewed by the Road Maintenance and Operations Division of the Fresno County Department of Public Works and Planning, which commented that an irrevocable offer of 13 feet of additional right-of-way dedication is needed from the southern side of the subject parcel which abuts McKinley Avenue in order to comply with the Arterial right-of-way standard identified in the Transportation and Circulation Element of the County General Plan. Additionally, the Road Maintenance and Operations Division also commented that irrevocable offers of 33 feet and 23 feet of additional right-of-way dedication are needed from the western side of the subject parcel which abuts Blythe Avenue in order to comply with the Arterial right-of-way standard identified in the Transportation and Circulation Element of the County General Plan.

This proposal was also reviewed by the Design Division of the Fresno County Department of Public Works and Planning, which commented that the amount of traffic to be generated by the proposed use is not significant and will not impact County roadways. However, said agency also commented that the irrevocable offers of additional right-of-way dedication for McKinley Avenue and Blythe Avenue as identified by the Road Maintenance and Operations Division are necessary to ensure compliance with the Transportation and Circulation Element of the County General Plan.

This proposal was also reviewed by the City of Fresno Public Works Department, which commented that the intersection of McKinley Avenue and Blythe Avenue is planned to someday have full improvements, including traffic signals. As such, the irrevocable offers of additional right-of-way dedication for McKinley Avenue and Blythe Avenue as identified by the Road Maintenance and Operations Division are necessary to ensure orderly development of the intersection. Further, the City depends on development projects as a means to acquire right-of-way needed for road improvement projects.

Staff acknowledges that the irrevocable offers of additional right-of-way dedication for McKinley Avenue and Blythe Avenue as identified by the Road Maintenance and Operations Division would help to bring the roadways into further compliance with the Arterial right-of-way standard identified in the Transportation and Circulation Element of the County General Plan. Staff also acknowledges that the City may experience an economic hardship in the future if the intersection is improved, should the irrevocable offers of additional right-of-way dedication for McKinley Avenue and Blythe Avenue not be required. However, no substantial traffic hazard issues were identified by any agency reviewing this proposal. Further, the amount of traffic to be generated by the proposed use has been determined to be less than significant and will not impact roadways in the area. As such, no irrevocable offers of additional right-of-way dedication are required for this project.

C. Would the project result in a change in air traffic patterns?

FINDING: NO IMPACT:

This proposal will not result in a change in air traffic patterns. No such impacts were identified in the project analysis.

- D. Would the project substantially increase traffic hazards due to design features; or
- E. Would the project result in inadequate emergency access?

FINDING: LESS THAN SIGNIFICANT IMPACT WITH MITIGATION INCORPORATED:

According to the City of Fresno Public Works Department, the Applicant should be required to provide a concrete curb, gutter, and sidewalk along the McKinley Avenue frontage and Blythe Avenue frontage of the subject parcel, constructed in compliance with the City of Fresno Public Works Department Standard P-5 development criteria. However, no substantial traffic hazard or substantial emergency access issue was identified by the City of Fresno to require such improvements under CEQA. Further, the portions of McKinley Avenue and Blythe Avenue which are contiguous with the subject parcel do not have any existing curbs, gutters or sidewalks.

According to the Road Maintenance and Operations Division of the Fresno County Department of Public Works and Planning, the Applicant must obtain an Encroachment Permit from the Road Maintenance and Operations Division for all improvements within the County right-of-way. Further, all parking and circulation areas shall be surfaced with asphalt concrete (AC) paving. This requirement will be included as a Mitigation Measure to reduce potential impacts to transportation to less than significant.

* **Mitigation Measure**

1. *All parking and circulation areas shall be surfaced with asphalt concrete (AC) paving prior to occupancy being granted for the proposed religious facility.*

- F. Would the project conflict with adopted plans, policies or programs regarding public transit, bicycle or pedestrian facilities or otherwise decrease the performance or safety of such facilities?

FINDING: NO IMPACT:

This proposal will not conflict with any adopted alternative transportation plans. No such impacts were identified in the project analysis.

XVII. UTILITIES AND SERVICE SYSTEMS

- A. Would the project exceed wastewater treatment requirements; or
- B. Would the project require construction of or the expansion of new water or wastewater treatment facilities?

FINDING: LESS THAN SIGNIFICANT IMPACT WITH MITIGATION INCORPORATED:

See discussion in Section VI.E Geology and Soils.

- C. Would the project require or result in the construction or expansion of new storm water drainage facilities?

FINDING: LESS THAN SIGNIFICANT IMPACT WITH MITIGATION INCORPORATED:

See discussion in Section IX.E Hydrology and Water Quality.

- D. Would the project have sufficient water supplies available from existing entitlements and resources, or are new or expanded entitlements needed?

FINDING: LESS THAN SIGNIFICANT IMPACT WITH MITIGATION INCORPORATED:

See discussion in Section IX.B Hydrology and Water Quality.

- E. Would the project result in a determination of inadequate wastewater treatment capacity to serve project demand; or

FINDING: LESS THAN SIGNIFICANT IMPACT WITH MITIGATION INCORPORATED:

See discussion in Section VI.E Geology and Soils.

- F. Would the project be served by a landfill with sufficient permitted capacity; or

- G. Would the project comply with federal, state and local statutes and regulations related to solid waste?

FINDING: NO IMPACT:

No such impacts were identified in the project analysis.

XVIII. MANDATORY FINDINGS OF SIGNIFICANCE

- A. Does the project have the potential to degrade the quality of the environment, substantially reduce the habitat of a fish or wildlife species, cause a fish or wildlife population to drop below self-sustaining levels, threaten to eliminate a plant or animal community, reduce the number or restrict the range of a rare or endangered plant or animal, or eliminate important examples of the major periods of California prehistory or history?

FINDING: LESS THAN SIGNIFICANT IMPACT WITH MITIGATION INCORPORATED:

Development of the project may impact aesthetics. The included Mitigation Measure in Section I (Aesthetics) will minimize such impacts to less than significant. Pursuant to discussion in Section IV (Biological Resources), no such impacts on biological resources were identified in the project analysis. Development of the project may impact cultural resources. The included Mitigation Measure in Section V (Cultural Resources) will minimize such impacts to less than significant. Development of the project may impact geology and soils. The included Mitigation Measures in Section VI

(Geology and Soils) will minimize such impacts to less than significant. Development of the project may impact hydrology and water quality. The included Mitigation Measures in Section IX (Hydrology and Water Quality) will minimize such impacts to less than significant. Development of the project may impact transportation and traffic. The included Mitigation Measure in Section XVI (Transportation/Traffic) will minimize such impacts to less than significant.

- B. Does the project have impacts that are individually limited, but cumulatively considerable?

FINDING: NO IMPACT:

No cumulatively considerable impacts were identified in the project analysis.

- C. Does the project have environmental impacts which will cause substantial adverse effects on human beings, either directly or indirectly?

FINDING: NO IMPACT:

No substantial adverse impacts on human beings were identified in the project analysis.

CONCLUSION/SUMMARY

Based upon the Initial Study prepared for Classified Conditional Use Permit Application No. 3478, staff has concluded that the project will not have a significant effect on the environment. It has been determined that there would be no impacts to agricultural and forestry resources, mineral resources, population and housing, or recreation.

Potential impacts related to air quality, biological resources, greenhouse gas emissions, hazards and hazardous materials, land use and planning, noise, and public services have been determined to be less than significant. Potential impacts relating to aesthetics, cultural resources, geology and soils, hydrology and water quality, transportation and traffic, and utilities and service systems have been determined to be less than significant with the identified Mitigation Measures.

A Mitigated Negative Declaration is recommended and is subject to approval by the decision-making body. The Initial Study is available for review at 2220 Tulare Street, Suite A, Street Level, located on the southeast corner of Tulare and "M" Street, Fresno, California.

DC:

G:\4360Devs&Pin\PROJSEC\PROJDOCS\CUP\3400-3499\3478\IS-CEQA\NEW IS\CUP3478 IS wu REVISED.docx