



County of Fresno

DEPARTMENT OF PUBLIC WORKS AND PLANNING
STEVEN E. WHITE, DIRECTOR

Planning Commission Staff Report Consent Agenda Item No. 2 June 10, 2021

SUBJECT: Vesting Tentative Tract Map No. 5430 - Time Extension

Grant a one-year discretionary time extension to exercise Vesting Tentative Tract Map No. 5430, which authorizes the division of 179.57 acres into 561 residential lots in the R-1(c) (Single-Family Residential, 6,000 square-foot minimum parcel size, Conditional) and R-1-C(c) (Single-Family Residential, 9,000 square-foot minimum parcel size, Conditional) Zone Districts.

LOCATION: The subject property is located on the north side of Millerton Road between Winchell Cove Road and the Friant-Kern Canal, within the Millerton New Town Specific Plan area, approximately 1.8 miles east of the unincorporated community of Friant (SUP. DIST. 5) (APNs 300-021-27S, 300-032-12S, 300-340-01S, 300-340-03S, 300-340-30S, 300-032-66S).

OWNER: Assemi Group

APPLICANT: Jeffrey T. Roberts

STAFF CONTACT: Jeremy Shaw, Planner
(559) 600-4207

David Randall, Senior Planner
(559) 600-4052

RECOMMENDATION:

- Approve a one-year discretionary time extension for Vesting Tentative Tract Map No. 5430; and
- Direct the Secretary to prepare a Resolution documenting the Commission's action.

EXHIBITS:

1. Location Map
2. Existing Land Use Map
3. Existing Zoning Map
4. Tentative Tract Map 5430
5. Board Agenda Item dated April 13, 2010 and Planning Commission Resolution dated July 17, 2008 (The complete Staff Report is available at: www.co.fresno.ca.us/PlanningCommission)
6. Time extension request letter

ENVIRONMENTAL DETERMINATION:

The subject property is located within the boundaries of the Millerton New Town Specific Plan. An Environmental Impact Report (EIR) and Mitigation Measures & Monitoring Program Matrix was certified as having been prepared and considered by the decision-making body in accordance with the California Environmental Quality Act (CEQA) when the Specific Plan was adopted in 1984. Several additional environmental studies have been prepared in the interim.

An Environmental Assessment (Initial Study No. 5409) was prepared for Vesting Tentative Tract Map No. 5430 under the provisions of CEQA, resulting in the determination that the previously-certified EIR and Addendum for the Millerton New Town Specific Plan remain adequate for the project. Section 15162(b) of the CEQA Guidelines states that once an EIR and/or Mitigated Negative Declaration has been certified for a project, no subsequent EIR or Mitigated Negative Declaration shall be prepared unless: 1) substantial changes are proposed to the project; 2) substantial changes occur with respect to the circumstances under which the project is undertaken; or 3) new information of substantial importance is presented which was not known and could not have been known at the time the previous Mitigated Negative Declaration was adopted.

Staff has not received any comments or information that the circumstances noted in the above Conditions are present. Therefore, it has been determined that no further CEQA documentation is required for the subject proposal.

PUBLIC NOTICE:

Notices were sent to 37 property owners within 600 feet of the subject property, exceeding the minimum notification requirements prescribed by the California Government Code and County Zoning Ordinance.

PROCEDURAL CONSIDERATIONS:

The State Subdivision Map Act provides that prior to the expiration of a Tentative Map, a subdivider is entitled to file a "Final Map" for recording with the County if it conforms to the approved Tentative Map and certain mandatory requirements. Except for special circumstances specified in the Map Act, a Tentative Map expires two years after its approval unless extensions

are granted by the local agency. Such extensions may not exceed a total of six years. Under the terms of the Fresno County Subdivision Ordinance, time extensions may be granted by the Planning Commission upon application by the subdivider prior to the expiration date.

Starting in 2008, the State of California passed six separate Bills to give subdividers time extensions for Tentative Maps that met certain criteria. These Bills are:

- 1) Senate Bill (SB) 1185 approved 2008, Map Act Section 66452.21, granted an automatic one-year time extension.
- 2) Assembly Bill (AB) 333 approved 2009, Map Act Section 66452.22, granted an automatic two-year time extension.
- 3) Assembly Bill (AB) 208 approved 2011, Map Act Section 66452.23, granted an automatic two-year time extension.
- 4) Assembly Bill (AB) 116 approved 2013, Map Act Section 66452.24, granted an automatic two-year time extension.
- 5) Assembly Bill (AB) 1303 approved 2015, Map Act Section 66452.25, granted an automatic two-year time extension.
- 6) Assembly Bill (AB) 2973 approved 2018, Map Act Section 66452.26, granted a discretionary two-year time extension provided the project meets the requirements related to project approval date and time extension filing date according to Section 66452.25 of the Subdivision Map Act.

Granting an extension of a Tentative Map is discretionary, although the Planning Commission's discretion is limited to questions of time. The Commission cannot condition the grant of extension unless the Applicant agrees to such additional conditions. If the Applicant does not agree to such additional conditions, the Commission may deny the extension if it finds, based on the evidence, that the project will be injurious to public health, safety or general welfare if the additional conditions are not imposed.

BACKGROUND INFORMATION:

On July 17, 2008, the Planning Commission approved Vesting Tentative Tract Map No. 5430, Classified Conditional Use Permit No. 3136 and Site Plan Review No. 7655, authorizing the development of a 179.57-acre planned residential development consisting of 561 single-family residential lots. The item was appealed to the Board of Supervisors on August 1, 2008, and at its hearing of April 13, 2010, the Board denied the appeal and upheld the Planning Commission's approval.

Prior to staff's determination that the Tentative Map would expire on April 13, 2012, a series of legislative time extension were passed, approving automatic time extensions for the Tentative Map, resulting in a new expiration date of April 13, 2018. Subsequently, the first discretionary one-year time extension was approved by the Planning Commission on March 29, 2018 extending the expiration date to April 13, 2019. On March 28, 2019, the Planning Commission approved a two-year time extension under the provisions of Map Act Section 66462.26 (AB 2973) which extended the expiration date to April 13, 2021. The current request is to allow a second one-year discretionary time extension which would extend the expiration date to April 13, 2022. The Applicant filed the subject request on December 7, 2020.

Action	Approval Date	Usable Life	Expiration Date
Tentative Map Approved	4/13/2010	2	4/13/2012
AB 208	Auto	+2	4/13/2014
AB 116	Auto	+2	4/13/2016
AB 1303	Auto	+2	4/13/2018
1St PC Time Extension	3/29/2018	+1	4/13/2019
AB 2973	4/28/2019	+2	4/13/2021

ANALYSIS/DISCUSSION:

Tentative Tract Map No. 5430 was originally approved on July 17, 2008 concurrently with Classified Conditional Use Permit (CUP) No. 3136 and Site Plan Review No. 7655 based on a determination that the required CUP findings could be made. Attached is a copy of the original Subdivision Review Committee Report and Staff Report with Planning Commission Resolution and Board of Supervisors Report. According to the Applicant, the subject request is necessary to allow additional time to complete a new comprehensive Infrastructure Plan and Phased Development Plan for the project.

The current time extension request was routed to the same agencies that reviewed the original project and previous time extensions. None of those agencies identified any change in circumstances or the need for additional conditions and did not express any concerns with the proposed extension of time.

PUBLIC COMMENT:

None.

CONCLUSION:

Staff believes this one-year discretionary time extension for Vesting Tentative Tract Map No. 5430 should be approved, based on the factors cited in the analysis above. Approval of this time extension will extend the expiration date to April 13, 2022.

PLANNING COMMISSION MOTIONS:

Recommended Motion (Approval Action)

- Move to approve the one-year discretionary time extension for Vesting Tentative Tract Map No. 5430; and
- Direct the Secretary to prepare a Resolution documenting the Commission’s action.

Alternative Motion (Denial Action)

- Move to deny the one-year discretionary time extension request for Vesting Tentative Tract Map No. 5430 (state reasons how approval of the time extension request would pose a health and safety issue to the residents of the subdivision or the immediate community, or

both; or state how denial of the time extension request is required in order to comply with State or Federal law); and

- Direct the Secretary to prepare a Resolution documenting the Commission's action.

JS:im

G:\4360Devs&PIn\PROJSEC\PROJDOCS\TT\5400-5499\5430\EXT 2\SR\TT5430 Ext 2 SR.docx

LOCATION MAP



TT 5430 EXT 2

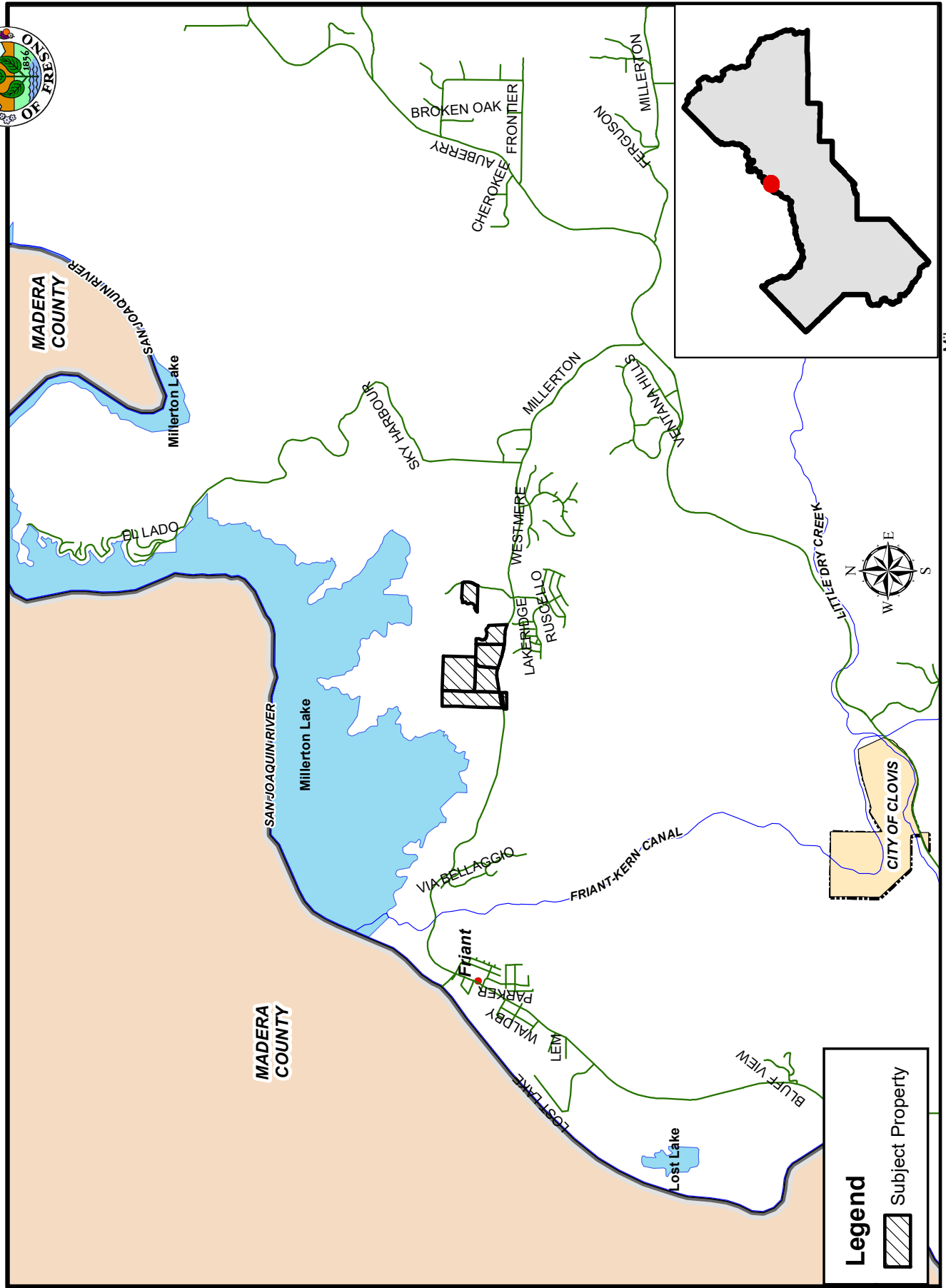

EXISTING LAND USE MAP

TT 5430 EXT 2

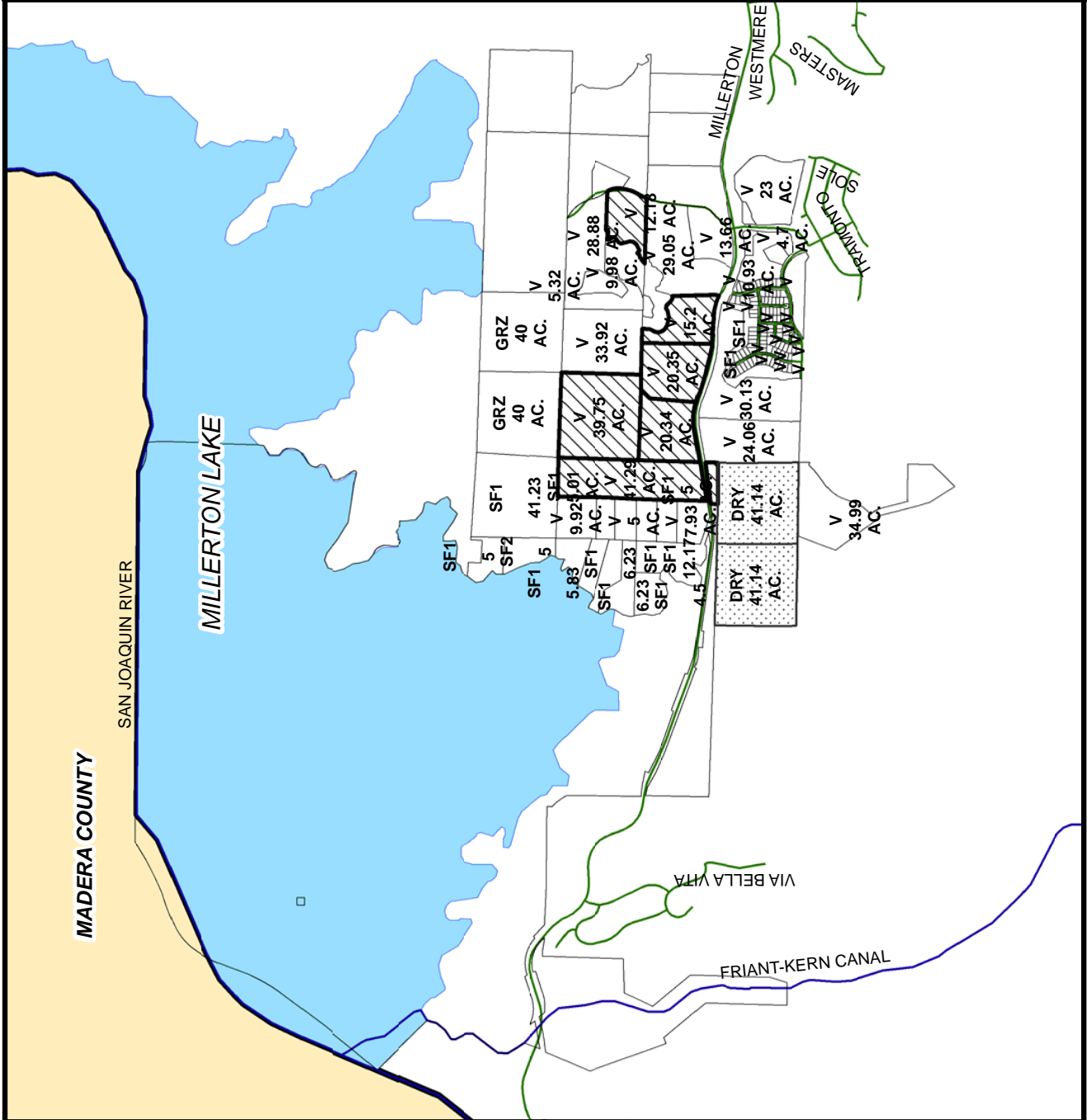
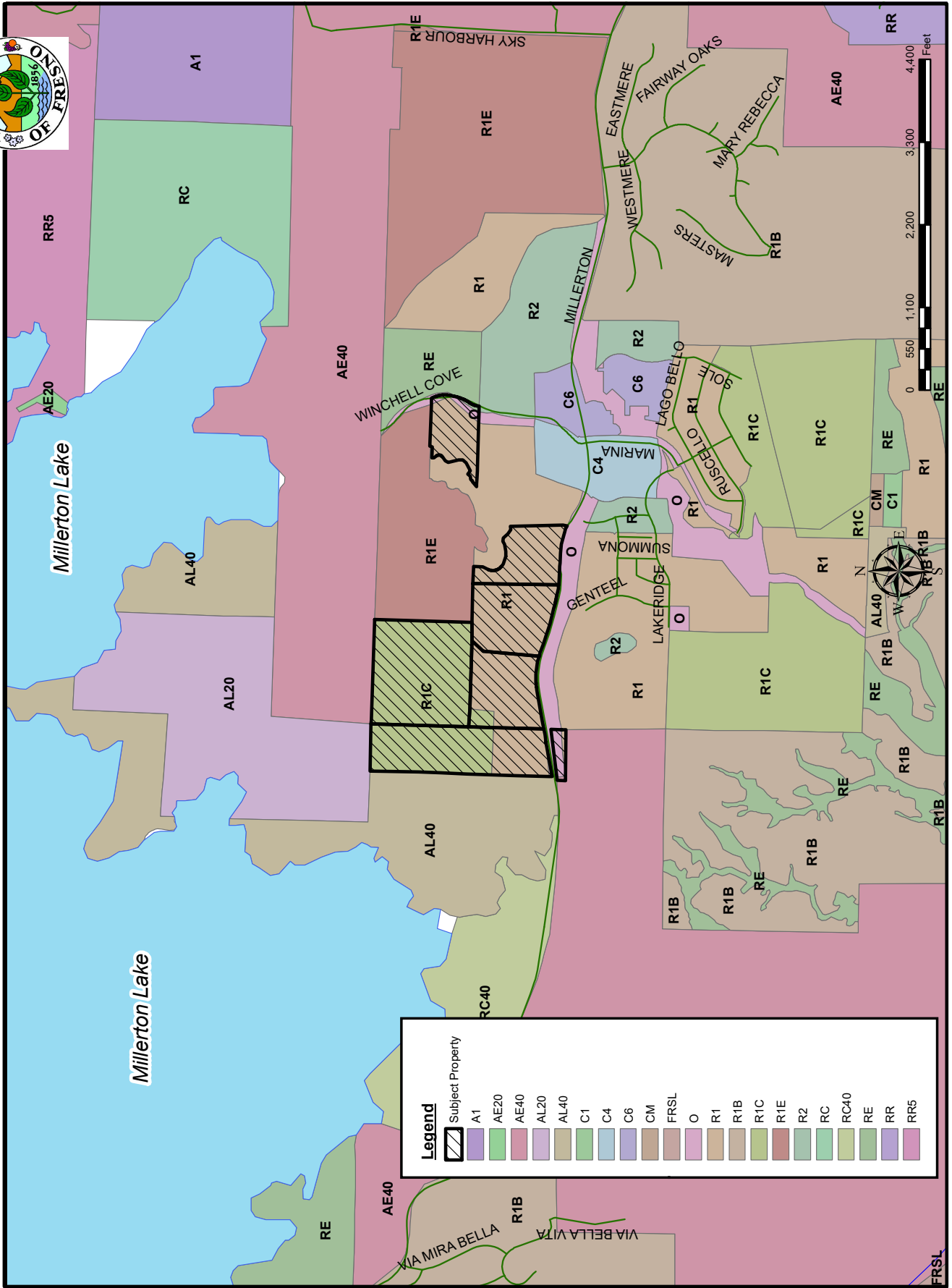
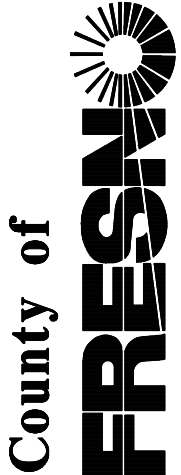

EXHIBIT 3

EXISTING ZONING MAP

TT 5430 EXT 2
STR 9&10- 11/21





VESTING TENTATIVE SUBDIVISION MAP TRACT NO. 5430

IN THE COUNTY OF FRESNO CONSISTING OF FIVE SHEETS SHEET ONE



Tract No. 5430 Date 08/22/07

Fresno County Planning Commission 2220 Tulare Street Fresno, California 93721

I hereby apply for approval of the attached Tentative Tract Map. The acreage of this tract is 1,79.57±. There will be 561 RESIDENTIAL UNITS PER TRACT lots in this tract with a minimum lot size of 4,500 square feet. The existing use of this property is IDLE. The proposed use of this property is RESIDENTIAL. The existing zoning on this property is R-1(G) and R-1(G)(2). The proposed zoning on this property is R-1(G) and R-1(G)(2). The existing structures on this property include NONE. The existing easements on this property include AS SHOWN. All improvements will conform to County Standards with the following exceptions: N/A.

Type of street trees to be planted are AS PER OPERATIONAL STATEMENT PER COUNTY REQUIREMENTS feet. The intervals of these trees will be PER COUNTY REQUIREMENTS feet. The proposed drainage, flood control measures and method of storm water disposal is CSA No. 34 AND SEDIMENTATION BASIN. The proposed fire hydrant and water flow will conform to County Standards. Fire hydrants will be installed at intervals of PER COUNTY REQUIREMENTS feet. The proposed source of water supply is CSA No. 34. The proposed method of sewage disposal is CSA No. 34. The following utilities are to be provided ELECTRICAL, CATV, PROPANE AND TELEPHONE arrangements (have) (have not) been made with utility companies serving this area.

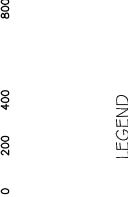

Signature of Agent Name A. BEN EWELL, JR. Signature of Engineer Name PROVOST AND FRITCHARD THE CLARKSFIELD COMPANY, INC. ENGINEERING GROUP Address 466 W. FALLBROOK, # 101 Address 206 W. CROWMELL AVE City FRESNO, Phone 437-1990 City FRESNO, Phone 449-2700

OWNER'S CERTIFICATE

I, (as the record owner of) (have an option or contract to purchase) the property (shown on the Tentative Map of Tract No. 5430) that I have examined the map and consent to its submission to the Fresno County Planning Commission for consideration.

Signature Name Address City Phone

Table with project details: THE CLARKSFIELD COMPANY, INC., IN THE COUNTY OF FRESNO STATE OF CALIFORNIA, LAKE RIDGE COMMUNITIES TENTATIVE TRACT MAP NO. 5430, DESIGN ENGINEER WILLIAM WASHBURN, DATE 2/08/2008, C.E. LICENSE NO. 60322, SHEET 1 OF 5.

PROVOST & FRITCHARD logo and contact information: 206 WEST CROWMELL AVENUE, FRESNO, CALIFORNIA 93704, 559/446-2700 FAX 559/469-2715, www.provostandritchard.com

LEGAL DESCRIPTION

That certain real property situated in Section 10, Township 11 North, Range 21 East, Merced District Base and Meridian, in the County of Fresno, State of California, according to the official plat thereof, being a portion of Parcel 17, of Parcel Map No. 3179, according to the amended map thereof, recorded in Book 34 of Parcel Maps at Page 94, Fresno County Records, being more particularly described as follows: Beginning at the southwest corner of said Parcel 17, of said Parcel Map, thence North 02° 27' 46" East, along the west line of said Parcel 17, a distance of 1127.69 feet to the northwest corner of said Parcel 17; thence South 88° 01' 40" East, along the north line of said Parcel 17, a distance of 213.50 feet; thence South 88° 01' 40" East, along the east line of said Parcel 17, a distance of 73.98 feet to the beginning of a tangent curve, concave easterly, and having a radius of 150.00 feet; thence South 51° 58' 10" East, a distance of 38.42 feet; thence South 43° 47' East, a distance of 46.90 feet; thence South 44° 28' 34" East, a distance of 80.51 feet; thence South 45° 18' East, a distance of 67.72 feet; thence North 88° 43' 52" East, a distance of 40.44 feet to a point on the east line of said Parcel 17; thence South 02° 27' 56" West, along said east line, a distance of 730.34 feet to southeast corner of said Parcel 17, said point being the beginning of a non-tangent curve, concave southerly, and having a radius of 1029.92 feet, a radial to said point bears North 17° 50' 52" East; thence westerly, following the southerly boundary of said Parcel 17, along the arc of said non-tangent curve, through a central angle of 15° 59' 14", an arc distance of 297.38 feet; thence North 88° 08' 22" West, tangent curve, through a central angle of 07° 13' 55", an arc distance of 210.77 feet to the Point of Beginning.

UNIT ALLOCATION # LOT SIZE MAP

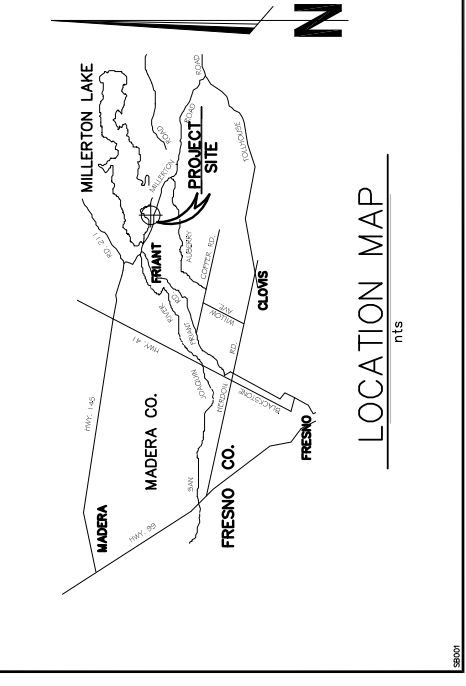

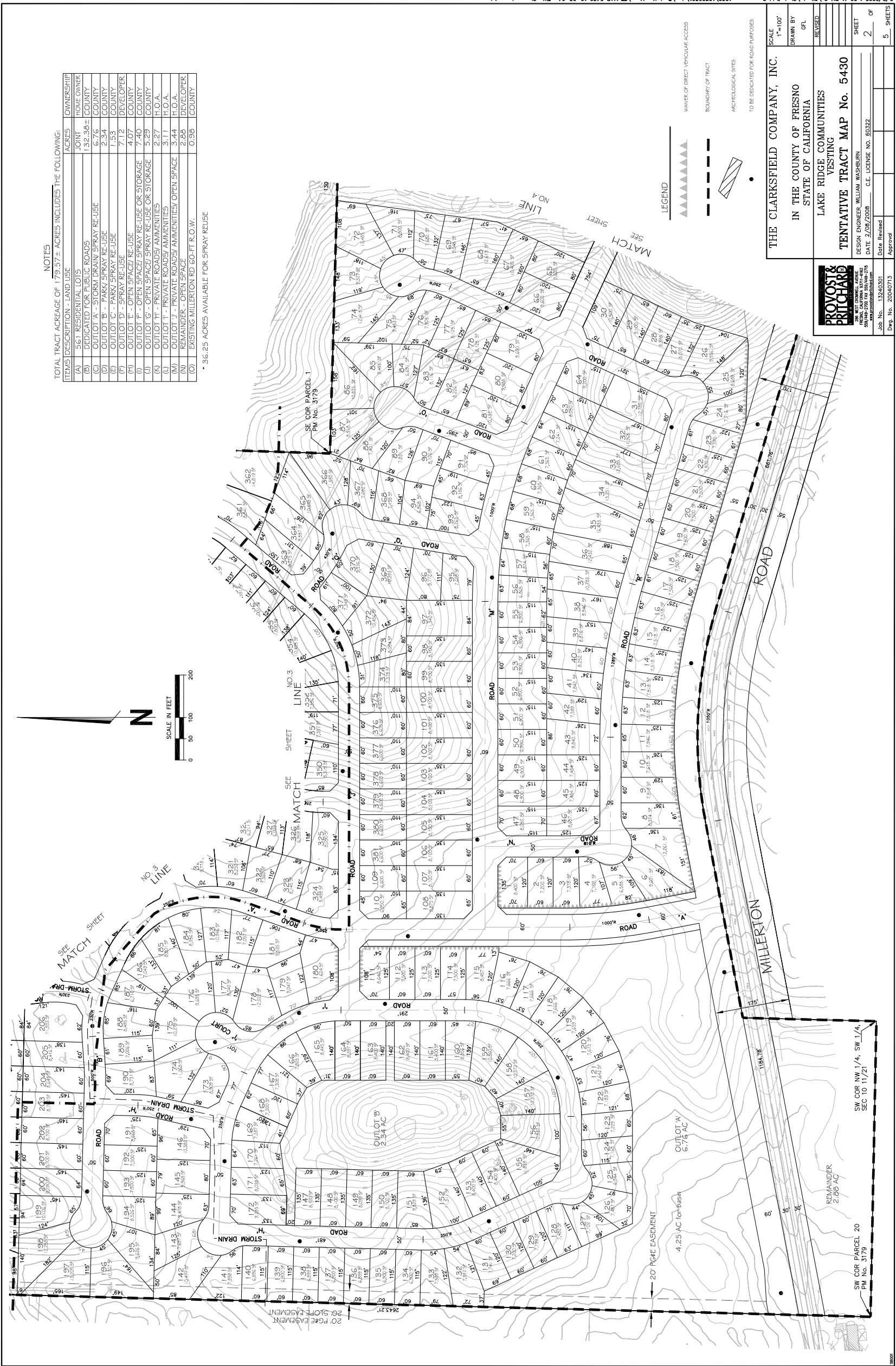

NOTES
TOTAL TRACT AREA OF 179.57± ACRES INCLUDES THE FOLLOWING:

ITEMS DESCRIPTION - LAND USE	ACRES	OWNERSHIP
(A) 561 RESIDENTIAL LOTS	152.38±	JOINT HOME OWNER COUNTY
(B) DEDICATED FOR PUBLIC ROADS	6.75	COUNTY
(C) OUTLOT A - SPRAY REUSE	1.53	COUNTY
(D) OUTLOT B - SPRAY REUSE	7.12	PRIVILEGE
(E) OUTLOT C - SPRAY REUSE	4.07	COUNTY
(F) OUTLOT D - OPEN SPACE/RE-USE	2.27	H.O.A.
(G) OUTLOT E - OPEN SPACE/RE-USE OR STORAGE	5.23	COUNTY
(H) OUTLOT F - PRIVATE ROADS/AMENITIES	3.11	H.O.A.
(I) OUTLOT G - PRIVATE ROADS/AMENITIES/OPEN SPACE	3.44	H.O.A.
(J) REMAINDER - OPEN SPACE	2.85	DEVELOPER
(K) EXISTING MILLERTON RD 60-FT R.O.W.	0.93	COUNTY

• 36.25 ACRES AVAILABLE FOR SPRAY REUSE

LEGEND

- ▲▲▲▲▲▲▲▲ WALKER OF DIRECT VEHICULAR ACCESS
- BOUNDARY OF TRACT
- ARCHEOLOGICAL SITES
- TO BE DEDICATED FOR ROAD PURPOSES

THE CLARKSFIELD COMPANY, INC.
IN THE COUNTY OF FRESNO
STATE OF CALIFORNIA

**LAKE RIDGE COMMUNITIES
VESTING
TENTATIVE TRACT MAP NO. 5430**

DESIGN ENGINEER: WILLIAM WASHBURN
DATE: 2/25/2008 C.E. LICENSE NO. 65322

Job No. 13240301
Date Retired
Approval

Scale: 1"=100'
DRAWN BY: GFL
REVISIONS:
SHEET: 2 OF 5
SHEETS

PROVOST & PRICHARD
200 S. 31ST AVENUE, SUITE 100
ARROYO GRANDE, CA 93021
www.provostprichard.com

Job No. 13240301
Date Retired
Approval

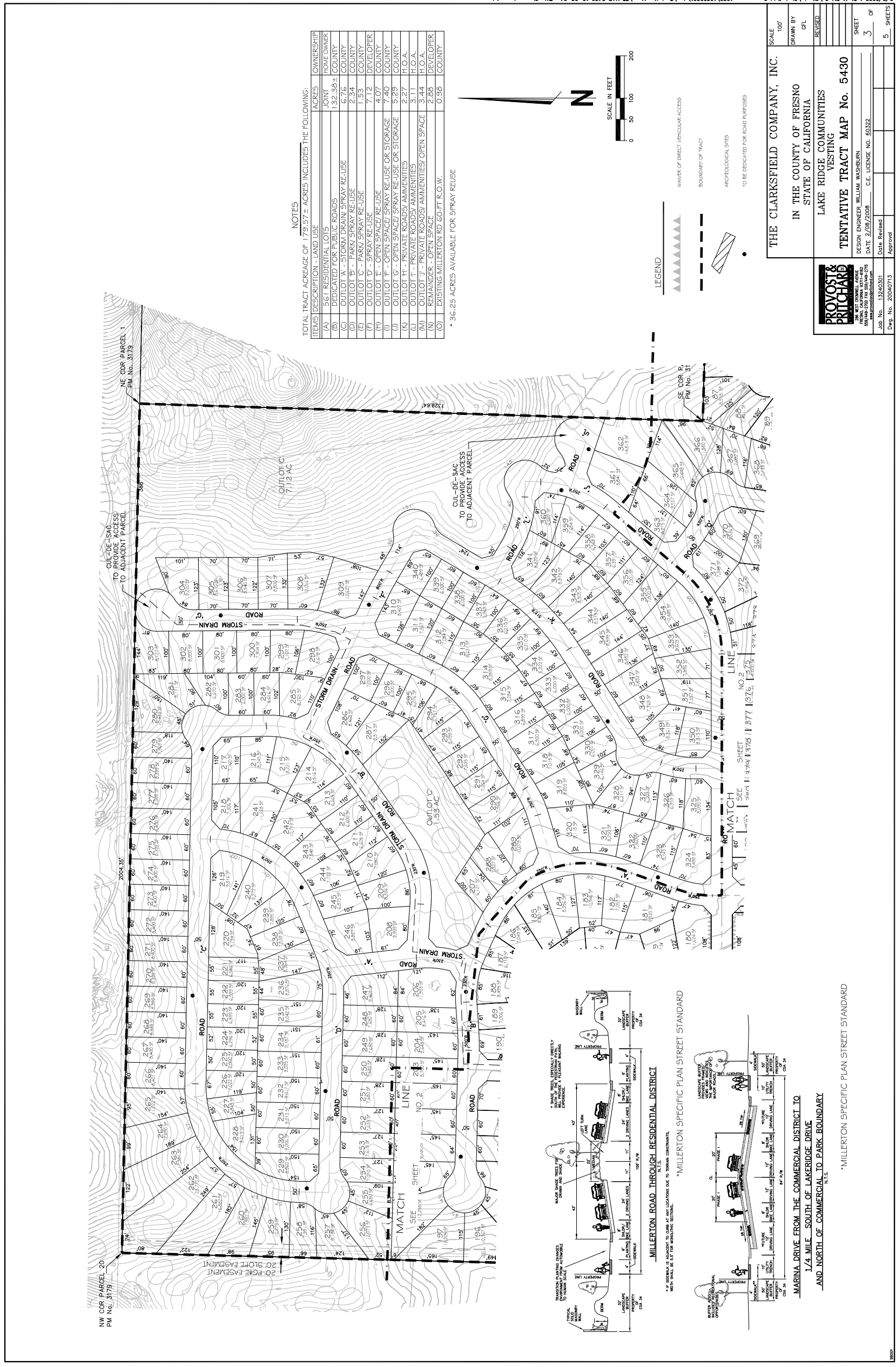

NW COR PARCEL 20
PM No. 3179

NE COR PARCEL 1
PM No. 3179

20' SLOPE FASTENMENT

CUL-DE-SAC
TO ADJACENT PARCEL

SE COR P.
PM No. 31

NOTES

TOTAL TRACT AREA OF 1,791.57 ± ACRES INCLUDES THE FOLLOWING:

ITEMS	DESCRIPTION - LAND USE	ACRES	OWNERSHIP
(A)	56 F RESIDENTIAL LOTS	152.36±	JOINT HOME OWNER COUNTY
(B)	DEDICATED FOR PUBLIC ROADS	6.76	COUNTY
(C)	OUTLOT A - STORM DRAIN SPRAY RE-USE	2.34	COUNTY
(D)	OUTLOT B - PARKY SPRAY RE-USE	7.35	COUNTY
(E)	OUTLOT C - STORM DRAIN RE-USE	4.02	COUNTY
(F)	OUTLOT D - OPEN SPACE/ REUSE	7.40	COUNTY
(G)	OUTLOT E - OPEN SPACE/ REUSE OR STORAGE	5.29	COUNTY
(H)	OUTLOT F - PRIVATE ROADS/ AMENITIES	2.27	H.O.A.
(I)	OUTLOT G - PRIVATE ROADS/ AMENITIES	3.11	H.O.A.
(J)	OUTLOT H - PRIVATE ROADS/ AMENITIES/ OPEN SPACE	3.44	H.O.A.
(K)	REMAINDER - OPEN SPACE	2.88	DEVELOPER
(L)	EXISTING MILLERTON RD 60-FT R.O.W.	0.98	COUNTY

- 36.25 ACRES AVAILABLE FOR SPRAY REUSE

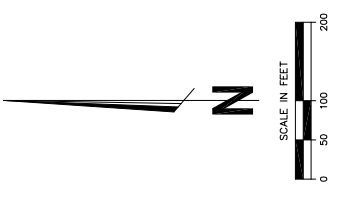

THE CLARKSFIELD COMPANY, INC.
IN THE COUNTY OF FRESNO
STATE OF CALIFORNIA
LAKE RIDGE COMMUNITIES
VESTING
TENTATIVE TRACT MAP NO. 5430

DESIGN ENGINEER WILLIAM WASHBURN
DATE 2/25/2008 C.E. LICENSE NO. 65322

Job No. 13240301
Date Revised
Approval

SCALE 100'
DRAWN BY GFL
REVISIONS
SHEET 3 OF 5 SHEETS

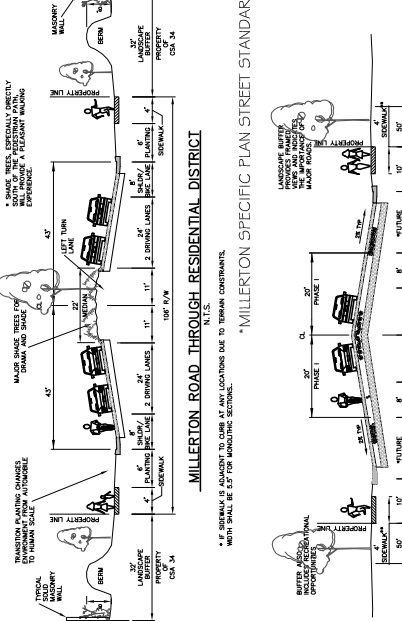

MILLERTON ROAD THROUGH RESIDENTIAL DISTRICT
MILLERTON SPECIFIC PLAN STREET STANDARD

MARINA DRIVE FROM THE COMMERCIAL DISTRICT TO
1/4 MILE SOUTH OF LAKERIDGE DRIVE
AND NORTH OF COMMERCIAL TO PARK BOUNDARY
N.L.S.

MILLERTON SPECIFIC PLAN STREET STANDARD

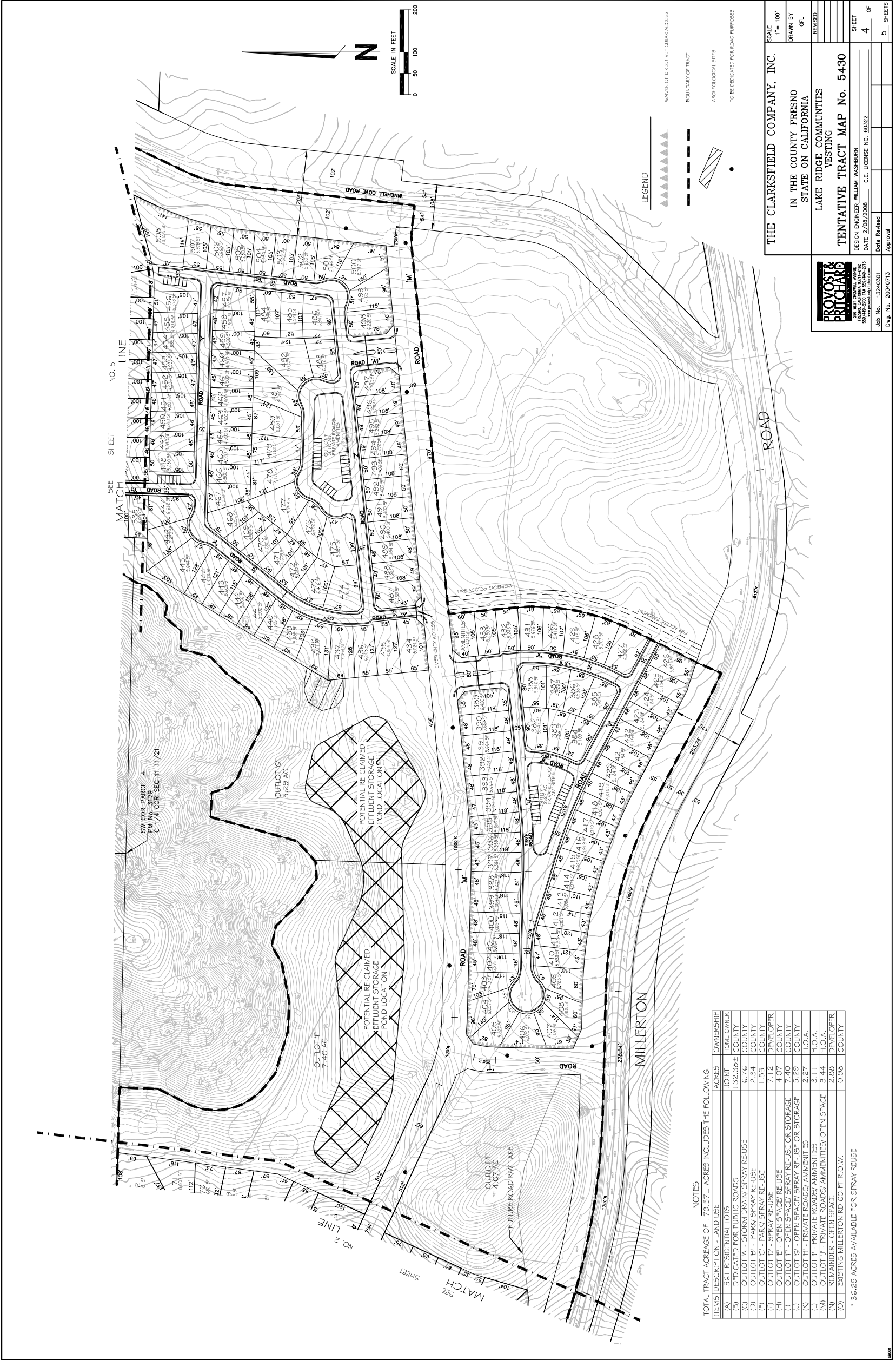

NOTES

TOTAL TRACT AREA OF 179.57 ± ACRES INCLUDES THE FOLLOWING:

ITEMS DESCRIPTION - LAND USE	ACRES	OWNERSHIP
(A) 56.1 RESIDENTIAL LOTS	132.36 ±	JOINT HOME OWNER COUNTY
(B) DEDICATED FOR PUBLIC ROADS	6.76	COUNTY
(C) OUTLOT A - STORM DRAIN SPRAY RE-USE	2.34	COUNTY
(D) OUTLOT B - PARK SPRAY RE-USE	1.53	COUNTY
(E) OUTLOT C - PARK SPRAY RE-USE	7.12	DEVELOPER
(F) OUTLOT D - SPRAY RE-USE	4.07	COUNTY
(G) OUTLOT E - OPEN SPACE/ SPRAY RE-USE OR STORAGE	7.40	COUNTY
(H) OUTLOT F - OPEN SPACE/ SPRAY RE-USE OR STORAGE	5.29	COUNTY
(I) OUTLOT G - PRIVATE ROADS/ AMMENITIES	3.11	H.O.A.
(J) OUTLOT H - PRIVATE ROADS/ AMMENITIES	3.44	H.O.A.
(K) REMAINDER - OPEN SPACE	2.88	DEVELOPER
(L) EXISTING MILLERTON RD 60-FT R.O.W.	0.98	COUNTY

* 36.25 ACRES AVAILABLE FOR SPRAY REUSE

PROVOST & RICHARD
 200 WEST DAVENPORT AVENUE
 SUITE 100
 FRESNO, CALIFORNIA 93710-4102
 TEL: 559.233.8888
 FAX: 559.233.8889
 WWW.PROVOSTANDRICHARD.COM

Job No. 13240301
 Date Revised
 Approval

DESIGN ENGINEER WILLIAM WASHBURN
 DATE 2/29/2008 C.E. LICENSE NO. 65322

THE CLARKSFIELD COMPANY, INC.
 IN THE COUNTY FRESNO
 STATE OF CALIFORNIA
 LAKE RIDGE COMMUNITIES
 VESTING
TENTATIVE TRACT MAP NO. 5430

SCALE 1" = 100'
 DRAWN BY GFL
 SHEET 4 OF 5 SHEETS

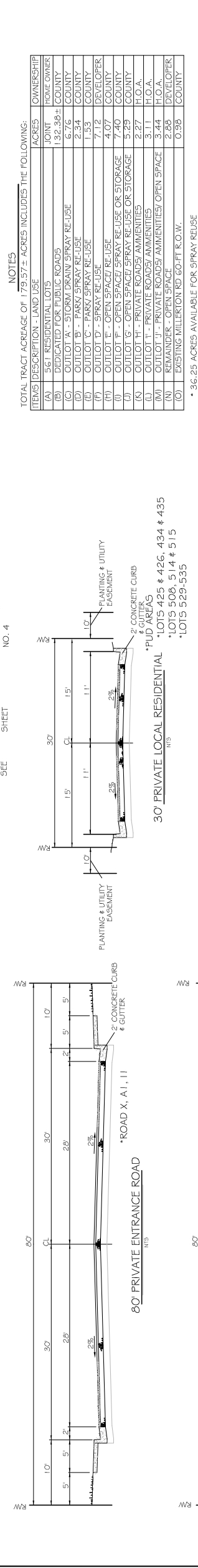
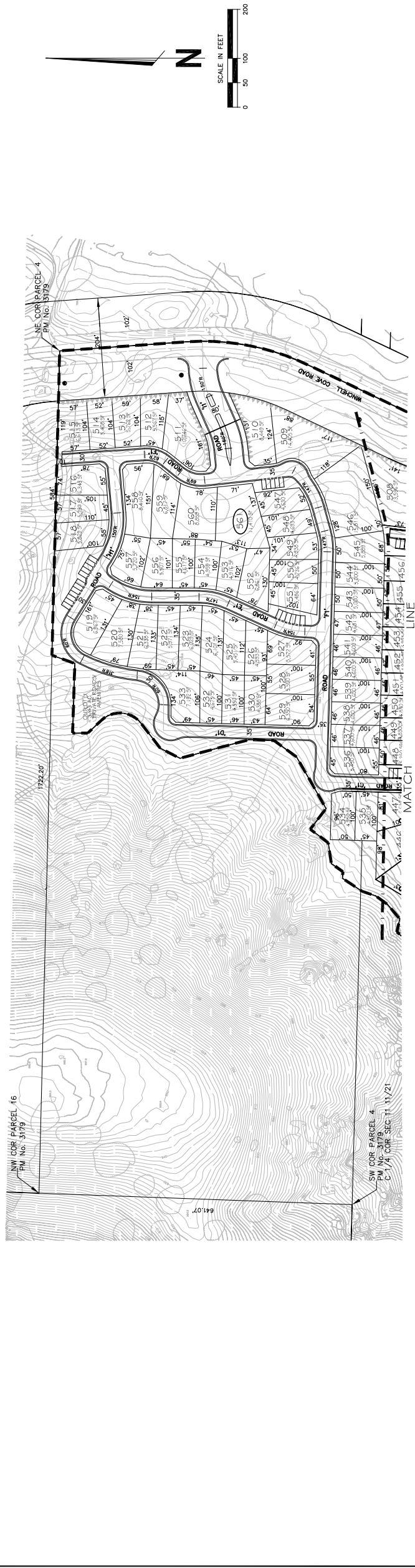
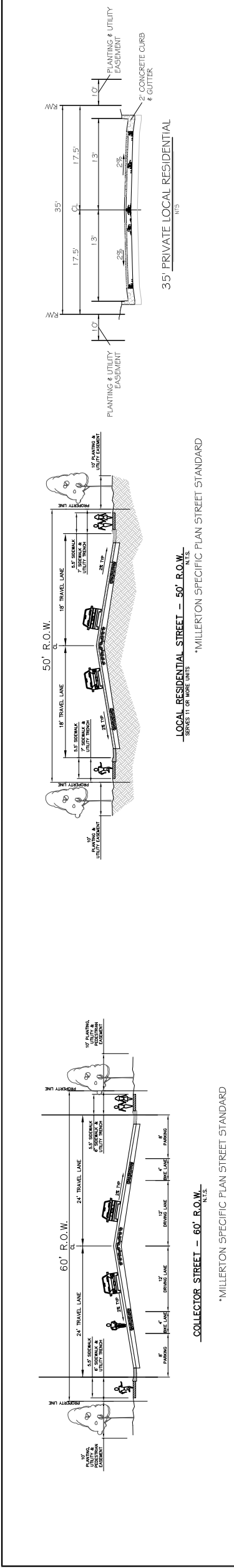

NOTES

TOTAL TRACT AREA OF 179.57± ACRES INCLUDES THE FOLLOWING:

ITEMS DESCRIPTION - LAND USE	ACRES	OWNERSHIP
(A) 561 RESIDENTIAL LOTS	132.39±	JOINT HOME OWNER
(B) DEDICATED FOR PUBLIC ROADS	1.92±	COUNTY
(C) OUTLOT - SPRAY RE-USE	6.24	COUNTY
(D) OUTLOT - PARK SPRAY RE-USE	1.53	COUNTY
(E) OUTLOT 'D' - SPRAY RE-USE	7.12	DEVELOPER
(F) OUTLOT 'E' - OPEN SPACE/ RE-USE	4.07	COUNTY
(G) OUTLOT 'G' - OPEN SPACE/ SPRAY RE-USE OR STORAGE	7.40	COUNTY
(H) OUTLOT 'H' - PRIVATE ROADS/ AMENITIES	5.29	COUNTY
(I) OUTLOT 'I' - PRIVATE ROADS/ AMENITIES	3.11	H.O.A.
(J) OUTLOT 'J' - PRIVATE ROADS/ AMENITIES/ OPEN SPACE	3.44	H.O.A.
(K) REMAINDER - OPEN SPACE	2.85	DEVELOPER
(L) EXISTING MILLERTON RD 60' FT R.O.W.	0.95	COUNTY

* 36.25 ACRES AVAILABLE FOR SPRAY REUSE

THE CLARKSFIELD COMPANY, INC.
 IN THE COUNTY FRESNO
 STATE OF CALIFORNIA

LAKE RIDGE COMMUNITIES
 VESTING

TENTATIVE TRACT MAP NO. 5430

DESIGN ENGINEER: WILLIAM WASHBURN
 DATE: 2/29/2008 C.E. LICENSE NO. 66322

Job No. 13240301 Date Revised Approval
 Drawn By GFL
 Revised
 SHEET 5 OF 5 SHEETS



Inter Office Memo

DATE: April 13, 2010

TO: Board of Supervisors

FROM: Alan Weaver, Director *Alan Weaver*
 Department of Public Works and Planning

SUBJECT: Initial Study Application No. 5409, Classified Conditional Use Permit Application No. 3136, Site Plan Review Application No. 7655, and Vesting Tentative Tract Application No. 5430 (Clarksfield Company) – Appellant: George Nokes, Revive the San Joaquin

RECOMMENDED ACTION

Consider and take action on appeal filed by George Nokes with Revive the San Joaquin of the Planning Commission's approval of Vesting Tentative Tract Application No. 5430, Site Plan Review Application No. 7655, Initial Study Application No. 5409, and Classified Conditional Use Permit Application No. 3136 proposing to allow a planned residential development within the County-adopted Millerton Specific Plan consisting of 561 single-family residential lots with private roads on approximately 179.57-acres of land in the R-1 (c) and R-1-C (c) Districts.

BACKGROUND / DISCUSSION

This item comes to your Board on appeal of the Planning Commission's approval of the subject applications.

The subject proposal is located within the boundary of the Millerton Specific Plan. By way of background, the Specific Plan was originally approved in December of 1984 as a "New Town" as provided for in the Sierra-North Regional Plan policies and was subsequently amended in 1999 and 2004 expanding the boundaries of the Plan area, and incorporating updates resulting from the 2000 General Plan Update. The Millerton Specific Plan today is a planned community on 1,420 acres planned to accommodate a population of 8,000 to 10,000 in approximately 3,499 residential units. The Plan also provides for commercial/retail and recreational uses.

Since the adoption of the Specific Plan there have been five vesting tentative tract maps totaling 1,132 residential lots on approximately 551.80 acres of land and four conditional use permits authorizing recreational and hotel/conference center related uses approved for the Specific Plan area in addition to the current proposal under appeal. Pages four through six of the attached July 17, 2008 Subdivision Review Committee Report provides additional background on Millerton New Town and its associated projects.

On July 17, 2008, the Planning Commission considered the subject project. The project site is located within the Millerton Specific Plan, north of Millerton Road between Winchell Cove Road and the Friant-Kern Canal, approximately 1.8 miles east of the unincorporated community of Friant. Staff notes that considerable time was spent responding to then Planning Commissioner Chris Acree's questions relating to the project's consistency with the County's General Plan as well as water supply issues and the need to prepare a Water Assessment pursuant to Senate Bill 610 and Senate Bill 221. Staff noted that the project was consistent with the adopted Specific Plan, which was previously determined to be consistent with the Sierra North Regional Plan and General Plan at the time of Plan adoption in 1984. In addition, staff summarized the existing surface water agreements that are proposed to serve the project and that those agreements represented an adequate and secure water supply.

After considering public testimony from the applicant and applicant's representative and two other individuals with project related concerns (access easement and water supply), the Commission, by a vote of five to one, adopted Resolution No. 12112, adopting the Mitigated Negative Declaration prepared for the project, adopting the recommended findings of fact in the Subdivision Review Committee Report and Staff Report, and approving Vesting Tentative Tract Application No. 5430, including approval of the exception request for modified 30 and 35 foot wide private residential streets, associated Site Plan Review Application No. 7655, and Classified Conditional Use Permit Application No. 3136.

An appeal was filed by Mr. George Nokes, Chairman of Revive the San Joaquin on August 1, 2008 to your Board for consideration. The appeal in part cited that a sustainable water supply for the proposed development was unverified. Upon review of the appeal, staff concluded that while an adequate source of water supply is available to serve the proposal, a Water Assessment was required to be prepared because the proposed project represents a residential development of more than 500 dwelling units. Pursuant to the California Environmental Quality Act (CEQA), a Water Assessment must be prepared for residential developments that exceed 500 dwelling units.

In response the County retained Provost and Pritchard to conduct a Water Supply Assessment (WSA) for this project in compliance with Section 10910 of the California Water Code. Section 10910, et seq requires the water purveyor, in this case County Service Area No. 34, to prepare the Water Supply Assessment prior to project approval. The WSA must be included with the environmental document addressing the potential environmental impacts of the project. It must evaluate whether the supply of domestic water available to the development is adequate, and that this supply will continue to be adequate over the next 20 years, during normal, dry, and multiple-dry years.

The completed WSA document was provided to the County in January of 2010. A summary of the findings of the WSA has been incorporated into the environmental document prepared for this project (Mitigated Negative Declaration prepared for Initial Study No. 5409, attached as Exhibit 6 to the July 17, 2008 Subdivision Review Committee Report and Exhibit 7 to the July 17, 2008 Planning Commission Staff Report). The WSA demonstrates that the water supply agreements serving the proposed development are adequate per the specifications of Section 10910. The information provided in the WSA reaffirms a total of 1,520 annual acre feet water reserved under the Joint Water Management Exchange Agreement, which is referred to in the adopted CSA No. 34 WSA as Agreement No. 1, of which 308 acre-feet is reserved for the subject 180-acre tract.

This will generate a consistent water supply for the proposed development and for existing and planned future uses within the current County Service Area No. 34 Western Service Area over the next 20 years. Subsequently, the WSA was taken before your Board on behalf of County Service Area No. 34 on March 2, 2010 and approved.

The proposal's estimated average annual demand of 303 acre-feet (AF) would be satisfied with a portion of the surface water supplies provided via long-term surface water agreements committed to serve the currently-approved and proposed developments within County Service Area No. 34. The key supply agreements include the provision of long-term surface water between the County and the Arvin-Edison Water Storage District for 1,520 AF of "firm" supply from the Central Valley Project (CVP), "back-up" shortfall supply, covered by long-term surface water availability from a "shortfall" Water Supply Agreement between the County of Fresno and a Lower Tule River Irrigation District Agreement for up to 1,520 AF of Class 1 supply; and a Water Supply Agreement between the County of Fresno and Deer Creek Tule River Association for 770 AF of Class 1 supply.

As part of the process of securing approvals and infrastructure necessary to serve the project, County Service Area No. 34 will participate in the United States Bureau of Reclamation's approval process for the National Environmental Protection Act (NEPA) approval of water use within the Place of Use for the project, designate the project as a separate Zone of Benefit within the CSA 34 service area and approve a Water Service Agreement for the project, participate in the Fresno County approval process for the various phases of the project, mandate construction of all necessary water infrastructure in accordance with the County Service Area's Infrastructure Master Plan as phases are proposed, and construct (or inspect developer's construction of) the required infrastructure improvements, and verify that infrastructure is ready to be placed in service prior to occupancy of homes in the corresponding Project phases.

As final action by your Board has not occurred on the subject applications, the environmental document associated with this project (Mitigated Negative Declaration prepared for Initial Study Application No. 5409), has not yet been adopted. Per Subsections 15073.5(c)(2)(4) of the California Environmental Quality Act, which specifically addresses recirculation of a Negative Declaration prior to adoption, recirculation of the subject project's environmental document is unnecessary due to the determination that new project revisions were added in response to written and verbal comments on the project's effects identified in the proposed negative declaration which are not new avoidable significant effects, and new information that has been added to the negative declaration that merely clarifies and amplifies the environmental document.

While the Water Assessment was being prepared, Department staff met with Mr. Nokes, and Mr. Acree, who is now the Executive Director of Revive the San Joaquin to further discuss the appeal. Representatives of Revive the San Joaquin requested and were provided information relating to their Water Assessment and General Plan consistency questions.

If your Board determines to uphold the Planning Commission's approval of the project, a simple denial motion would be appropriate. If your Board were inclined to grant the appeal, a motion to uphold the appeal indicating which of the required findings cannot be made would be appropriate.

Should your Board approve the project, staff would request that two additional conditions be added in the approval motion. The first condition addresses the need for the applicant to indemnify the County for any and all legal costs associated with the County's approval of the project. The second condition is a mandatory requirement of the State Subdivision Map Act that addresses the need for an available and sufficient water supply to serve the project prior to recordation of the final map. The two proposed conditions are as follows:

1. The applicant shall enter into an agreement indemnifying the County for any and all legal costs associated with its approval of Initial Study Application No. 5409, Vesting Tentative Tract Map Application No. 5430, Classified Conditional Use Permit Application No. 3136, and Site Plan Review Application No. 7655.
2. The application shall comply with all provisions of the California Water Code in accordance with the requirements of Section 10910, et seq.

G:\4360Devs&PIn\ADMIN\BOARD\Board Items\2010\4-13-10\Clarksfield_IOM.doc



Agenda Item

DATE: April 13, 2010

TO: Board of Supervisors

FROM: Planning Commission

SUBJECT: RESOLUTION NO. 12112 – INITIAL STUDY APPLICATION NO. 5409, CLASSIFIED CONDITIONAL USE PERMIT APPLICATION NO. 3136, SITE PLAN REVIEW APPLICATION NO. 7655, AND VESTING TENTATIVE TRACT MAP APPLICATION NO. 5430

APPLICANT: Clarksfield Company, Inc.
 OWNER: Clarksfield Company, Inc.

REQUEST: Allow a planned residential development consisting of 561 single-family residential lots, 10 outlots with designated uses, and one remainder lot on approximately 179.57-acres in the R-1(c) (Single-Family Residential, 6,000 square-foot minimum parcel size, Conditional) District and R-1-C (c) (Single-Family Residential, 9,000 square-foot minimum parcel size, conditional) District.

LOCATION: The subject property is located within the Millerton New Town Specific Plan, north of Millerton Road between the Winchell Cove Road and the Friant-Kern Canal, approximately 1.8 miles east of the unincorporated community of Friant (APN: 300-021-27S, 300-032-12S, 300-032-57S, 300-340-01S, 03S, 15S, 06S, and 07S).

PLANNING COMMISSION ACTION:

At its hearing of July 17, 2008, the Commission considered the Subdivision Review Committee Report, Staff Report and testimony (summarized in Exhibit "A").

ADMINISTRATIVE OFFICE REVIEW Brandi Otha Page 5 of 738
 BOARD ACTION: DATE April 13, 2010 APPROVED AS RECOMMENDED _____ OTHER _____



Official Action of
Board of Supervisors

SEE PAGE THREE FOR BOARD ACTION

UNANIMOUS _____ ANDERSON _____ CASE _____ LARSON _____ PEREA _____ POOCHIGIAN _____

A motion was made by Commissioner Milligan and seconded by Commissioner Niswander to adopt the Mitigated Negative Declaration prepared for the project; adopt the recommended findings of fact in the Subdivision Review Committee Report and Staff Report; and approve Vesting Tentative Tract Application No. 5430 and associated Site Plan Review Application No. 7655 including approval of the exception request regarding modified 30 and 35 foot private residential streets and modification to Condition No. 6 under "Other Conditions" to include language regarding water and sewer analysis as it relates to infrastructure, and addition of a new condition (Condition No. 19 "Other Conditions") clarifying provision of water permit information prior to building permit issuance; and approve Classified Conditional Use Permit Application No. 3136, with an additional Condition No. 6 under Classified Conditional Use Permit No. 3136 clarifying that solid waste pick-up will only be allowed on 35-foot wide private residential streets. Said conditions with the noted modifications and additions are listed in Exhibit "B".

This motion passed on the following vote:

VOTING: Yes: Commissioners Milligan, Niswander, Abrahamian, Woolf, Yancey
 No: Commissioner Acree
 Absent: Commissioner Gill, Goodman
 Abstain: None

ALAN WEAVER, DIRECTOR
Department of Public Works and Planning
Secretary-Fresno County Planning Commission

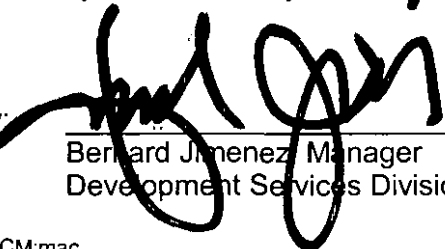
By: 
Bernard Jimenez, Manager
Development Services Division

BJ:CM:mac
G:\4360Devs&PIn\ADMIN\BOARD\Board Items\2010\4-13-10\Clarksfield_AI.doc

- NOTES: 1. The approval of the Tentative Tract Map will expire two years from the date of approval unless a Final Map is recorded in accordance with the Fresno County Subdivision Ordinance. When circumstances beyond the control of the Applicant do not permit compliance with this time limit, the Commission may grant a time extension request. Application for such extension must be filed with the Department of Public Works and Planning before the expiration of the Tentative Tract Map. The approval of Classified Conditional Use Permit No. 3136 and Site Plan Review Application No. 7655 are tied to Vesting Tentative Tract No. 5430 and will expire upon expiration of the Tentative Tract Map. Provision is made that the Conditional Use Permit and Site Plan Review may be extended in conjunction with an extension request of the tentative tract map.

Attachments

DENIED APPEAL UPHOLDING PLANNING COMMISSION'S APPROVAL; ADOPTED AMENDED MITIGATED NEGATIVE DECLARATION PREPARED OF INITIAL STUDY APPLICATION NO. 5409, AND ADDED THE FOLLOWING TWO ADDITIONAL CONDITIONS:

- 1. THE APPLICANT SHALL ENTER INTO AN AGREEMENT INDEMNIFYING THE COUNTY FOR ANY AND ALL LEGAL COSTS ASSOCIATED WITH ITS APPROVAL OF INITIAL STUDY APPLICATION NO. 5409, VESTING TENTATIVE TRACT MAP APPLICATION NO. 5430, CLASSIFIED CONDITIONAL USE PERMIT APPLICATION NO. 3136, AND SITE PLAN REVIEW APPLICATION NO. 7655.**
- 2. THE APPLICATION SHALL COMPLY WITH ALL PROVISIONS OF THE CALIFORNIA WATER CODE IN ACCORDANCE WITH THE REQUIREMENTS OF SECTION 10910, ET SEQ.**

Motion by:	Larson	Second by:	Perea
Ayes:	Larson, Perea, Anderson, Poochigian, Case	Noes:	None
Abstentions:	None	Absentees:	0

EXHIBIT "A"

Initial Study Application No. 5409
Classified Conditional Use Permit Application No. 3136
Site Plan Review Application No. 7655
Vesting Tentative Tract Map Application No. 5430

Staff: The Fresno County Planning Commission considered the Subdivision Review Committee Report and Staff Report dated July 17, 2008, and heard a summary presentation by staff, including information presented by the supervisor of the Water-Geology Unit regarding the adequacy of the water supply for the project.

Applicant: The applicant and applicant's representative concurred with the Subdivision Review Committee Report and Staff Report and offered the following points of information:

- We strongly support the staff recommendation for approval of the project. Design of the subdivision is consistent with adopted infrastructure plan as well as approved Specific Plan.
- The infrastructure plan adopted by the Fresno County Board has a standard of 0.55 acre-feet/unit with 10% contingency to be implemented through a dual meter system applicable in Millerton Specific Plan.
- We will accommodate the access easement in the final map.
- For some 20-years a water agreement has been in place between County and Arvin-Edison Water District with an effort to make it firm in past 2-3 years. This water is backed by Lower Tule (Irrigation District) Agreement which is already in place.
- Arvin-Edison approved and signed the water agreement which is up for adoption by the Fresno County Board of Supervisors on July 22, 2008.
- Land in the Millerton Newtown is in the Place of Use. The State Water Resources Control Board confirmed on January of 2007 that water for this project is in the Place of Use.
- Arvin-Edison and Lower Tule Agreements will provide water for both residential and commercial uses. The two districts combined have 400,000 acre-feet of annual water supply.
- The tertiary wastewater treatment plant will recycle water to be used for landscaping and the golf course.
- County will adopt tiered water rates before any water is served to the project which is designed to discourage homeowners from using excessive water.

- A covenant will be recorded on each dwelling unit as a conveyance document which will include instructions on the use of water.

Others: No other individuals presented information in support of the application.

Two individuals presented information expressing concerns with the project related to the loss of a recorded access easement across the subject property to a neighboring parcel and another related to the availability of surface water to this project and that provision of subdivision water should not jeopardize or impact availability of water to other projects in the area.

Correspondence: No letters were presented to the Planning Commission in support of or in opposition to the application.

EXHIBIT "B"

Conditions of Approval

Initial Study Application No. 5409
Classified Conditional Use Permit Application No. 3136

1. Development and operation of the facility shall be in substantial compliance with the site plan and operational statement.
2. All conditions of the Subdivision Review Committee Report for Vesting Tentative Subdivision Map No. 5430 shall be complied with.
3. This permit shall be tied to Vesting Tentative Subdivision Map No. 5430; if the tract is denied or expires, the Conditional Use Permit shall also expire.

NOTE: In accordance with Section 873 – I of the Zoning Ordinance, a conditional use permit to authorize a tentative subdivision map automatically assumes the life span of the tract map.

4. All existing property development standards of R-1(c) and R-1-C (c) Districts listed in the Zoning Ordinance, shall apply except for the following deviations:

Setbacks for lots in R-1(c) Districts:

1. The minimum front and rear yard setbacks will be 10 feet for a structure
(Minimum required: 20 foot front and 20 foot rear)

Setbacks for lots in R-1-C (c) Districts:

1. The minimum front and rear yard setbacks will be 10 feet for a structure
(Minimum required: 25 foot front and 20 foot rear)
2. The minimum side yard setback will be five feet (Minimum required: seven feet).

Parcel configuration for 381 Lots in MSP Residential Development Allocation Area A located in R-1 (c) and R-1-C (c) districts

1. Minimum Lot Area: 6,000 square feet (6,000 – 9,000 square feet required)
2. Interior Lot Width: 60 feet (60-70 feet required)
3. Corner Lot Width: 60 feet (65-80 feet required)

4. Curved/Cul-de-Sac Street Frontage: 35 feet (40-50 feet required)
5. Lot Depth: 100 feet (100-110 feet required)
6. Lot Coverage: 50% maximum (40% maximum allowed)
7. Front Yard: 10 feet (20-25 feet required)
8. Side Yard: 5 feet (5-7 feet required)
9. Street Yard: 10 feet (10-15 feet required)
10. Building height: 35 feet (25-35 feet required)
11. Fencing (front): 3.5 feet (3 feet allowed)
12. Fencing (street side): 3.5 feet (3 feet allowed)

Parcel configuration for 180 Lots (127 Lots in MSP Residential Development Allocation Area A and 53 Lots in Area B located in R-1 (c) district)

1. Minimum Lot Area: 4,500 square feet (6,000 square feet required)
 2. Interior Lot Width: 45 feet (60 feet required)
 3. Corner Lot Width: 55 feet (65 feet required)
 4. Curved/Cul-de-Sac Street Frontage: 35 feet (40 feet required)
 5. Lot Coverage: 60% maximum (40% maximum allowed)
 6. Front Yard: 10 feet (20 feet required)
 7. Side Yard: 4 feet (5 feet required)
 8. Building height: 35 feet (25 feet required)
 9. Fencing (front): 3.5 feet (3 feet allowed)
 10. Fencing (street side): 3.5 feet (3 feet allowed)
5. No on-street parking shall be allowed on private streets and shall be enforced by the Homeowner's Association (HOA) which would include no parking signs, curbs painted red, neighborhood patrol by a private security company or homeowners, citations/fines by HOA and reporting to the sheriff's office.
6. On-street solid waste pick-up shall only be allowed on 35-foot wide private residential streets.

Initial Study Application No. 5409
Site Plan Review Application No. 7655
Vesting Tentative Tract Map Application No. 5430

A. MILLERTON ROAD:

1. Shall be constructed to an Arterial Public road standard as shown in Figure SP1-6 of the Millerton Specific Plan adjacent to the project.
2. A Zone of Benefit in County Service Area 34 or other method acceptable to the Director of the Department of Public Works and Planning shall be provided for the maintenance of the landscape median.

B. MARINA DRIVE (WINCHELL COVE ROAD):

1. Shall be developed as four-lane divided roadway, in a 106-foot right-of-way, through the commercial area. North of the commercial area to the Park Boundary, Marina Drive shall be constructed as a two-lane undivided road in an 84-foot right-of-way with provisions for the future addition of two travel lanes when traffic volumes warrant. Development of Marina shall be in accordance with Figure SP1-7 and policy C.1c(3)e of the Millerton Specific Plan.
2. Left-turn lanes shall be provided on Marina Drive at all intersections.
3. The applicant shall provide a 50-foot wide landscaped setback along both sides of Marina Drive within the boundaries of the proposed subdivision. No structures or advertising signs shall be allowed within the setback, except for temporary real estate or directional signs.
4. Thirty-foot by thirty-foot corner cutoffs shall be provided at all intersections.
5. A Class III bicycle path (Bike Route) shall be provided having a minimum paved width of five feet along each side of the roadway and signed for no on-street parking.

C. ROAD 'A' SOUTH OF ROAD 'M' (SUBRICE AVENUE):

1. Shall be developed as a Collector road in accordance with Figure SP1-8 of the Millerton Specific Plan.
2. Shall provide for relinquishment of direct vehicular access rights to and from Lots as indicated on the tentative map.

D. ROADS 'M' & 'T':

1. Shall be developed as Collector roads in accordance with Figure SP1-8 of the Millerton Specific Plan.
2. Shall provide for relinquishment of direct vehicular access rights to and from Lots as indicated on the tentative map.
3. Shall provide for onsite turnarounds for Lots fronting the roads.

E. INTERIOR ROADS:

1. Shall be constructed to a 25 M.P.H. local residential street standard as shown in Figure SP1-8 of the Millerton Specific Plan. The 25 M.P.H. design speed requires the interior roads to have a minimum centerline curve radius of 230 feet.
2. 20' x 20' corner cutoffs shall be provided at all intersections of all interior roads. Adequate sight distance shall be provided at all intersections based upon a 25-MPH design speed for the interior streets.
3. Shall intersect at approximately 90-degree angles.
4. A County Standard B-2 cul-de-sac shall be provided at the end of all cul-de-sac roads.
5. All cul-de-sac streets in excess of 300 feet in length require a fire hydrant installed at the end of the street.
6. Shall provide for relinquishment of direct vehicular access rights to and from Lots as indicated on the tentative map and Lot 180 for Road A.

F. INTERIOR GATED ROADS:

1. The call box or actuator shall be located a minimum of 25 feet from the public right-of-way.
2. A turnaround shall be provided so that a vehicle which is denied access can exit in a continuous forward motion.
3. The call box or actuator setback from the public right-of-way shall be determined by statistical analysis using the "queuing theory" to ensure that there is a 1% or less chance of a vehicle stopping in the right-of-way due to another vehicle waiting to be granted access to the development. For each gate, the queuing analysis shall use a five minute delay for the peak-hour traffic entering the gate. In the analysis of the 1% failure rate, a Poisson process and the use of Poisson distribution cumulative terms will be considered an acceptable approximation. In addition, each vehicle shall be given a 25 foot envelope in determining the right-of-way setback.
4. If a by pass lane with a separate call box or actuator is provided for the residents, these vehicles may be deducted from the analysis. This is assumed to be 90% of the peak-hour traffic.
5. The gate at Road Y shall be for emergency ingress and egress only.
6. The modified 35-foot and 30-foot private local residential street shall be constructed to a 15 M.P.H. design speed private road in accordance with County Improvement Standard A-18 (26 feet of base and pavement with concrete curb and gutter) except that roads serving less than six lots may be developed in accordance with the A-18a Standard. These standards shall be complied with as modified by Conditional Use Permit No. 3136 allowing on-street solid waste pick-ups on 35-foot wide private residential streets.

7. 20' x 20' corner cutoffs shall be provided at all intersections of all interior roads. Adequate sight distance shall be provided at all intersections based upon a 25 M.P.H design speed for the interior streets.
8. Shall intersect at approximately 90-degree angles.
9. Shall be contained within non-exclusive private road easements or outlots for the same purpose.
10. A Homeowners Association or other method acceptable to the Director of the Department of Public Works and Planning shall be provided for the maintenance of the private roads, parking and landscaped areas and gates.
11. The subdivider will be required to secure the maintenance of the private roads for a period of two years after the acceptance thereof.

G. ROADS GENERAL:

1. Street and regulatory signs and markings shall be included in the design in accordance with County Standards.
2. Engineered plans for the road improvements shall be submitted to the County of Fresno for review and approval. The initial submittal shall include a soils report which shall identify a recommended traffic index, R-value, and pavement structural section. If significant cuts and fills are involved, subsequent R-values shall be obtained for sub-grade after completion of earthwork operations.
3. Direct access to each lot shall be certified by a licensed civil engineer.

H. DRAINAGE AND EROSION CONTROL:

1. Provisions shall be made to maintain natural drainage throughout the development in a manner that will not significantly change the existing drainage characteristics of those parcels adjacent to the development.
2. Additional runoff generated by the development including full residential build-out of the subdivision shall be retained on-site within drainage ponds or approved pipe storage systems or other facilities acceptable to the Director of the Department of Public Works & Planning. Fresno County shall review and approve the Grading and Drainage Plan for the project.
3. A drainage study inclusive of both hydrology specific to the area (Rational method will most likely not be appropriate due to excessive topography) and hydraulics will be needed to determine sizes and locations of culverts and/or relocated drainage channels.
4. Proposed basins in excess of eighteen inches in depth shall be fenced. Type of fencing shall be chain link or other form that would discourage public access.

5. If natural drainage swales are piped or rerouted, easements for the pipelines and/or channels and a maintenance organization to maintain them will be required. Said work will require that the applicant obtain a Stream Bed Alteration Agreement with the State Department of Fish and Game, and/or a Section 404 Permit from the US Army Corps of Engineers.
6. Liberal drainage easements and building setbacks shall be provided for all natural watercourses.
7. The centerline of all natural watercourses, dimensioned at the lot lines, shall be indicated on an additional map sheet.
8. The applicant shall obtain an NPDES permit prior to construction or grading activities. A Notice of Intent [NOI] shall be filed with the Regional Water Quality Control Board. A copy of this Notice shall be provided to the County prior to commencement of any grading activities.
9. The applicant shall develop a Storm Water Pollution Prevention Plan (SWPPP) and incorporate the plan into the construction improvement plans. The plan shall be submitted to the County prior to commencement of any grading activities.
10. Design of individual building pads with specific areas of grading for each lot shall be provided as part of the drainage improvement plans submitted for this development.

I. MAINTENANCE:

1. A Zone of Benefit in County Service Area 34 or other method acceptable to the Director of the Department of Public Works and Planning shall be provided for the maintenance of the new roads lying outside the gated area.
2. The subdivider will be required to secure the maintenance of the new roads for a period of two years after the acceptance thereof.

J. FIRE PROTECTION:

1. The design of the fire protection water system with location and number of fire hydrants together with the size of the water mains shall conform to County Standards and shall be approved by the Director of Public Works after consideration of the recommendations of the fire district having jurisdiction of the area.

K. WATER SERVICE:

1. The applicant's engineer shall provide a design for all elements of the system to the County for review and approval.

2. All proposed water facilities improvements shall be constructed in accordance with Fresno County Improvement Standards.

L. SEWER SERVICE:

1. The applicant's engineer shall provide a design for all elements of the system to the County for review and approval.
2. All proposed sewer facilities improvements shall be constructed in accordance with Fresno County Improvement Standards.

M. STREET NAMES:

1. The internal roads within the subdivision shall be named. The subdivider shall obtain approval of names from the Street Names Committee prior to the final map approval.

N. EMERGENCY ACCESS ROADS:

1. Shall be contained within emergency access easements and improved to a standard to provide traversability for emergency equipment as determined by the Director of the Department of Public Works and Planning after consideration of the recommendations of the fire district having jurisdiction of the area. Crash gates shall be provided at the end of the easements.

O. SOILS:

1. A soils investigation report prepared in accordance with the County's Improvement Standards (Section II-H) shall be required with the submittal of the final map.

P. OUTLOTS:

1. The use of all Outlots shall be designated on the recorded map.
2. Ownership of all outlots shall be by CSA 34 for the benefit of all owners, as an undivided interest by all the lot owners, or by other method approved by the Director. No outlot shall be developed, except as allowed by the Fresno County Zoning Ordinance, nor shall any outlot be divided or be encumbered by a mortgage or other lien as security for a debt without the prior written consent of the Board of Supervisors, and 66-2/3 percent of the owners and mortgages. The County is the intended beneficiary of this provision and shall have the right to enforce this provision by all available remedies, legal and equitable. This condition shall be included in a recorded covenant to run with the land.

Q. OTHER CONDITIONS:

1. All conditions of Classified Conditional Use Permit Application No. 3136 shall be complied with.

2. Prior to recordation of the final map, a zone of benefit within County Service Area 34 shall be established for the project.
3. The project shall comply with all the applicable provisions of Specific Plan related to Land Use, Transportation, Housing, Environmental Resources Management, Public facilities, Community Design Elements and implementation.
4. Pursuant to Specific Plan, Section F. 4, F.4c (4), a pedestrian grade separated crossing or area for other suitable access features shall be provided.
5. Prior to recordation of the final map, an agreement between the developer and the CSA shall be entered in which the developer is responsible for all costs associated with the operation, maintenance, and administration of the CSA until such time as these costs can be met by the CSA through assessments or fees. This agreement shall be recorded.
6. Prior to recordation of the final map, all services proposed to be provided by the CSA, the level of each service and the proposed rate of each service shall be identified in a Service Plan prepared by an engineer. In the case of the provision of water and sewer services an analysis, certified by an engineer, shall be provided demonstrating adequacy of infrastructure for these services. Said analysis shall contain data no older than six (6) months prior to recordation.

NOTE: In order to discourage the over use of water, a tiered rate structure must be included for review and approval. The tiered rate structure must be significantly tiered to encourage water conservation.

7. Prior to recordation of the final map, the tiered rate structures for the use of water for domestic and landscape/irrigation purposes shall be submitted for review and approval. The tiered rate structure for landscape/irrigation water shall be significantly tiered to discourage over-use of landscape/irrigation water and shall also outline when the landscape/irrigation water shall be disconnected and the procedures to be implemented for disconnection and enforcement.
8. Prior to recordation of the final map, a preliminary budget shall be completed for the operation and maintenance of the CSA including contingencies and reserves. An estimate of these costs shall be prepared by the developer's engineer and will be subject to review by the County.
9. The water and wastewater facilities shall be designed and constructed in accordance with the approved Infrastructure Plans.
10. An Infrastructure Plan for water, sewer, and drainage that addresses the policies in Sections 806-07:5.01, 5.02, 5.03, and 5.04 of the Millerton Specific Plan, together with the terms of the Use and Allocation of Capacities and Reimbursement Agreement dated January 29, 1991, shall be adopted by Fresno County prior to approval of a Final Map. Prior to issuance of any building permit, all appropriate infrastructures required for this project by the approved Infrastructure plan including the wastewater and water facilities shall be completed and accepted by the Resources Division of the Department of Public Works and Planning.

11. All rights to groundwater beneath the subdivision shall be dedicated to the County Service Area subject to development by the subdivider or his assignee.
12. All mitigation measures listed in the Mitigation Measures and Monitoring Program Matrix for the Millerton Specific Plan EIR (Exhibit 7) that are applicable to the proposed development shall be complied with unless the Fresno County Ordinance Code or Improvement Standards requires a higher standard, in which case the higher standard shall be met. Prior to any development, the applicant shall enter into an agreement with Fresno County for the purpose of reimbursing the County for all costs incurred by the County in complying with the mitigation and monitoring requirements of CEQA (Public Resources Code Section 21081.6). These costs shall include, but are not limited to, staff and consultant services.
13. Prior to the recording of final map, the applicant shall provide acoustical analysis for review and approval by the Fresno County Department of Public Health, Environmental Health Division, and its findings related to noise attenuation will be incorporated into the final map.
- *14. All outdoor lighting shall be hooded and directed so as not to shine toward public roads or the surrounding properties.
- *15. The applicant shall comply with the Endangered Species Act. The applicant shall complete and submit a Biological Assessment and resulting Biological Opinion acceptable to the United States Fish and Wildlife Service which shall include Mitigation and Avoidance Measures for plants and animals.
- *16. In the event that cultural resources are unearthed during grading or construction activity, all work shall be halted in the area of the find, and an archeologist shall be called to evaluate the findings and make any necessary mitigation recommendations. If human remains are unearthed during construction, no further disturbance is to occur until the Fresno County Coroner has made the necessary findings as to origin and disposition. If such remains are Native American, the Coroner must notify the Native American Commission within 24 hours.
- *17. Prior to recordation of a final map, a funding mechanism shall be established through a community facilities district or districts under the Mello-Roos Community Facilities Act of 1982, or other appropriate funding mechanism to be determined by the County, to support cost for Sheriff's protection services to achieve a ratio of 2.0 sworn officers per 1,000 residents for the affected properties. In addition, the project proponents shall pay for any cost associated with the establishment of the referenced funding mechanism.
- *18. To mitigate potential impacts to the County maintained roads, a pro-rata share for future off-site improvements is required as defined in item a and b below. This fee shall either be paid prior to recordation of the map or a covenant shall be recorded on each lot providing notice that issuance of a building permit is subject to payment of a Public Facilities fee. If the applicant opts for the latter, the fee shall be collected no later than the date of final inspection or the date of issuance of a certificate of occupancy, whichever comes first.
 - a. Signalization at the intersection of Friant Road and Willow Avenue. The project's maximum share for the 2025 scenario is 4.12 % or \$17,245.00.

- b. Signalization at the intersection of Friant and North Fork Roads. The project's maximum share for the 2025 scenario is 3.92 % or \$16,431.00.
- c. Signalization at the intersection of Willow and Copper Avenues. The project's maximum share for the 2025 scenario is 1.44 % or \$6,036.00.
- d. Signalization at the intersection of Millerton and Auberry Roads. The project's maximum share for the 2025 scenario is 1.04 % or \$4,358.00.
- e. Signalization at the intersection of Millerton Road and Sky Harbor Drive. The project's maximum share for the 2025 scenario is 2.35 % or \$9,825.00.
- f. Signalization at the intersection of Millerton and Brighton Crest Roads. The project's maximum share for the 2025 scenario is 2.63 % or \$11,025.00.
- g. Signalization at the intersection of Millerton Road and Marina Drive. The project's maximum share for the 2025 scenario is 9.26 % or \$38,791.00.
- h. Signalization at the intersection of Auberry Road and Copper Avenue. The project's maximum share for the 2025 scenario is 3.49 % or \$14,624.00.
- i. Signalization at the intersection of Auberry Road and Winchell Cove Road/Marina Drive. The project's maximum share for the 2025 scenario is 5.49 % or \$22,976.00.
- j. Road widening from two (2) lanes to four (4) lanes arterial of 1.2 miles of Friant Road from Lost Lake Park Road to North Fork Road. The project's maximum share for the 2025 scenario is 4.15% or \$145,127.00.
- k. Road widening from two (2) lanes to four (4) lanes arterial of 3.3 miles of Millerton Road from North Fork Road to Marina Drive. The project's maximum share for the 2025 scenario is 5.45% or \$ 1,485,890.00.
- l. Road widening from two (2) lanes to four (4) lanes of one-mile of Millerton Road from Marina Drive to Sky Harbor Road. The project's maximum share for the 2025 scenario is 2.91% or \$ 240,580.00.
- m. Road widening from two (2) lanes to four (4) lanes of 2.2 miles of Millerton Road from Sky Harbor Road to Auberry Road. The project's maximum share for the 2025 scenario is 3.58% or \$ 650,184.00.
- n. Friant Kern Canal Bridge improvement on Millerton Road [two (2) to four (4) lanes]. The project's maximum share for the 2025 scenario is 5.45% or \$170,415.00.
- o. Road widening from two (2) lanes to four (4) lanes of 1.85 miles of Willow Avenue from Friant Road to Copper Avenue. The project's maximum share for the 2025 scenario is 0.90% or \$ 59,519.00.

- p. Road widening from two (2) lanes to four (4) lanes of 5.5 miles of Auberry Road from Copper Avenue to Winchell Cove Road/Marina Drive. The project's maximum share for the 2025 scenario is 5.02% or \$ 981,114.00.

The above represents per lot cost of \$ 6,906.00 (a total of \$ 3,874,140.00 for 561 lots). The County shall update cost estimates for the above specified improvements prior to execution of the agreement. The Board of Supervisors pursuant to Ordinance Code Section 17.88 shall adopt a Public Facilities Fee addressing the updated pro-rata costs. The Public Facilities Fee shall be related to off-site road improvements, plus costs required for inflation based on the Engineering New Record (ENR) 20 Cities Construction Cost Index.

- 19. All complete information to obtain/amend a water system permit shall be provided to county staff prior to the issuance of building permits.

* MITIGATION MEASURE – Measures specifically applied to the project to mitigate potential adverse environmental effects identified in the environmental document. A change in the condition may affect the validity of the current environmental document, and a new or amended environmental document may be required.



Bernard Jimenez, Director
Planning Department
County of Fresno
2220 Tulare Street, 6th Floor
Fresno, Calif. 93721

Subject: Request for "Time Extension" of Tentative Tract No. 5430

Dear Mr. Jimenez,

This is a request for a "Time Extension" of the life of Tentative Tract No. 5430 within the Millerton Specific Plan area. It is our understanding that this map so set to expire on 04-13-2021.

We are requesting this extension of time to allow us to create a new overall "Infrastructure Plan" for lands within the Millerton Specific Plan. Also, due to very recent additional property acquisitions within the southern end of the Specific Plan area by our companies, we are preparing a "Phasing Plan" that will provide the County with the proposed sequence of development. Having this extension will help us with future planning for the entire area.

Please feel free to contact me if you have any questions. Thank you for your assistance.

A handwritten signature in black ink, appearing to read "Jeffrey T. Roberts", is written over the ASSEMI GROUP logo.
The ASSEMI GROUP logo, consisting of a stylized blue triangle and the text "ASSEMI GROUP".

Jeffrey T. Roberts | Entitlement Director

T: [\(559\) 440-8308](tel:5594408308) | M: [\(559\)288-0688](tel:5592880688) | F: [\(559\) 436-1659](tel:5594361659) | X:308

E: jroberts@assemigroup.com

W: www.assemigroup.com

1396 W. Herndon Ave., Ste. 110, Fresno, CA 93711