

SPECIFICATIONS

BITUMINOUS SEAL COATS

VARIOUS LOCATIONS IN FRESNO COUNTY

BUDGET / ACCOUNT: 4510 / 7370



Department of Public Works and Planning

CONTRACT NUMBER 20-14-M

T A B L E O F C O N T E N T S

COVER SHEET

BOARD ADOPTION AND ACKNOWLEDGMENT

Engineer's Signature

NOTICE TO BIDDERS

BID ITEMS AND APPLICABLE SECTIONS

SPECIAL PROVISIONS

PROJECT DETAILS / DRAWINGS

Project Drawings/Details
Self-Dealing Transactions Disclosure Form
Revised Standard Specifications Dated 09-02-16

BID BOOK

Bidder's Declaration
Bid Form
Abbreviations Used
Signature Page
Noncollusion Declaration
Public Contract Code
Subcontractor List
Certifications
Guaranty
Opt-Out of Asphalt Concrete Price Fluctuations Form

AGREEMENT

**2020-2021 BITUMINOUS SEAL COATS
CONTRACT NUMBER: 20-14-M**

Steve Brandau, Chairman	2nd District
Brian Pacheco, Vice Chairman	1st District
Sal Quintero	3rd District
Ernest Buddy Mendes	4th District
Nathan Magsig	5th District

Jean Rousseau, County Administrative Officer

Steven E. White, Director
Department of Public Works and Planning



Date Signed: 2/9/2021

Supervising Engineer: _____

A handwritten signature in blue ink that reads "Joe Harrell". Below the signature is a small printed name "Joseph C. Harrell, P.E.".

Joseph C. Harrell, PE C80424
Lic. Expiration: 3/31/23

FRESNO COUNTY
Department of Public Works and Planning
m/a 2220 Tulare Street, Suite 720
Fresno, CA 93721-2106

BOARD OF SUPERVISORS COUNTY OF FRESNO STATE OF CALIFORNIA

NOTICE TO BIDDERS

Sealed proposals will be received at:

<https://www.bidexpress.com/businesses/36473/home>

and at the Fresno County Department of Public Works and Planning (Department), Office of the Design Engineer, Seventh Floor, Fresno County Plaza Building, 2220 Tulare Street, Fresno, CA 93721 until

**2:00 P.M., (1400 hours and 00 seconds)
Thursday, March 11, 2021**

Due to the COVID-19 restrictions and guidelines, the Department's bid reception desk is closed and all bidders are encouraged submit bids online through Bid Express.

If a bidder is unable to submit online through Bid Express, please make arrangements to submit your bid in person or by mail by e-mailing DesignServices@fresnocountyca.gov or calling (559) 600-9908.

Promptly following the closing of the bidding all timely submitted bids will be publicly opened and viewable via a livestream (the link for which will be posted at <http://www.co.fresno.ca.us/planholders>) for construction in accordance with the project specifications therefor, to which special reference is made as follows:

BITUMINOUS SEAL COATS

VARIOUS LOCATIONS IN FRESNO COUNTY

CONTRACT NUMBER 20-14-M

The work to be done consists, in general, of furnishing and placing screenings over asphaltic emulsion at various existing roads in Fresno County. The seal coat will be constructed on 29.618 miles of roadway on County roads. County forces will repair, trim, and blade heavy dirt deposits and vegetation from the existing surfacing in advance of construction.

A pre-bid conference will be held at 1:00 p.m., on February 23, 2021. A discussion of the project will be held and the project sites will be open for examination. Contractors should meet at the intersection of Pepperweed Rd and Squaw Valley Rd. Attendance at the pre-bid is not mandatory; however, the scheduled pre-bid will be the only opportunity for prospective bidders to visit the site in the presence of County staff, and requests for individual site visits with County staff will not be granted.

The County of Fresno is committed to increasing the availability of employment and training opportunities, and requires that the Contractor and each subcontractor employed on this Project shall use their best efforts to ensure that thirty-three percent (33%) of apprentice hours are performed by qualified participants in state approved apprenticeship programs who also are current or former "Welfare-to-Work" participants in the CalWORKs program. Attention is directed to "Apprentices" in Section 7 of these special provisions.

Incentives whereby the Contractor or subcontractor receives partial reimbursement for the wages paid to apprentices who qualify may be available. The incentive program is administered by the County of Fresno, Department of Social Services, Employment

Resource Center. For questions regarding the incentive program, contact the Employment Resource Center at (559) 600-5370.

Bidders may fill out a Request to be Added to Planholders list:

<https://www.co.fresno.ca.us/departments/public-works-planning/divisions-of-public-works-and-planning/design-division/planholders-list-request-to-be-added>

Requesters will then be listed as a planholder for the project on the website and receive notifications and addenda issued for the project.

Prospective bidders may also select the project on www.BidExpress.com. Those that demonstrate interest in the project will be added to the planholders list, and receive notifications and addenda issued for the project.

Planholder and exchange/publication names may be obtained from the Fresno County website at <http://www.co.fresno.ca.us/planholders>.

Electronic copies, in “.pdf” file format, of the official project specifications, bid books and proposal sheets, such additional supplemental project information as may be provided, are available to view, download, and print at <http://www.co.fresno.ca.us/planholders>.

If a bidder is unable to submit a bid via Bid Express, Bid Books, which contain bid proposal sheets necessary to submit a bid, may be obtained within the Specifications documents posted on the Fresno County website.

Electronic bids shall be submitted via the BidExpress website. Hardcopy bids shall be submitted in a sealed envelope addressed to the Department and labeled with the name of the bidder, the name of the project and the statement “Do Not Open Until The Time Of Bid Opening.”

Bid security in the amount of ten (10) percent of the amount of the bid, and in the form of a bid bond issued by an admitted surety insurer licensed by the California Department of Insurance, cash, cashier's check or certified check shall accompany the bid. You must either attach an electronic bid bond or provide an original bid bond (or other form of bid security authorized by Public Contract Code Section 20129(a)), prior to the bid opening. Bid security shall be made in favor of the County of Fresno.

Hardcopy bid bonds shall be submitted in a sealed envelope addressed to the Department and labeled with the name of the bidder, the name of the project and the statement “Do Not Open Until The Time Of Bid Opening – BID BOND”

A Summary of Bids and a list of subcontractors for the apparent low bidder will be posted at the above listed website, generally within 24 hours of the Bid Opening.

All questions regarding this project shall be in writing and shall be received by the Department of Public Works and Planning, Design Division, no later than 2:00 P.M. on the seventh (7th) calendar day before bid opening. Any questions received after this deadline will not receive a response unless the Department of Public Works and Planning elects to issue an addendum to revise the bid opening date. In the event that the bid opening date is revised, the deadline for questions will be extended to no later than 2:00 P.M. on the seventh (7th) calendar day before the revised bid opening date. Questions shall be submitted on the “Request for Clarification Form” provided on our website:

<http://www.co.fresno.ca.us/departments/public-works-and-planning/construction-bidding-opportunities/20-14-m-bituminous-seal-coats/20-14-m-request-for-clarification-form>

Any changes to, or clarification of, the project plans and specifications shall be in the form of a written addendum issued to planholders of record. Questions that prompt a change or clarification shall be included in the addendum with the subsequent answer.

Any oral explanation or interpretations given to this project are not binding.

No contract will be awarded to a contractor who has not been licensed in accordance with the provisions of the Contractors State License Law, California Business and Professions Code, Division 3, Chapter 9, as amended, or whose bid is not on the proposal form included in the contract document. A valid California Contractor's License, **Class A (General Engineering) or Class C-12 (Earthwork and Paving)** is required for this project.

Pursuant to Section 1773 of the Labor Code, the general prevailing wage rates in the county, or counties, in which the work is to be done have been determined by the Director of the California Department of Industrial Relations. These wages are set forth in the General Prevailing Wage Rates for this project, available at County of Fresno, Department of Public Works and Planning, 2220 Tulare Street, Sixth Floor, Fresno CA 93721-2104 and available from the California Department of Industrial Relations' Internet web site at <http://www.dir.ca.gov/DLSR/PWD>. Future effective general prevailing wage rates, which have been predetermined and are on file with the California Department of Industrial Relations are referenced but not printed in the general prevailing wage rates.

This project is subject to compliance monitoring and enforcement by the Department of Industrial Relations.

No contractor or subcontractor may be listed on a bid proposal for a public works project unless registered with the Department of Industrial Relations pursuant to Labor Code section 1725.5 [with limited exceptions from this requirement for bid purposes only under Labor Code section 1771.1(a)].

No contractor or subcontractor may be awarded a contract for public work on a public works project unless registered with the Department of Industrial Relations pursuant to Labor Code section 1725.5.

This contract is subject to state contract nondiscrimination and compliance requirements pursuant to Government Code, Section 12990.

Bids are required for the entire work described herein. Bids will be compared on the basis of the cumulative sum of the bid amounts listed for the individual line items.

The successful bidder shall furnish a faithful performance bond in the amount of 100 percent of the contract amount and a payment bond in the amount of 100 percent of the contract amount. Each bond specified in this Notice (bid bond, faithful performance bond and payment bond) shall meet the requirements of all applicable statutes, including but not limited to those specified in Public Contract Code section 20129 and Civil Code section 3248.

Each bond specified in this Notice shall be issued by a surety company designated as an admitted surety insurer in good standing with and authorized to transact business in this state by the California Department of Insurance, and acceptable to the County of Fresno. Bidders are cautioned that representations made by surety companies will be verified with the California Department of

Insurance. Additionally, the County of Fresno, in its discretion, when determining the sufficiency of a proposed surety company, may require the surety company to provide additional information supported by documentation. The County generally requires such information and documentation whenever the proposed surety company has either a Best's Key Rating Guide of less than **A** and a financial size designation of less than **VIII**. Provided, however, that the County expressly reserves its right to require all information and documentation to which the County is legally entitled from any proposed surety company.

Pursuant to Public Contract Code Section 22300, substitution of securities for any moneys withheld by the County of Fresno to ensure performance under the contract shall be permitted.

The Board of Supervisors reserves the right to reject any or all bids.

Board of Supervisors, County of Fresno

Jean Rousseau, County Administrative Officer

Bernice E. Seidel, Clerk to the Board

Issue Date: February 9, 2021

Bid Items and Applicable Sections

**BITUMINOUS SEAL COATS
VARIOUS LOCATIONS IN FRESNO COUNTY
CONTRACT NO. 20-14-M**

Bid Items and Applicable Sections

ITEM NO	ITEM DESCRIPTION	UNIT	SECTION
-	SUPPLEMENTAL WORK	\$	-
090020A	SUPPLEMENTALWORK (PAYMENT ADJUSTMENTS FOR PRICE INDEX FLUCTUATION)	\$	9
120100	TRAFFIC CONTROL SYSTEM	LS	12
130100	JOB SITE MANAGEMENT	LS	13
130570	TEMPORARY COVER	SQYD	13
130200	PREPARE WATER POLLUTION CONTROL PROGRAM	LS	13
130620	TEMPORARY DRAINAGE INLET PROTECTION	EA	13
370001	SAND COVER	TON	37
374493	POLYMER ASPHALTIC EMULSION (SEAL COAT)	TON	37
375001	SCREENINGS (3/8")	TON	37
374004	ASPHALTIC EMULSION (FLUSH COAT)	TON	37
810230	PAVEMENT MARKER (RETROREFLECTIVE)	EA	81
840656	PAINT TRAFFIC STRIPE (2-COAT)	LF	84
840666	PAINT PAVEMENT MARKING (2-COAT)	LF	84
840501	THERMOPLASTIC TRAFFIC STRIPE (SPRAYABLE)	LF	84
840515	THERMOPLASTIC PAVEMENT MARKING	SF	84
846030	REMOVE THERMOPLASTIC TRAFFIC STRIPE	LF	84
846035	REMOVE THERMOPLASTIC PAVEMENT MARKING	SF	84
999990	MOBILIZATION	LS	9

Special Provisions

DIVISION I GENERAL PROVISIONS
1 GENERAL

1-1.01 GENERAL

Add to the beginning of Section 1:

The work is done in accordance with the 2015 *Standard Specifications*, 2015 *Standard Plans* and the following special provisions.

Where these special provisions indicate to replace, add to, delete, delete from, or otherwise modify a "section," or a portion thereof, the section or portion thereof to which such modification is to be applied is the section or portion thereof with the corresponding numbering in the 2015 *Standard Specifications*.

Except to the extent that they may conflict with these special provisions, revised standard specifications apply if included in the project details section of the book entitled "Specifications."

Revised standard plans apply if listed on the "List of Revised Standard Plans," if any, in these special provisions; or if shown or referenced on the project plans or in the project details section of the book entitled "Specifications."

In case of conflict between the *Standard Specifications* and these special provisions, the special provisions shall take precedence over and be used in lieu of such conflicting portions.

In case of conflict between applicable revised standard specifications and these special provisions, the special provisions shall take precedence over and be used in lieu of such conflicting portions.

Add to the end of section 1-1.01:

Bid Items and Applicable Sections

Item Code	Item description	Applicable Section
090010A	SUPPLEMENTAL WORK	9
090020A	SUPPLEMENTAL WORK (PAYMENT ADJUSTEMENT FOR PRICE INDEX FLUCTUATIONS)	9

Add to the 1st table of section 1-1.06:

SJVAPCD	San Joaquin Valley air pollution control district
AQMD	air quality management district
CISS	cast-in-steel shell
CSL	crosshole sonic logging
GGL	gamma-gamma logging
METS	Caltrans Material Engineering and Testing Services

Add to section 1-1.06:

Abbreviations in the Bid Item List are also used in Proposal 2 Bid Item List.

Replace Section 1-1.07 with:

1-1.07 DEFINITIONS

1-1.07A General

Interpret terms as defined in the Contract documents.

1-1.07B Glossary

abandon: Render unserviceable in place.

acts of God: *Acts of God* as defined in Pub Cont Code § 7105.

activity: Task, event, or other project element on a schedule that contributes to completing the project. An activity has a description, start date, finish date, duration, and one or more logic ties.

adjust: Raise or lower a facility to match a new grade line.

aerially deposited lead: Lead primarily from vehicle emissions deposited within unpaved areas or formerly unpaved areas.

Authorized Facility Audit List: Caltrans-developed list of facilities. For the Authorized Facility Audit List, go to the METS website.

authorized laboratory: Independent testing laboratory (1) not employed or compensated by any subcontractor or subcontractor's affiliate providing other services for the Contract and (2) authorized by the Department.

Authorized Material List: Caltrans-developed list of authorized materials. For the Authorized Material List go to the METS website.

Authorized Material Source List: Caltrans-developed list of authorized source materials. For the Authorized Material Source List go to the METS website.

base: Layer of specified material of planned thickness placed immediately below the pavement or surfacing.

basement material: Material in an excavation or embankment under the lowest layer to be placed.

bid item: Work unit for which the Bidder provides a price.

Bid Item List: List of bid items, units of measure, and the associated quantities. The verified Bid Item List is the Bid Item List with verified prices. The Contract Proposal (Proposal 2) of Low Bidder at the Department's website is the verified Bid Item List. After contract award, interpret a reference to the Bid Item List as a reference to the verified Bid Item List.

borrow: Fill acquired from an excavation source outside the described cut area.

1. **local borrow:** Material obtained by widening cuts or excavating from sources outside the planned or authorized cross section on the job site. The location of the local borrow is described or designated by the Engineer.
2. **imported borrow:** Borrow that is not local borrow.

bridge: Structure that:

1. Has a bridge number
2. Carries a (1) utility, (2) railroad, or (3) vehicle, pedestrian, or other traffic over, under, or around obstructions or waterways

building-construction contract: Contract that has *Building Construction* on the cover of the *Notice to Bidders and Special Provisions*.

California Test: Caltrans-developed test for determining work quality. For California Tests, go to the METS website.

Caltrans: State of California Department of Transportation

certificate of compliance: Certificate stating the material complies with the Contract.

Certified Industrial Hygienist: Industrial hygienist certified in comprehensive practice by the American Board of Industrial Hygiene.

change order work: Work described in a Change Order, including extra work and work described in the Contract as change order work.

closure: Closure of a traffic lane or lanes, including shoulder, ramp, or connector lanes, within a single traffic control system.

commercial quality: Quality meeting the best general practices.

commercial source: Established business operating as a material source for the general public.

Contract: Written and executed contract between the Department and the Contractor.

Contract acceptance: Director's written acceptance of a completed Contract.

Contract time: Number of original working days as adjusted by any time adjustment.

Contractor: Person or business or its legal representative entering into a Contract with the Department for performance of the work.

controlling activity: Construction activity that will extend the scheduled completion date if delayed.

County: The County of Fresno

critical path: Longest continuous chain of activities for the project that has the least amount of total float of all chains. In general, a delay on the critical path extends the scheduled completion date.

critical path method: Network-based planning technique using activity durations and relationships between activities to calculate a schedule for the entire project.

culvert: Structure other than a bridge that provides an opening under a roadway.

data date: Day after the date through which a schedule is current. Everything occurring earlier than the data date is as-built and everything on or after the data date is planned.

day: 24 consecutive hours running from midnight to midnight; calendar day.

1. **business day:** Day on the calendar except a Saturday and a holiday.
2. **working day:** Time measure unit for work progress. A working day is any 24-consecutive-hour period except:
 - 2.1. Saturday and a holiday.
 - 2.2. Day during which you cannot perform work on the controlling activity for at least 50 percent of the scheduled work shift with at least 50 percent of the scheduled labor and equipment due to any of the following:
 - 2.2.1. Adverse weather-related conditions.
 - 2.2.2. Traffic maintenance under the Contract.
 - 2.2.3. Suspension of a controlling activity that you and the Engineer agree benefits both parties.
 - 2.2.4. Unanticipated event not caused by either party, such as:
 - 2.2.4.1. Act of God
 - 2.2.4.2. Act of a public enemy.
 - 2.2.4.3. Epidemic.
 - 2.2.4.4. Fire.
 - 2.2.4.5. Flood.
 - 2.2.4.6. Governor-declared state of emergency.
 - 2.2.4.7. Landslide.
 - 2.2.4.8. Quarantine restriction.
 - 2.2.5. Issue involving a third party, including:
 - 2.2.5.1. Industry or area-wide labor strike.
 - 2.2.5.2. Material shortage.
 - 2.2.5.3. Freight embargo.

- 2.2.5.4. Jurisdictional requirement of a law enforcement agency.
- 2.2.5.5. Workforce labor dispute of a utility or nonhighway facility owner resulting in a nonhighway facility rearrangement not described and not solely for the Contractor's convenience. Rearrangement of a nonhighway facility includes installation, relocation, alteration, or removal of the facility.
- 2.3. Day during a concurrent delay.
- 3. **original working days:**
 - 3.1. Working days to complete the work shown on the *Notice to Bidders* for a non-cost-plus-time-based bid
 - 3.2. Working days bid to complete the work for a cost-plus-time-based bid

Where working days is specified without the modifier *original* in the context of the number of working days to complete the work, interpret the number as the number of original working days as adjusted by any time adjustment.

deduction: Money permanently taken from a progress payment or the final payment. Deductions are cumulative and are not retentions under Pub Cont Code § 7107.

delay: Event that extends the completion of an activity.

- 1. **excusable delay:** Delay caused by the Department and not reasonably foreseeable when the work began, such as:
 - 1.1. Change in the work
 - 1.2. Department action that is not part of the Contract
 - 1.3. Presence of an underground utility main not described in the Contract or in a location substantially different from that specified
 - 1.4. Described facility rearrangement not rearranged as described, by the utility owner by the date specified, unless the rearrangement is solely for the Contractor's convenience
 - 1.5. Department's failure to obtain timely access to the right-of-way
 - 1.6. Department's failure to review a submittal or provide notification in the time specified
- 2. **critical delay:** Excusable delay that extends the scheduled completion date
- 3. **concurrent delay:** Occurrence of at least 2 of the following events in the same period of time, either partially or entirely:
 - 3.1. Critical delay
 - 3.2. Delay to a controlling activity caused by you
 - 3.3. Non-working day

Department: The Fresno County Board of Supervisors and its authorized representatives.

District Office: County of Fresno Department of Public Works and Planning

detour: Temporary route for traffic around a closed road part. A passageway through a job site is not a detour.

Director: Department's Chairman

disadvantaged business enterprise: Disadvantaged business enterprise as defined in 49 CFR 26.5.

dispose of: Remove from the job site.

divided highway: Highway with separated traveled ways for traffic, generally in opposite directions.

Engineer: The County's Director of Public Works and Planning, acting through their authorized designees.

early completion time: Difference in time between an early scheduled completion date and the work completion date.

environmentally sensitive area: Area within or near construction limits where access is prohibited or limited to protect environmental resources.

estimated cost: Estimated cost of the project as shown on the *Notice to Bidders*.

extra work: Any work, desired or performed, but not included in the original Contract.

federal-aid contract: Contract that has a federal-aid project number on the cover of the *Specifications*.

final pay item: Bid item whose quantity shown on the Bid Item List is the quantity paid.

finished grade: Final surface of the completed facility. If the work under the Contract includes stage construction, the relation between the finished grade and the work under the Contract is shown.

fixed cost: Labor, material, or equipment cost directly incurred by the Contractor as a result of performing or supplying a particular bid item that remains constant regardless of the item's quantity.

float: Difference between the earliest and latest allowable start or finish times for an activity.

1. **Department-owned float:** Time saved on the critical path by actions of the Department. It is the last activity shown on the schedule before the scheduled completion date.

force account work: Work ordered on a construction project without an existing agreement on its cost, and performed with the understanding that the contractor will bill the owner according to the cost of labor, materials, and equipment, plus a certain percentage for overhead and profit.

grading plane: Basement material surface on which the lowest layer of subbase, base, pavement, surfacing, or other specified layer is placed.

highway: Whole right-of-way or area reserved for use in constructing the roadway and its appurtenances.

holiday: Holiday shown in the following table:

Holidays	
Holiday	Date observed
Every Sunday	Every Sunday
New Year's Day	January 1 st
Birthday of Martin Luther King, Jr.	3rd Monday in January
Presidents' Day	3rd Monday in February
Cesar Chavez Day	March 31 st
Memorial Day	Last Monday in May
Independence Day	July 4 th
Labor Day	1st Monday in September
Veterans Day	November 11 th
Thanksgiving Day	4th Thursday in November
Day after Thanksgiving Day	Day after Thanksgiving Day
Christmas Day	December 25 th

If January 1st, March 31st, July 4th, November 11th, or December 25th fall on a Sunday, the Monday following is a holiday. If January 1st, March 31st, July 4th, November 11th, or December 25th fall on a Saturday, the preceding Friday is a holiday.

hours of darkness: Hours of darkness as defined in Veh Code § 280.

idle equipment: Equipment:

1. On the job site at the start of a delay
2. Idled because of the delay
3. Not operated during the delay

informal-bid contract: Contract that has *Informal Bid Authorized by Pub Cont Code § 10122* on the cover of the *Notice to Bidders and Special Provisions*.

job site: Area within the defined boundaries of a project.

Labor Surcharge and Equipment Rental Rates: Caltrans publication that lists labor surcharge and equipment rental rates.

landscaping: Practice of a landscaping contractor under 16 CA Code of Regs § 832.27.

material: Any product or substance specified for use in the construction of a project.

material shortage:

1. Shortage of raw or produced material that is area-wide and caused by an unusual market condition except if any of the following occurs:
 - 1.1. Shortage relates to a produced, nonstandard material
 - 1.2. Supplier's and the Contractor's priority for filling an order differs
 - 1.3. Event outside the United States for a material produced outside the United States
2. Unavailability of water that delays a controlling activity

material source facility audit: Self-audit and a Caltrans audit evaluating a facility's capability to consistently produce materials that comply with Caltrans standards.

median: Portion of a divided highway separating the traveled ways including inside shoulders.

milestone: Event activity that has zero duration and is typically used to represent the start or end of a certain stage of the project.

mobilization: Preparatory work that must be performed or costs incurred before starting work on the various items on the job site (Pub Cont Code § 10104).

modify: Add to or subtract from an appurtenant part.

narrative report: Document submitted with each schedule that discusses topics related to project progress and scheduling.

near critical path: Chain of activities with total float exceeding that of the critical path but having not more than 10 working days of total float.

obliterate: Place an earth cover over or root, plow, pulverize, or scarify.

Office engineer: The Director of Public Works and Planning for the County of Fresno

pavement: Uppermost layer of material placed on a traveled way or shoulder.

plans: Standard plans, revised standard plans, and project plans.

1. **standard plans:** Drawings standard to Department construction projects. These plans are in a book titled *Standard Plans*.
2. **revised standard plans:** New or revised standard plans. These plans are listed in the *List of Revised Standard Plans* in a book titled *Specifications*.
3. **project plans:** Drawings specific to the project, including authorized shop drawings. These plans also include a section titled *Project Details* of a book titled *Specifications*.

plant establishment period: Number of days shown on the *Notice to Bidders* for plant establishment.

quality characteristic: Characteristic of a material that is measured to determine conformance with a given requirement.

quality control plan: Contractor's plan to ensure QC.

reconstruct: Remove and disassemble and construct again at an existing or new location.

relocate: Remove and install or place in a new location.

remove: Remove and dispose of.

reset: Remove and install or place laterally at the same station location.

roadbed: Roadway portion extending from the curb line to curb line or the shoulder line to shoulder line.
A divided highway has 2 roadbeds.

roadside: Area between the outside shoulder edge and the right-of-way limits.

roadway: Portion of the highway within the outside lines of curbs, sidewalks, slopes, ditches, channels, or waterways. A roadway includes the structures and features necessary for safety, protection of facilities, and drainage.

salvage: Remove, clean, and haul to a specified location.

schedule:

1. **baseline schedule:** Initial schedule showing the original work plan starting on the date of Contract approval. This schedule shows no completed work to date and no negative float or negative lag to any activity.
2. **revised schedule:** Schedule that incorporates a proposed or past change to logic or activity durations.
3. **updated schedule:** Current schedule developed from the accepted baseline and any subsequent accepted updated or revised schedules through regular monthly review to incorporate actual past progress.

scheduled completion date: Planned work completion date shown on the current schedule.

shoulder: Roadway portion contiguous with the traveled way for accommodation of a stopped vehicle, emergency use, and lateral support of base and surface courses.

small tool: Tool or piece of equipment not listed in Labor Surcharge and Equipment Rental Rates that has a replacement value of \$500 or less.

specifications: Standard specifications, revised standard specifications, and special provisions.

1. **standard specifications:** Specifications standard to Department construction projects. These specifications are in a book titled *Standard Specifications*.
2. **revised standard specifications:** New or revised standard specifications. These specifications are in a section titled *Revised Standard Specifications* of a book titled *Specifications*.
3. **special provisions:** Specifications specific to the project. These specifications are in a section titled *Special Provisions* of a book titled *Specifications*.

State: State of California, including its agencies, departments or divisions whose conduct or action is related to the work.

Structure Design: Offices of Structure Design of the Department of Transportation.

subbase: Layer of material between a base and the basement material.

subgrade: Roadbed portion on which pavement, surfacing, base, subbase, or a layer of any other material is placed.

submittal:

1. **action submittal:** Written and graphic information and samples that require the Department's response.

2. **informational submittal:** Written information that does not require the Department's response.

substantial defects: Defects plainly seen as damaged, displaced, or missing parts or improper functioning of materials, parts, equipment, or systems.

substructure: Bridge parts below the bridge seats, pier tops, and haunches for rigid-framed bridges or spring lines for arched bridges; includes abutment backwalls, abutment parapets, and wingwalls.

superstructure: Bridge parts except the substructure.

supplemental project information: Information relevant to the project, specified as supplemental project information, and made available to bidders.

surfacing: Uppermost layer of material placed on a traveled way or shoulders; pavement.

time impact analysis: Analysis using a CPM schedule developed specifically to demonstrate the effect a proposed or past change or delay has on the current scheduled completion date.

time-scaled network diagram: Graphic depiction of a CPM schedule comprised of activity bars with relationships for each activity represented by arrows. The tail of each arrow connects to the activity bar for the predecessor and points to the successor.

total bid: Sum of the item totals as verified by the Department; original Contract price.

total float: Amount of time that an activity or chain of activities can be delayed before extending the scheduled completion date.

traffic: Pedestrians, bicyclists, ridden or herded animals, vehicles, streetcars, and other conveyances either singularly or together while using any highway for purposes of travel.

traffic lane: Portion of traveled way used for the movement of a single line of vehicles.

traveled way: Portion of the roadway for the movement of vehicles, exclusive of the shoulders, berms, sidewalks, and parking lanes.

tunnel: Tunnel as defined in 8 CA Code of Regs § 8405 et seq.

unauthorized work: Work performed beyond the lines and grades described in the Contract or established by the Engineer or extra work performed without Department authorization.

unsuitable material: Material encountered below the natural ground surface in embankment areas or below the grading plane in excavation areas that the Engineer determines to be in any of the following conditions:

1. Of such unstable nature that it cannot be compacted to the specified density using ordinary methods at optimum moisture content.
2. Too wet to be properly compacted and cannot be dried before incorporating it into the work. Excessive moisture alone is not sufficient cause for determining that the material is unsuitable.
3. Inappropriate for the planned use.

withhold: Money temporarily or permanently taken from a progress payment.

work: Resources and activities required for Contract acceptance, including labor, materials, equipment, and the created product.

work plan: Detailed formulation of a program of action.

work zone: Area of a highway with construction, maintenance, or utility work activities.

1-1.08 DISTRICTS

Replace Section 1.08 with:

Not Used

Add to the end of Section 1-1.09 with:

This project is not in a freeze-thaw area.

Replace Section 1-1.10 with:

1-1.10 PAVEMENT CLIMATE REGIONS

To help account for the effects of various climatic conditions on pavement performance, the State has been divided into 9 climate regions. Portions of the project are located in the Inland Valley climate region and portions are located in the Low Mountain climate region.

Replace Section 1-1.11 with:

1-1.11 WEBSITES, ADDRESSES, AND TELEPHONE NUMBERS

Websites, Addresses, and Telephone Numbers

Reference or agency or department unit	Website	Address	Telephone no.
Authorized Material Lists Authorized Material Source Lists	https://dot.ca.gov/programs/engineering-services/authorized-materials-lists	--	--
CA Unified Certification Program's list of certified DBEs	https://dot.ca.gov/programs/civil-rights/dbe-search	--	--
<i>California MUTCD</i>	https://dot.ca.gov/programs/safety-programs/camutcd	--	--
Department	http://www.co.fresno.ca.us	2220 Tulare Street Design Division – Seventh Floor Fresno, CA 93721	(559) 600-9908
Department of Conservation, Office of Mine Reclamation	http://www.conservation.ca.gov/dmr/	--	--
Department of Industrial Relations	http://www.dir.ca.gov	455 Golden Gate Ave San Francisco CA 94102	--
Design Services - Contract Administration, Planholders, Bid Results	https://www.co.fresno.ca.us/departments/public-works-planning/contractor-bids-plan-holders-electronic-plans-bid-results	2220 Tulare Street Design Division – Seventh Floor Fresno, CA 93721	Tel: (559) 600-9908 Fax:(559) 455-4609 Email: DesignServices@fresnocountyca.gov
Division of Accounting, Office of External Accounts Payable	https://dot.ca.gov/programs/accounting	Major Construction Payment and Information Unit Office of External Accounts Payable Division of Accounting Department of Transportation P.O. Box 168043 Sacramento, CA 95816-8043	(916) 227-9013
Division of Construction	http://www.dot.ca.gov/hq/construc/	--	--
Geotechnical Services	http://www.dot.ca.gov/hq/esc/geotech	Geotechnical Services Department of Transportation 5900 Folsom Blvd Sacramento, CA 95819-4612	(916) 227-7000
METS	http://www.dot.ca.gov/hq/esc/Translab/	Materials Engineering and Testing Services Department of Transportation 5900 Folsom Blvd Sacramento, CA 95819-4612	(916) 227-7000
<i>MPQP</i>	https://dot.ca.gov/programs/construction/material-plant-quality-program	--	--

Office Engineer	--	Director of Public Works & Planning Fresno County 2220 Tulare St, 8 th Floor Fresno, CA 93721	(559) 600-4078
Offices of Structure Design, Documents Unit	--	MSC 9-4/4I Documents Unit Offices of Structure Design Department of Transportation 1801 30th St Sacramento, CA 95816-7006	(916) 227-0716
Publication Distribution Unit	--	Publication Unit Department of Transportation 1900 Royal Oaks Dr Sacramento, CA 95815-3800	--

Replace Section 1-1.12 with:

1-1.12 MISCELLANY

Make checks and bonds payable to the County of Fresno.

Replace Section 2 with:

2 BIDDING

2-1.01 GENERAL

Section 2 includes specifications related to bid eligibility and the bidding process.

2-1.02 BID INELIGIBILITY

A firm that has provided architectural or engineering services to the Department for this contract before bid submittal for this contract is prohibited from any of the following:

1. Submitting a bid
2. Subcontracting for a part of the work
3. Supplying materials

2-1.03 CONTRACTOR REGISTRATION

No contractor or subcontractor may be listed on a bid proposal for a public works project unless registered with the Department of Industrial Relations pursuant to Labor Code section 1725.5 [with limited exceptions from this requirement for bid purposes only under Labor Code section 1771.1(a)].

2-1.04–2-1.05 RESERVED

2-1.06 BID DOCUMENTS

2-1.06A General

The *Bid* book includes bid forms and certifications and may be requested from Design Services and are available online at <http://www.BidExpress.com>.

The *Specifications* includes the *Notice to Bidders*, revised standard specifications, project details, and special provisions.

The *Specifications*, project plans, and any addenda to these documents may be accessed at Design Services.

The *Standard Specifications* and *Standard Plans* may be purchased at the Publication Distribution Unit or accessed online at <https://dot.ca.gov/programs/design/ccs-standard-plans-and-standard-specifications>.

2-1.06B Supplemental Project Information

The Department makes the following supplemental project information available:

Supplemental Project Information

Means	Description
Included in Project Details	Standard Encroachment Permit Application – Caltrans
Included in Project Details	Encroachment Permit Application – Tulare County

2-1.06C–2-1.06D Reserved

2-1.07 JOB SITE AND DOCUMENT EXAMINATION

Examine the job site and bid documents. Notify the Department of apparent errors and patent ambiguities in the plans, specifications, and Bid Item List. Failure to do so may result in rejection of a bid or rescission of an award.

Bid submission is your acknowledgment that you have examined the job site and bid documents and are satisfied with:

1. General and local conditions to be encountered
2. Character, quality, and scope of work to be performed
3. Quantities of materials to be furnished
4. Character, quality, and quantity of surface and subsurface materials or obstacles
5. Requirements of the contract

2-1.08 RESERVED

2-1.09 BID ITEM LIST

Submit a bid based on the bid item quantities the Department shows on Proposal 2.

2-1.10 SUBCONTRACTOR LIST

On the Subcontractor List form, list each subcontractor to perform work in an amount in excess of 1/2 of 1 percent of the total bid or \$10,000, whichever is greater (Pub Cont Code § 4100 et seq.).

For each subcontractor listed, the Subcontractor List form must show:

1. Business name and the location of its place of business.
2. California contractor license number for a non-federal-aid contract.
3. Public works contractor registration number.
4. Portion of work it will perform. Show the portion of the work by:
 - 4.1. Bid item numbers for the subcontracted work
 - 4.2. Percentage of the subcontracted work for each bid item listed
 - 4.3. Description of the subcontracted work if the percentage of the bid item listed is less than 100 percent

2-1.13–2-1.30 RESERVED

2-1.31 OPT OUT OF PAYMENT ADJUSTMENTS FOR PRICE INDEX FLUCTUATIONS

You may opt out of the payment adjustments for price index fluctuations specified in section 9-1.07. To opt out, submit a completed Opt Out of Payment Adjustments for Price Index Fluctuations form under section 2-1.33.

2-1.32 RESERVED

2-1.33 BID DOCUMENT COMPLETION AND SUBMITTAL

2-1.33A General

Complete forms in the *Bid* book.

Submit an electronic bid online at <http://www.BidExpress.com> (Section 2-1.33D) or submit a hardcopy bid:

1. Under sealed cover
2. Marked as a bid
3. Identifying the contract number and the bid opening date

Certain bid forms must be submitted with the bid and properly executed.

Certain other forms and information must be submitted either with the bid or within the prescribed period after bid opening as specified elsewhere in these special provisions.

Failure to submit the forms and information as specified results in a nonresponsive bid.

If an agent other than the authorized corporation officer or a partnership member signs the bid, file a Power of Attorney with the Department either before opening bids or with the bid. Otherwise, the bid may be nonresponsive.

2-1.33B Bid Item List and Bid Comparison

Submit a bid based on the bid item quantities the Department shows on Proposal 2. Bids will be evaluated and the low bidder determined as indicated in the *Notice to Bidders*.

Do not submit an unbalanced bid. An unbalanced bid is one in which one or more bid items is/are considered by the Department to have been bid at an amount that is unreasonably high or unreasonably low. A bid may be considered to be non-responsive and may be rejected if it is considered by the Department to be unbalanced.

2-1.33C Bid Document Completion

Proposal items are identified by title and by the word "Proposal" followed by the number assigned to the item sheet in question. Proposal items are included in the *Bid Book*.

2-1.33C(1) Proposal 1 - Proposal to the Board of Supervisors of Fresno County

2-1.33C(2) Proposal 2 - Bid Item List

One or more sheet(s) or list(s) upon which the bidder completes the bid.

Fill out completely including a unit price and total for each unit price-based item and a total for each lump sum item.

Do not make any additions such as "plus tax", "plus freight", or conditions such as "less 2% if paid by 15th".

Use ink or typewriter for paper bids.

2-1.33C(3) Proposal 3 - Evaluation of Bid Item List

Describes how inconsistencies and irregularities are evaluated and corrected when Design Services reviews the Bid Item List.

2-1.33C(4) Proposal 4 - Bid Security and Signature

Submit one of the following forms of bidder's security equal to at least 10 percent of the bid:

- Cash
- Cashier's check
- Certified check
- Signed bidder's bond by an admitted surety insurer

Indicate type of bid security provided.

- Cash – Acceptable but not recommended. Cash is deposited in a clearing account and is returned to bidders by County warrant. This process may take several weeks.
- Cashier's or Certified Checks. This type of security is held until the bid is no longer under consideration. If submitted by a potential awardee, they will be returned when the contract is fully executed by the bidder and bonds and insurance have been approved.
- Bid Bonds - Must be signed by the bidder and by the attorney-in-fact for the bonding company. Provide notarized signature of attorney-in-fact accompanied by bonding company's affidavit authorizing attorney-in-fact to execute bonds. An unsigned bid bond will be cause for rejection.

Provide contractor's license information.

State business name and if business is a:

- Corporation - list officers
- Partnership - list partners
- Joint Venture - list members; if members are corporations or partnerships, list their officers or partners.
- Individual - list Owner's name and firm name style

Signature of Bidder - the following lists types of companies and corresponding authorized signers.

- Corporation - by an officer
- Partnership - by a partner
- Joint Venture - by a member
- Individual - by the Owner

If signature is by a Branch Manager, Estimator, Agent, etc., the bid must be accompanied by a power of attorney authorizing the individual to sign the bid in question or to sign bids more generally, otherwise the bid may be rejected.

Business Address - Firm's Street Address

Mailing Address - P.O. Box or Street Address

Complete, sign, and return with bid.

2-1.33C(5) Proposal 5 - Noncollusion Declaration

Must be completed, signed, and returned with bid.

2-1.33C(6) Proposal 6 - Public Contract Code Section 10285.1 Statement

Select "has" or "has not" in accordance with instructions on form, return with completed for with bid. Note that signing the bid constitutes signing this statement.

2-1.33C(7) Proposal 7 - Public Contract Code Section 10162 Questionnaire And Public Contract Code 10232 Statement

Select: "yes" or "no" accordance with instructions on form, include explanation if "yes" is selected. Return completed form with bid. Note that signing the bid constitutes signing this questionnaire and statement.

2-1.33C(8) Proposal 8(a) through Proposal 8(f) - Subcontractors

Sheet(s) or spaces where bidders list subcontractors. List each subcontractor to perform work in an amount in excess of 1/2 of 1 percent of the total bid or \$10,000, whichever is greater (Pub Cont Code § 4100 et seq.).

The *Subcontractor List* submitted with the bid must show the name, location of business, work portions to be performed, and the contractor's license number for each subcontractor listed.

- Use subcontractor's business name style as registered with the License Board.
- Specify the city in which the subcontractor's business is located and the state if other than California.
- Description of the work to be performed by the subcontractor. Indicate with bid item numbers from the bid item list and/or work descriptions similar to those on bid item list.
- List license number and Department of Industrial Relations registration number for each subcontractor.

Upon request from Design Services, provide the following additional information within 24 hours of bid opening if not included on the *Subcontractor List* submitted with the bid:

- Complete physical address for each subcontractor listed.
- Percentage of the total bid or dollar amount associated with each subcontractor listed.

2-1.33C(16) Proposal 16 - Opt out of payment adjustments for price index fluctuations

You may opt out of the payment adjustments for price index fluctuations specified in section 9-1.07. To opt out, submit a completed *Opt Out of Payment Adjustments for Price Index Fluctuations* form with your bid.

2-1.33C(17) Proposal 17 - Guaranty

Does not need to be signed with the bid. Part of the contract which must be signed by the contractor when contract is executed.

Section 2-1.33D Electronic Bid Document Completion

Electronic versions of the bid book documents are available online at <http://www.BidExpress.com>, and may be submitted through that website.

You must either attach an electronic bid bond or provide an original bid bond (or other form of bid security authorized by Public Contract Code Section 20129(a)), prior to the bid opening.

Bidders submitting online may use one of the accepted electronic sureties (SurePath or Surety 2000) to submit their bid bond; or may submit cash, cashier's check, certified check, or a bidder bond to Design Services at 2220 Tulare St., Seventh Floor, Fresno, CA 93721. Those submitting bid bonds directly to Design Services must submit their bid bond:

1. Under sealed cover
2. Marked as a bid-bond
3. Identifying the contract number and the bid opening date on the cover

Note: While it is strongly encouraged that you comply with the above bidding requirements if at all possible, it is acknowledged that this bid opening is occurring during the COVID-19 State of Emergency in Fresno County, the impact of which is immense. If, as a result of the emergency, you are unable to provide the original bid security or electronic bid bond prior to the bid opening (and if your bid is otherwise appropriately responsive to bid requirements), then staff will request that the Board of Supervisors consider exercising its discretion to waive the bidding irregularity (regarding the time of delivery of the bid security) IF you: (1) attach a scanned copy of the original bid security to the Bid; and (2) provide for hand-delivery of the original bid security to the County within 24 hours of the bid opening. **If necessary, please e-mail DesignServices@fresnocountyca.gov or call (559) 600-9908, so that arrangements may be made to hand deliver your bid bond.**

2-1.34 BIDDER'S SECURITY

Submit one of the following forms of bidder's security equal to at least 10 percent of the bid:

1. Cash
2. Cashier's check
3. Certified check
4. Signed bidder's bond by an admitted surety insurer

Submit cash, cashier's check, certified check, or bidder's bond with your bid.

2-1.35–2-1.39 RESERVED

2-1.40 BID WITHDRAWAL

1. An authorized agent may withdraw a bid before the bid opening date and time by submitting a written bid withdrawal request at the location where the bid was submitted. Withdrawing a bid does not prevent you from submitting a new bid. An authorized agent is an individual authorized to submit a bid.
2. After the bid opening time, you cannot withdraw a bid.

2-1.41–2-1.42 RESERVED

2-1.43 BID OPENING

The Department publicly opens and reads bids at the time and place shown on the *Notice to Bidders*.

2-1.44–2-1.45 RESERVED

2-1.46 DEPARTMENT'S DECISION ON BID

The Department's decision on the bid amount is final.

The Department may reject:

1. All bids
2. A nonresponsive bid

2-1.47 BID RELIEF

The Department may grant bid relief under Pub Cont Code § 5100 et seq. Submit any request for bid relief to Design Services.

2-1.48 RESERVED

2-1.49 SUBMITTAL FAILURE HISTORY

The Department considers a bidder's past failure to submit documents required after bid opening in determining a bidder's responsibility.

2-1.51 DISCLOSURE OF SELF-DEALING TRANSACTIONS

This provision is only applicable if the contractor is operating as a corporation (a for-profit or non-profit corporation) or if during the term of this agreement, the contractor changes its status to operate as a corporation.

Members of the contractor's Board of Directors shall disclose any self-dealing transactions that they are a party to while contractor is providing goods or performing services under this agreement. A self-dealing transaction shall mean a transaction to which the contractor is a party and in which one or more of its directors has a material financial interest. Members of the Board of Directors shall disclose any self-dealing transactions that they are a party to by completing and signing a Self-Dealing Transaction Disclosure Form which is included in *Project Details* of these special provisions.

In the event that the Contractor (to whom the project is awarded) is operating as a corporation or incorporates during the course of the construction contract, and any member of its board of directors is engaged or intends to become engaged in self-dealing transaction(s), each member of its board of directors who is engaged or intends to become engaged in a self-dealing transaction or transactions must complete and submit to the County a completed Self-Dealing Transaction Disclosure Form (in Project Details) for each such transaction prior to engaging therein or immediately thereafter.

3 CONTRACT AWARD AND EXECUTION

Replace the headings and paragraphs of Section 3 with:

3-1.01 GENERAL

Section 3 includes specifications related to contract award and execution.

3-1.02 CONSIDERATION OF BIDS

3-1.02A General

Bids will be compared on the basis listed in the Notice to Bidders.

3-1.02B Tied Bids

The Department breaks a tied bid with a coin toss:

3-1.03 CONTRACTOR REGISTRATION

No contractor or subcontractor may be awarded a contract for public work on a public works project (awarded on or after April 1, 2015) unless registered with the Department of Industrial Relations pursuant to Labor Code section 1725.5.

3-1.04 CONTRACT AWARD

3-1.04A BID PROTEST PROCEDURES

Any bid protest must be submitted in writing and delivered by the Bidder by either of the following means: (1) via e-mail to DesignServices@fresnocountyca.gov; or (2) via certified mail, return receipt requested to the following address: Design Division, Department of Public Works and Planning, 2220 Tulare Street, Sixth Floor, Fresno, CA 93721.

The bid protest must be received no later than 5:00 p.m. of the seventh (7th) calendar day following the deadline for submittal of the specific bid document(s) placed at issue by the protest. Any Bidder filing a protest is encouraged to submit the bid protest via e-mail, because the deadline is based on the Department's receipt of the bid protest. A bid protest accordingly may be rejected as untimely if it is not received by the deadline, regardless of the date on which it was postmarked. The Bidder's compliance with the following additional procedures also is mandatory:

- a. The initial protest document shall contain a complete statement of the grounds for the protest, including a detailed statement of the factual basis and any supporting legal authority.
- b. The protest shall identify and address the specific portion of the document(s) forming the basis for the protest.

c. The protest shall include the name, address and telephone number of the person representing the protesting party.

d. The Department will provide a copy of the initial protest document and any attached documentation to all other Bidders or proposers who appear to have a reasonable prospect of receiving an award depending upon the outcome of the protest.

e. The Board of Supervisors will issue a decision on the protest. If the Board of Supervisors determines that a protest is frivolous, the party originating the protest may be determined to be irresponsible and that party may be determined to be ineligible for future contract awards.

f. The procedure and time limits set forth herein are mandatory and are the Bidder's sole and exclusive remedy in the event of a bid protest. Failure by the Bidder to comply with these procedures shall constitute a waiver of any right to further pursue the bid protest, including the subsequent filing of a Government Code Claim or legal proceedings.

3-1.04B AWARD PERIOD

If the Department awards the contract, the award is made to the lowest responsible bidder within 54 calendar days after bid opening.

The Department may extend the specified award period if the Bidder agrees.

You may request to extend the award period by faxing a request to Design Services before 4:00 p.m. on or before the last day of the award period. If you do not make this request, after the specified award period:

1. Your bid becomes invalid
2. You are not eligible for the award of the contract

3-1.05 CONTRACT BONDS (PUB CONT CODE §§ 10221 AND 10222)

The successful bidder must furnish 2 bonds conforming to the requirements in the *Agreement* of these special provisions.

3-1.06 CONTRACTOR LICENSE

For a federal-aid contract, the Contractor must be properly licensed as a contractor from contract award through Contract acceptance (Pub Cont Code § 10164).

For a non-federal-aid contract:

1. Contractor must be properly licensed as a contractor from bid opening through Contract acceptance (Bus & Prof Code § 7028.15)
2. Joint venture bidders must obtain a joint venture license before contract award (Bus & Prof Code § 7029.1)

3-1.07 INSURANCE POLICIES

The successful bidder must submit copies of its insurance policies conforming to the requirements in the *Agreement* of these special provisions.

3-1.08 –3-1.10 RESERVED

3-1.11 PAYEE DATA RECORD

Complete and deliver to the Engineer a Payee Data Record form when requested by the Engineer.

3-1.12 RESERVED

3-1.14–3-1.17 RESERVED

3-1.18 CONTRACT EXECUTION

The successful bidder must sign the *Agreement*.

Deliver to Design Services:

1. Signed *Agreement* including the attached form FHWA-1273
2. Contract bonds
3. Documents identified in section 3-1.07
4. For a federal-aid contract, *Local Agency Bidder - DBE Information* form

Design Services must receive these documents before the 10th business day after the bidder receives the contract.

The bidder's security may be forfeited for failure to execute the contract within the time specified (Pub Cont Code §§ 10181, 10182, and 10183).

3-1.19 BIDDERS' SECURITIES

The Department keeps the securities of the 1st, 2nd, and 3rd low bidders until the contract has been executed. The other bidders' securities, other than bidders' bonds, are returned upon determination of the 1st, 2nd, and 3rd low bidders, and their bidders' bonds are of no further effect (Pub Cont Code § 10184).

4 SCOPE OF WORK

Replace Section 4-1.02 with:

4-1.02 INTENT

The Contract intent is to provide for work completion using the best general practices.

Be prepared to perform and complete work, in a safety manner, on an existing road under narrow, winding, and steep (up to 22 percent) conditions.

Nothing in the specifications, special provisions, Standard Specifications, or in any other Contract document voids the Contractor's public safety responsibilities.

Replace Section 4-1.07C with:

4-1.07C Reserved

Replace Section 4-1.13 with:

4-1.13 CLEANUP

Before final inspection, leave the job site neat and presentable and dispose of:

1. Rubbish
2. Excess materials
3. Falsework
4. Temporary structures
5. Equipment

Remove warning, regulatory, and guide signs when directed by the Engineer.

5 CONTROL OF WORK

Delete the 9th Paragraph of Section 5-1.01

Add the following before the last sentence in Section 5-1.02

Caltrans Standard Plans, City of Fresno Standard Drawings, and any other other-agency Standard Drawings included in the "Project Details" section of the book entitled "Specifications" have the same ranking as Standard Plans."

All other drawings in the "Project Details" section of the book entitled "Specifications" have the same ranking as Project Plans.

Tables and other documents in the "Project Details" section of the book entitled "Specifications" have the same ranking as Special Provisions. If a portion of a document in the Project Details section conflicts with the Special Provisions, the Special Provisions shall prevail.

Replace Section 5-1.09 with:

5-1.09 RESERVED

Replace Section 5-1.12 with:

5-1.12 ASSIGNMENT

No third-party agreement relieves you or your surety of the responsibility to complete the work. Do not sell, transfer, or otherwise dispose of any Contract part without prior written consent from the Department.

If you assign the right to receive Contract payments, the Engineer accepts the assignment upon the Engineer's receipt of a notice. Assigned payments remain subject to deductions and withholds described in the Contract. The Department may use withheld payments for work completion whether payments are assigned or not.

A pending or disapproved request for assignment does not relieve you of the responsibility to commence and pursue work timely and in strict accordance with contract documents.

Replace Section 5-1.13C with:

5-1.13C RESERVED

Replace Section 5-1.13D with:

5-1.13D RESERVED

Add the following paragraph to the end of section 5-1.16 with:

Submit Daily Log records to the Engineer weekly for the entire course of work unless the Engineer requests another interval.

Replace Section 5-1.20B(4) with:

5-1.20B(4) Contractor–Property Owner Agreement

Before procuring material from or disposing or stockpiling of material on non-highway property:

1. Provide proof that the property where materials are to be stockpiled or equipment parked/stored is appropriately zoned and/or permitted for the use proposed by the Contractor.
2. Obtain written authorization from each and every owner of the property where materials are to be stockpiled or equipment parked/stored.
3. Provide proof that the signor(s) of the authorization are the owners of the property.
4. Provide an executed release from the property owner(s) absolving the Department from any and all responsibility in connection with the stockpiling of materials or parking/storage of equipment on said property.
5. Obtain written permission from the Engineer to stockpile materials or park/store equipment at the location designated in said authorization.

Before Contract acceptance, submit a document signed by the owner of the material source or disposal site stating that the Contractor has complied with the Contractor-owner agreement.

Failure by the Contractor to provide written authorization shall result in the withholding of all funds due to the Contractor until said authorization is received by the County.

Replace Section 5-1.20C with:

5-1.20C Railroad Relations

If the Contract includes an agreement with a railroad company, the Department makes the provisions of the agreement available in Project Details in the document titled "Railroad Relations and Insurance Requirements." Comply with the requirements in the document.

Replace Section 5-1.23A with:

5-1.23A General

Section 5-1.23 includes specifications for action and informational submittals.

Any submittal not specified as an informational submittal is an action submittal.

Submit action and informational submittals to the Engineer. Unless otherwise specified in these Specifications, submittals shall be provided via email in .pdf format.

Each submittal must have a cover sheet that must include:

1. Contract number
2. Project Name
3. Date
4. Submittals (and resubmittals if applicable) must be numbered sequentially
5. Structure number if applicable
6. Contractor
7. Person responsible for submitting the submittal
8. Signature of Contractor's representative sending submittal
9. Section number and/or item submittal is referencing
10. Pages of submittal, excluding cover sheet

The Department rejects a submittal if it has any error or omission.

If the last day for submitting a document falls on a Saturday or holiday, it may be submitted on the next business day with the same effect as if it had been submitted on the day specified.

Documents must be submitted in the English language.

Convert documents to US customary units.

Replace Section 5-1.27E with:

5-1.27E CHANGE ORDER BILLS

Maintain separate records for change order work costs.

5-1.32 AREAS FOR USE

Occupy the highway only for purposes necessary to perform the work.

Defend, indemnify, and hold the Department harmless to the same extent as under section 7-1.05.

The Department does not allow temporary residences within the County right-of-way.

6 CONTROL OF MATERIALS

Replace section 6-1.05 with:

6-1.05 SPECIFIC BRAND OR TRADE NAME AND SUBSTITUTION

Unless substitution is expressly precluded in the special provisions, a reference to a specific brand or trade name establishes a quality standard and is not intended to limit competition. Unless the Department has made a public interest finding expressly authorizing sole source procurement of a particular item, you may use a product that is equal to or better than the specified brand or trade name if authorized.

Submit a substitution request with a time period that:

1. Follows Contract award
2. Allows 30 days for review
3. Causes no delay

Include substantiating data with the substitution request that proves that substitution:

1. Causes no delay
2. Is of equal or better quality and suitability

If the special provisions disallow substitution of a particular item, provide the specified item and do not propose substitution.

7 LEGAL RELATIONS AND RESPONSIBILITY TO THE PUBLIC

Replace the 2nd Paragraph of Section 7-1.02K(2) with:

The general prevailing wage rates and any applicable changes to these wage rates are available:

1. From Design Services
2. From the Department of Industrial Relations' Web site

Replace section 7-1.02K(3) with:

Keep accurate payroll records.

Submit a copy of your certified payroll records, weekly, including those of subcontractors. Include:

1. Each employee's:
 - 1.1. Full name
 - 1.2. Address
 - 1.3. Social security number
 - 1.4. Work classification
 - 1.5. Straight time and overtime hours worked each day and week
 - 1.6. Actual wages paid for each day to each:
 - 1.6.1. Journeyman
 - 1.6.2. Apprentice
 - 1.6.3. Worker
 - 1.6.4. Other employee you employ for the work
 - 1.7. Pay rate
 - 1.8. Itemized deductions made
 - 1.9. Check number issued
 - 1.10. Fringe Benefits
2. Apprentices and the apprentice-to-journeyman ratio

Each certified payroll record must include a Statement of Compliance form signed under penalty of perjury that declares:

1. Information contained in the payroll record is true, correct, and complete

2. Employer has complied with the requirements of sections 1771, 1811, and 1815 for any work performed by his or her employees on the public works project
3. Wage rates paid are at least those required by the Contract

Submitted certified payrolls for hauling and delivering ready-mixed concrete must be accompanied by a written time record. The time record must include:

1. Truck driver's full name and address
2. Name and address of the factory or batching plant
3. Time the concrete was loaded at the factory or batching plant
4. Time the truck returned to the factory or batching plant
5. Truck driver's signature certifying under penalty of perjury that the information contained in this written time record is true and correct

Make certified payroll records available for inspection at all reasonable hours at your main office on the following basis:

1. Upon the employee's request or upon request of the employee's authorized representative, make available for inspection a certified copy of the employee's payroll record.
2. Refer the public's requests for certified payroll records to the Department. Upon the public's request, the Department makes available for inspection or furnishes copies of your certified payroll records. Do not give the public access to the records at your main office.

Make all payroll records available for inspection and copying or furnish a copy upon request of a representative of the:

1. Department
2. Division of Labor Standards Enforcement of the Department of Industrial Relations
3. Division of Apprenticeship Standards of the Department of Industrial Relations

Furnish the Department the location of the records. Include the street address, city, and county. Furnish the Department a notification of a location and address change within 5 business days of the change.

Comply with a request for the records within 10 days after you receive a written request. If you do not comply within this period, the Department withholds from progress payments a \$100 penalty for each day or part of a day for each worker until you comply. You are not assessed this penalty for a subcontractor's failure to comply with Labor Code § 1776.

The Department withholds from progress payments for delinquent or inadequate records (Labor Code § 1771.5). If you have not submitted an adequate record by the month's 15th day for the period ending on or before the 1st of that month, the Department withholds up to 10 percent of the monthly progress estimate, exclusive of mobilization. The Department does not withhold more than \$10,000 or less than \$1,000.

7-1.02K(4)i Apprenticeship Requirements for non-Federal Projects

- A. Pursuant to Sections 1770-1780 of the Labor Code of the State of California, the Director of the Department of Industrial Relations has determined the general prevailing rate of wages in the locality for each craft or type of worker needed to execute the work. Said wage rates pursuant to Section 1773.2 of the Labor Code are on file with the Clerk to the Fresno County Board of Supervisors, and will be made available to any interested person on request. A copy of this wage scale may also be obtained at the following Web Site: www.dir.ca.gov/dlsr.
- B. Pursuant to Section 1775 of the Labor Code of the State of California, nothing in this Article shall prevent the employment of properly registered apprentices upon public works. Every such apprentice shall be paid the standard wage paid to apprentices under the regulations of

the craft or trade at which he/she is employed, and shall be employed only at the work of the craft or trade to which he/she is registered.

- C. Only apprentices, as defined in Section 3077, who are in training under apprenticeship standards and written apprentice agreements under Chapter 4 (commencing at Section 3070), Division 3, of the Labor Code, are eligible to be employed on public works. The employment and training of each apprentice shall be in accordance with the provisions of the apprenticeship standards and apprentice agreements under which he/she is training.
- D. Fresno County is committed to increasing the availability of employment and training opportunities, with particular attention to the plight of those who are most economically disadvantaged. In an effort to advance that purpose, the County will require that the Contractor and each subcontractor employed on this Project shall use their best efforts to ensure that thirty-three percent (33%) of apprentice hours, as determined by California Labor Code Section 1777.5 for each contractor and subcontractor of any tier on this Project, are performed by qualified participants in state approved apprenticeship programs who also are current or former "Welfare-to-Work" participants in the CalWORKs program. Provided, that nothing contained in this Paragraph D shall be interpreted to relieve or in any way diminish the obligation of the Contractor and each subcontractor to comply fully with all applicable apprenticeship laws in accordance with the California Labor Code and the California Code of Regulations; and accordingly such requirements as are contractually imposed by this Paragraph D shall be in addition to such legally mandated requirements, and applicable only to the extent fully consistent therewith.

Replace Section 7-1.04 with:

7-1.04 PUBLIC SAFETY

7-1.04A GENERAL

You are responsible to provide for public safety.

Do not construct a temporary facility that interferes with the safe passage of traffic.

Control dust resulting from the work, inside and outside the right-of-way.

Move workers, equipment, and materials without endangering traffic.

Whenever your activities create a condition hazardous to the public, furnish, erect and maintain those fences, temporary railing, barricades, lights, signs, and other devices and take any other necessary protective measures to prevent damage or injury to the public.

Any fences, temporary railing, barricades, lights, signs, or other devices furnished, erected and maintained by you are in addition to those for which payment is provided elsewhere in the specifications.

Provide flaggers whenever necessary to ensure that the public is given safe guidance through the work zone. At locations where traffic is being routed through construction under one-way controls, move your equipment in compliance with the one-way controls unless otherwise ordered.

Use of signs, lights, flags, or other protective devices must comply with the *California MUTCD* and any directions of the Engineer. Signs, lights, flags or other protective devices must not obscure the visibility of, nor conflict in intent, meaning, and function of either existing signs, lights and traffic control devices, or any construction area signs.

Keep existing traffic signals and highway lighting in operation. Other forces within the Department will perform routine maintenance of these facilities during the work.

Cover signs that direct traffic to a closed area.

Install temporary illumination in a manner which the illumination and the illumination equipment does not interfere with public safety. The installation of general roadway illumination does not relieve you from furnishing and maintaining any protective devices.

Equipment must enter and leave the highway via existing ramps and crossovers and must move in the direction of traffic. All movements of workmen and construction equipment on or across lanes open to traffic must be performed in a manner that do not endanger the public. Your vehicles or other mobile equipment leaving an open traffic lane to enter the construction area must slow down gradually in advance of the location of the turnoff to give the traffic following an opportunity to slow down. When leaving a work area and entering a roadway carrying traffic, your vehicles and equipment must yield to traffic.

Immediately remove hauling spillage from a roadway lane or shoulder open to traffic. When hauling on roadways, trim loads and remove material from shelf areas to minimize spillage.

Notify the Engineer not less than 5 days before the anticipated start of an activity that will change the vertical or horizontal clearance available to traffic, including shoulders.

If vertical clearance is temporarily reduced to 15.5 feet or less, place low clearance warning signs in compliance with the *California MUTCD* and any directions of the Engineer. Signs must comply with the dimensions, color, and legend requirements of the *California MUTCD* and section 12-3.06 except that the signs must have black letters and numbers on an orange retroreflective background. W12-2P signs must be illuminated so that the signs are clearly visible.

Pave or provide full width continuous and cleared wood walks for pedestrian openings through falsework. Protect pedestrians from falling objects and concrete-curing water. Extend overhead protection for pedestrians at least 4 feet beyond the edge of the bridge deck. Illuminate all pedestrian openings through falsework. Temporary pedestrian facilities must comply with the *California MUTCD*, Part 6, Chapter 6D, "Pedestrian and Worker Safety."

Do not store vehicles, material, or equipment in a way that:

1. Creates a hazard to the public
2. Obstructs traffic control devices

Do not install or place temporary facilities used to perform the work which interfere with the free and safe passage of traffic.

Temporary facilities that could be a hazard to public safety if improperly designed must comply with design requirements described in the Contract for those facilities or, if none are described, with standard design criteria or codes appropriate for the facility involved. Submit shop drawings and design calculations for the temporary facilities and show the standard design criteria or codes used. Shop drawings and supplemental calculations must be sealed and signed by an engineer who is registered as a civil engineer in the State.

If you appear to be neglectful or negligent in furnishing warning devices and taking protective measures, the Engineer may direct your attention to the existence of a hazard. You must furnish and install the necessary warning devices. If the Engineer points out the inadequacy of warning devices and protective measures, that action on the part of the Engineer does not relieve you from your responsibility for public safety or abrogate your obligation to furnish and pay for these devices and measures.

Install Type K temporary railing or other authorized protective systems under any of the following conditions:

1. Excavations: Where the near edge of the excavation is within 15 feet from the edge of an open traffic lane
2. Temporarily unprotected permanent obstacles: When the work includes the installation of a fixed obstacle together with a protective system, such as a sign structure together with protective railing,

and you elect to install the obstacle before installing the protective system; or you, for your convenience and as authorized, remove a portion of an existing protective railing at an obstacle and do not replace such railing completely the same day

3. Storage areas: When material or equipment is stored within 15 feet of the edge of an open traffic lane and the storage is not otherwise prohibited by the Contract
4. Height differentials: When construction operations create a height differential greater than 0.15 feet within 15 feet of the edge of traffic lane

Installation of Type K temporary railing is not required if an excavation within 15 feet from the edge of an open traffic lane is protected by any of the following:

1. Steel plate or concrete covers of adequate thickness to prevent accidental entry by traffic or the public
2. Side slope where the downhill slope is 4:1 (horizontal: vertical) or less unless a naturally occurring condition
3. Barrier or railing

Offset the approach end of Type K temporary railing a minimum of 15 feet from the edge of an open traffic lane. Install the temporary railing on a skew toward the edge of the traffic lane of not more than 1 foot transversely to 10 feet longitudinally with respect to the edge of the traffic lane. If the 15-foot minimum offset cannot be achieved, the temporary railing must be installed on the 10 to 1 skew to obtain the maximum available offset between the approach end of the railing and the edge of the traffic lane, and an array of temporary crash cushion modules must be installed at the approach end of the temporary railing.

Secure Type K temporary railing in place before starting work for which the temporary railing is required.

Where 2 or more lanes in the same direction are adjacent to the area where the work is being performed, including shoulders, the adjacent lane must be closed under any of the following conditions:

1. Work is off the traveled way but within 6 feet of the edge of the traveled way, and the approach speed is greater than 45 miles per hour
2. Work is off the traveled way but within 3 feet of the edge of the traveled way, and the approach speed is less than 45 miles per hour

Closure of the adjacent traffic lane is not required when performing any of the following:

1. Working behind a barrier
2. Paving, grinding, or grooving
3. Installing, maintaining, or removing traffic control devices except Type K temporary railing

Do not reduce an open traffic lane width to less than 10 feet. When traffic cones or delineators are used for temporary edge delineation, the side of the base of the cones or delineators nearest to traffic is considered the edge of the traveled way.

If a traffic lane is closed with channelizers for excavation work, move the devices to the adjacent edge of the traveled way when not excavating. Space the devices as specified for the lane closure.

Do not move or temporarily suspend anything over a traffic lane open to the public unless the public is protected.

7-1.04B WORK ZONE SAFETY AND MOBILITY

7-1.04B(1) POLICY

In order to ensure safe and efficient flow of traffic through work zones, the County of Fresno, via its General Plan, Transportation and Circulation Element, Policy TRA-1, has adopted the use of AASHTO Standards as supplemented by Caltrans and County Department of Public Works and Planning Standards.

7-1.04B(2)TRAFFIC MANAGEMENT PLAN

Perform traffic management shall be in accordance with Section 12, "TEMPORARY TRAFFIC CONTROL," of these special provisions.

7-1.04B(3)TEMPORARY TRAFFIC CONTROL PLAN

Prepare traffic control plan(s) in accordance with Section 12, "TEMPORARY TRAFFIC CONTROL," of these special provisions.

7-1.04B(4)PUBLIC INFORMATION

Provide notice to public agencies and others to the extent required, if any, elsewhere in these special provisions. The Engineer provides other noticing not identified to be performed by the Contractor.

Replace Section 7-1.06 with:

7-1.06 INSURANCE

7-1.06A General

Nothing in the Contract is intended to establish a standard of care owed to any member of the public or to extend to the public the status of a third-party beneficiary for any of these insurance specifications.

7-1.06B Casualty Insurance

Obtain and maintain insurance on all of your operations with companies acceptable to the Department as follows:

1. Keep all insurance in full force and effect from the start of the work through Contract acceptance.
2. All insurance must be with an insurance company with a rating from A.M. Best Financial Strength Rating of A or better and a Financial Size Category of VIII or better.
3. Maintain completed operations coverage with a carrier acceptable to the State through the expiration of the patent deficiency in construction statute of repose set forth in Civ Pro Code § 337.1.

7-1.06C Workers' Compensation and Employer's Liability Insurance

Under Labor Code § 1860, secure the payment of worker's compensation under Labor Code § 3700.

Submit to the Department the following certification before performing the work (Labor Code § 1861):

I am aware of the provisions of Section 3700 of the Labor Code which require every employer to be insured against liability for workers' compensation or to undertake self-insurance in accordance with the provisions of that code, and I will comply with such provisions before commencing the performance of the work of this contract.

Contract signing constitutes certification submittal.

Provide Employer's Liability Insurance in amounts not less than:

1. \$1,000,000 for each accident for bodily injury by accident
2. \$1,000,000 policy limit for bodily injury by disease
3. \$1,000,000 for each employee for bodily injury by disease

If there is an exposure of injury to your employees under the U.S. Longshoremen's and Harbor Workers' Compensation Act, the Jones Act, or under laws, regulations, or statutes applicable to maritime employees, coverage must be included for such injuries or claims.

7-1.06D Liability Insurance

7-1.06D(1) General

Carry General Liability and Umbrella or Excess Liability Insurance covering all operations by or on behalf of you providing insurance for bodily injury liability and property damage liability for the following limits and including coverage for:

1. Premises, operations and mobile equipment
2. Products and completed operations
3. Broad form property damage (including completed operations)
4. Explosion, collapse, and underground hazards
5. Personal injury
6. Contractual liability

7-1.06D(2) Liability Limits/Additional Insureds

Refer to the *Agreement* of these special provisions

Additional insured coverage must be provided by a policy provision or by an endorsement providing coverage at least as broad as *Additional Insured* (Form B) endorsement form CG 2010, as published by the Insurance Services Office (ISO), or other form designated by the Department.

7-1.06D(3) Contractor's Insurance Policy is Primary

The policy must stipulate that the insurance afforded the additional insureds applies as primary insurance. Any other insurance or self-insurance maintained by the State is excess only and must not be called upon to contribute with this insurance.

7-1.06E Automobile Liability Insurance

Comply with requirements in the *Agreement* of these special provisions

7-1.06F Policy Forms, Endorsements, and Certificates

Provide your General Liability Insurance under Commercial General Liability policy form no. CG0001 as published by the Insurance Services Office (ISO) or under a policy form at least as broad as policy form no. CG0001.

7-1.06G NOT USED

7-1.06H Enforcement

The Department may assure your compliance with your insurance obligations. Ten days before an insurance policy lapses or is canceled during the Contract period you must submit to the Department evidence of renewal or replacement of the policy.

If you fail to maintain any required insurance coverage, the Department may maintain this coverage and withhold or charge the expense to you or terminate your control of the work.

You are not relieved of your duties and responsibilities to indemnify, defend, and hold harmless the State, its officers, agents, and employees by the Department's acceptance of insurance policies and certificates.

Minimum insurance coverage amounts do not relieve you for liability in excess of such coverage, nor do they preclude the State from taking other actions available to it, including the withholding of funds under this Contract.

7-1.06I Self-Insurance

Comply with the *Agreement* of these special provisions

Replace Section 7-1.07 with:

7-1.07 LEGAL ACTIONS AGAINST THE DEPARTMENT

7-1.07A General

If legal action is brought against the Department over compliance with a State or federal law, rule, or regulation applicable to highway work, then:

1. If the Department in complying with a court order prohibits you from performing work, the resulting delay is a suspension related to your performance, unless the Department terminates the Contract.
2. If a court order other than an order to show cause or the final judgment in the action prohibits the Department from requiring you to perform work, the Department may delete the prohibited work or terminate the Contract.

7-1.07B Seal Coat Claims

This section applies to seal coat projects. Pay for claims for personal property damage caused by screening and bituminous binder. Seal coat claims are limited to:

1. 10 percent of the total bid
2. Damage occurring between the 1st day of screening spreading and 4 days after the last day of screening spreading for each seal coat location

Within 30 days of the last screening spreading, do the following:

1. Process and resolve all claims reported or submitted to you by the public as follows:
 - 1.1. Within 3 business days of receipt of a claim, submit to the Department a copy of the claim, a written analysis of the claim, and a statement indicating whether or not you will pay the claim. If you reject a claim, provide the reasons for rejection in writing.
 - 1.2. If the claimant becomes dissatisfied with your handling of the claim, immediately refer the claimant to the local district claims office for assistance in resolving the claim.
2. Submit to the Department evidence of your paid claims.

All claims presented to the Department, any district claims office, or the State Board of Control (Govt Code § 900 et seq.) are processed and resolved by the Department as follows:

1. The claims are processed as formal government claims subject to all laws and policies and are resolved as the Department determines including referring the claim to you for handling.
2. If the Department or the State Board of Control approves settlement of a claim or is ordered to pay pursuant to a court order, the claim is paid from funds withheld from you.
3. Within 3 business days of the Department's determination that you are responsible for resolving the claim, the Department sends a copy of the claim to you for resolution or notifies you of the Department's decision to resolve the claim.

The Department withholds an amount not to exceed 5 percent of the total bid to resolve all claims. The amount is held no longer than 60 days following the last spreading of screenings so that the Department has ample time to resolve any pending claims. After 60 days, any remaining amount withheld is returned to you.

If no withheld funds remain or have been returned, the Department may pay any claims and seek reimbursement from you through an offset or any other legal means. Any reimbursement or offset to be recovered from you, including all other paid claims, is limited to 10 percent of the total bid.

Section 7-1.07B does not limit your obligation to defend and indemnify the Department.

7-1.07C Claims

This section applies to non-seal coat projects which involve asphalt concrete paving. Pay for claims for personal property damage caused by your work. Claims are limited to:

1. 10 percent of the total bid

Within 30 days of the last working day placement of hot mix asphalt, do the following:

1. Process and resolve all claims reported or submitted to you by the public as follows:
 - 1.1. Within 3 business days of receipt of a claim, submit to the Department a copy of the claim, a written analysis of the claim, and a statement indicating whether or not you will pay the claim. If you reject a claim, provide the reasons for rejection in writing.
 - 1.2. If the claimant becomes dissatisfied with your handling of the claim, immediately refer the claimant to the local district claims office for assistance in resolving the claim.
2. Submit to the Department evidence of your paid claims.

All claims presented to the Department, (Govt Code § 900 et seq.) are processed and resolved by the Department as follows:

1. The claims are processed as formal government claims subject to all laws and policies and are resolved as the Department determines including referring the claim to you for handling.
2. If the Department approves settlement of a claim or is ordered to pay pursuant to a court order, the claim is paid from funds withheld from you.
3. Within 3 business days of the Department's determination that you are responsible for resolving the claim, the Department sends a copy of the claim to you for resolution or notifies you of the Department's decision to resolve the claim.

The Department withholds an amount not to exceed 5 percent of the total bid to resolve all claims. The amount is held no longer than 60 days following the last working day so that the Department has ample time to resolve any pending claims. After 60 days, any remaining amount withheld is returned to you.

If no withheld funds remain or have been returned, the Department may pay any claims and seek reimbursement from you through an offset or any other legal means. Any reimbursement or offset to be recovered from you, including all other paid claims, is limited to 10 percent of the total bid.

Section 7-1.07C does not limit your obligation to defend and indemnify the Department.

Add between the 1st and 2nd paragraphs of section 7-1.11A:

Comply with 46 CFR 381.7(a)–(b).

8 PROSECUTION AND PROGRESS

Replace the headings and paragraphs in Section 8 with:

8-1.01 GENERAL

Section 8 includes specifications related to prosecuting the Contract and work progress.

8-1.01A Work Hours

Perform all work on working days during daytime.

Plan work so that all construction operations performed each day, including cleanup of the project site, establishment of appropriate traffic control and any other work necessary for the safety of the public shall be completed within the daytime hours.

Do not perform work during nighttime unless approved by the Engineer

Request approval to work during nighttime in writing and include the appropriate traffic control plan(s) and work plan(s) which clearly identify all provisions for illuminating all portions of the work site, including any flagging operations.

If you fail to complete work during the daytime hours, the Engineer may stop all work upon the onset of nighttime and order you to perform any and all work the Engineer deems necessary to ensure the safety of the public during the nighttime hours.

You are not entitled to any additional compensation or extension of the contract time as a result of the Engineer stopping the work due to the onset of nighttime.

8-1.02 SCHEDULE

8-1.02A General

Upon completion of all work, the Department returns the withholds associated with section 8-1.02 and makes a payment adjustment for work not performed in the same manner as work-character changes.

8-1.02B Level 1 Critical Path Method Schedule

8-1.02B(1) General

No pay item is provided for Level 1 Critical Path Project Schedule. Payment is considered to be included in the various items of work.

Before or at the preconstruction conference, submit a CPM baseline schedule.

For each schedule, submit:

1. Plotted original, time-scaled network diagram on a sheet at least 8-1/2 by 11 inches with a title block and timeline
2. A electronic copy in PDF (Adobe Acrobat compatible) format via email to the Engineer.

8-1.02B(2) Schedule Format

On each schedule, show:

1. Planned and actual start and completion dates of each work activity, including applicable:
 - 1.1. Submittal development
 - 1.2. Submittal review and acceptance
 - 1.3. Material procurement
 - 1.4. Contract milestones and constraints
 - 1.5. Equipment and plant setup
 - 1.6. Interfaces with outside entities
 - 1.7. Erection and removal of falsework and shoring
 - 1.8. Test periods
 - 1.9. Major traffic stage change
 - 1.10. Final cleanup
2. Order that you propose to prosecute the work
3. Logical links between the time-scaled work activities
4. All controlling activities
5. Legible description of each activity
6. At least 1 predecessor and 1 successor to each activity except for project start and project end milestones
7. Duration of at least 1 working day for each activity
8. Start milestone date as the Contract approval date

8-1.02B(3) Updated Schedule

Submit a monthly updated schedule that includes the status of work completed to date and the work yet to be performed as planned.

You may include changes to updated schedules that do not alter a critical path or extend the scheduled completion date compared to the current schedule. Changes may include:

1. Adding or deleting activities
2. Changing activity constraints
3. Changing durations
4. Changing logic

If any proposed change in planned work would alter the critical path or extend the scheduled completion date, submit a revised schedule within 15 days of the proposed change.

8-1.02C–8-1.02F Reserved

8-1.03 PRECONSTRUCTION CONFERENCE

Attend a preconstruction conference with key personnel, including your assigned representative, at a time and location determined by the Engineer. Submit documents as required before the preconstruction conference.

Be prepared to discuss the topics and documents shown in the following table:

Topic	Document
Potential claim and dispute resolution	Potential claim forms
Contractor's representation	Assignment of Contractor's representative
DBE	Final utilization reports
Equipment	Equipment list
Labor compliance and equal employment opportunity	Job site posters and benefit and payroll reports
Material inspection	Notice of Materials to be Used form
Materials on hand	Request for Payment for Materials on Hand form
Measurements	--
Partnering	--
Quality control	QC plans
Safety	Injury and Illness Prevention Program and job site posters
Schedule	Baseline schedule and Weekly Statement of Working Days form
Subcontracting	Subcontracting Request form
Surveying	Survey Request form
Traffic control	Traffic contingency plan and traffic control plans
Utility work	--
Weight limitations	--
Water pollution control	SWPPP or WPCP
Work restrictions	PLACs
Action submittals	--

8-1.04 START OF JOB SITE ACTIVITIES

8-1.04A General

Provide signed contracts, bonds, and evidence of insurance timely as required.

This section, 8-1.04, "Start of Job Activities," does not modify remedies available to the Department should you fail to provide signed contracts bonds and insurance timely.

Submit a notice 72 hours before starting job site activities. If the project has more than 1 location of work, submit a separate notice for each location.

You may start job site activities before receiving notice of Contract approval if you:

1. Deliver the signed Contract, bonds, and evidence of insurance to the Department

2. Submit 72-hour notice
3. Obtain an encroachment permit from the Department
4. Are authorized by the Department to start
5. Perform work at your own risk
6. Perform work under the Contract

If the Contract is approved, work already performed that complies with the Contract is authorized.

If the Contract is not approved, leave the job site in a neat condition. If a facility has been changed, restore it to its former condition or an equivalent condition. The Department does not pay for the restoration.

8-1.04B Standard Start

Be prepared to begin work at the project site no later than the 20th business day after award of the Contract by the Department.

The Engineer may issue a notice to proceed as soon as the Contracts, including bonds and insurance certificates, have been approved.

Start work on the day shown in the notice to proceed, unless an early start has been approved.

The Engineer may issue a notice of commencement of contract time if you fail to provide Contracts, including bonds and insurance certificates or other required documents timely.

A notice of commencement of contract time does not authorize you to start work on the project site, but contract time begins to elapse on the date shown in the notice of commencement of contract time.

Complete work before the expiration of FIFTY (50) WORKING DAYS

from the date shown in said Notice to Proceed, or in the Notice of Commencement of Contract Time, whichever comes first.

Complete all work, including corrective work and punch list work, prior to the expiration of the allotted working days. Working days continue to accrue until corrective work and punch list work is completed and accepted.

Pay to the County of Fresno the sum of FOUR THOUSAND DOLLARS (\$4,000.00)

per day for each and every calendar day's delay in finishing the work, including corrective work and punch list work, in excess of the total number of working days prescribed above.

8-1.05 TIME

Contract time starts on the day specified in the notice to proceed or in the notice of commencement of contract time as described in section 8-1.04 or on the day you start job site activities, whichever occurs first.

Complete the work within the Contract time.

Meet each specified interim work completion date.

The Engineer issues a *Weekly Statement of Working Days* by the end of the following week.

The *Weekly Statement of Working Days* shows:

1. Working days and non-working days during the reporting week
2. Time adjustments
3. Work completion date computations, including working days remaining

4. Controlling activities

8-1.06 SUSPENSIONS

The Engineer may suspend work wholly or in part due to conditions unsuitable for work progress. Provide for public safety and a smooth and unobstructed passageway through the work zone during the suspension as specified in sections 7-1.03 and 7-1.04. Providing the passageway is force account work. The Department makes a time adjustment for the suspension due to a critical delay.

The Engineer may suspend work wholly or in part due to your failure to (1) fulfill the Engineer's orders, (2) fulfill a Contract part, or (3) perform weather-dependent work when conditions are favorable so that weather-related unsuitable conditions are avoided or do not occur. The Department may provide for a smooth and unobstructed passageway through the work during the suspension and deduct the cost from payments. The Department does not make a time adjustment for the suspension.

Upon the Engineer's order of suspension, suspend work immediately. Resume work when ordered.

8-1.07 DELAYS

8-1.07A General

To request a delay-related time or payment adjustment, submit an RFI.

8-1.07B Time Adjustments

The Department may make a time adjustment for a critical delay. The Engineer uses information from the schedule to evaluate requests for time adjustments.

To request an adjustment, submit a revised schedule showing the delay's effect on the controlling activity. If the delay has:

1. Occurred, submit records of the dates and what work was performed during the delayed activity
2. Not occurred, submit the expected dates or duration of the delayed activity

Update the schedule to the last working day before the start of the delay if ordered.

8-1.07C Payment Adjustments

The Department may make a payment adjustment for an excusable delay that affects your costs.

Only losses for idle equipment, idle workers, and moving or transporting equipment are eligible for delay-related payment adjustments.

The Engineer determines payment for idle time of equipment in the same manner as determinations are made for equipment used in the performance of force account work under section 9-1.04 with the following exceptions:

1. Delay factor in the *Labor Surcharge and Equipment Rental Rates* applies to each equipment rental rate.
2. Daily number of payable hours equals the normal working hours during the delay, not to exceed 8 hours per day.
3. Delay days exclude non-working days.
4. Markups are not added.

The Engineer determines payment adjustment for the idle workers under section 9-1.04B, but does not add markups.

The Engineer includes costs due to necessary extra moving or transporting of equipment.

The Department does not make a payment adjustment for overhead incurred during non-working days of additional construction seasons experienced because of delay.

8-1.08–8-1.09 RESERVED

8-1.10 LIQUIDATED DAMAGES

8-1.10A General

The Department specifies liquidated damages (Pub Cont Code § 10226). Liquidated damages, if any, accrue starting on the 1st day after the expiration of the working days through the day of Contract acceptance except as specified in sections 8-1.10B and 8-1.10C.

The Department withholds liquidated damages before the accrual date if the anticipated liquidated damages may exceed the value of the remaining work.

Liquidated damages are specified in section 8-1.04.

8-1.10B Failure to Complete Work Parts within Specified Times

The Department may deduct specified damages from payments for each day needed to complete a work part in excess of the time specified for completing the work part.

Damages for untimely completion of work parts may not be equal to the daily amount specified as liquidated damages for the project as a whole, but the Department does not simultaneously assess damages for untimely completion of work parts and for the whole work.

Damages accrue starting the 1st day after a work part exceeds the specified time through the day the specified work part is complete.

8-1.10C Failure to Complete Work Parts by Specified Dates

The Department may deduct specified damages from payments for each day needed to complete a work part in excess of the specified completion date for the work part.

Damages for untimely completion of a work part may not be equal to the daily amount specified as liquidated damages for the project as a whole, but the Department does not simultaneously assess damages for untimely completion of a work part and the whole work.

Damages accrue starting the 1st day after an unmet completion date through the day the work part is complete.

8-1.10D RESERVED

8-1.11–8-1.12 RESERVED

8-1.13 CONTRACTOR'S CONTROL TERMINATION

The Department may terminate your control of the work for failure to do any of the following (Pub Cont Code § 10253):

1. Supply an adequate workforce
2. Supply material as described
3. Pay subcontractors (Pub Cont Code §10262)
4. Prosecute the work as described in the Contract

The Department may also terminate your control for failure to maintain insurance coverage.

For a federal-aid project, the Department may terminate your control of the work for failure to include "Required Contract Provisions, Federal-Aid Construction Contracts" in subcontracts.

The Department gives notice to you and your surety at least 5 business days before terminating control. The notice describes the failures and the time allowed to remedy the failures. If failures are not remedied within the time provided, the Department takes control of the work.

The Department may complete the work if the Department terminates the Contractor's control or you abandon the project (Pub Cont Code § 10255). The Department determines the unpaid balance under Pub Cont Code § 10258 and the Contract.

At any time before final payment of all claims, the Department may convert a Contractor's control termination to a Contract termination.

8-1.14 CONTRACT TERMINATION

8-1.14A General

The Director may terminate the Contract if it serves the County's best interest. The Department issues you a written notice, implements the termination, and pays you.

8-1.14B Relief from Responsibility for Work

Upon receiving a termination notice:

1. Stop work
2. Notify subcontractors and suppliers of the Contract termination and stop Contract-related work
3. Perform the Engineer-ordered work to secure the job site for termination
4. Remove equipment
5. Subject to the Engineer's authorization, settle termination-related claims and liabilities involving subcontractors and suppliers; assign to the Department the rights, titles, or interests held by you with respect to these parties

8-1.14C Responsibility for Materials

Upon receiving a termination notice, protect unused material until:

1. You submit an inventory of materials already produced, purchased, or ordered but not yet used; include the location of the material.
2. The Engineer identifies materials that will be retained by the Department. Submit bills of sales or other records of material title.
3. The Engineer confirms that unused materials paid by progress payment and materials furnished by the County have been delivered and stored as ordered.
4. The titles are transferred for materials purchased by the Department.

Dispose of materials that will not be retained by the Department.

8-1.14D Contract Acceptance after Termination

The Engineer recommends Contract acceptance after determining the completion of:

1. Work ordered to be completed before termination
2. Other work ordered to secure the project before termination
3. Material delivery and title transfer

The Department pays you under section 9-1.17.

8-1.14E Payment Adjustment for Termination

If the Department issues a termination notice, the Engineer determines the payment for termination based on the following:

1. Direct cost for the work:
 - 1.1. Including:
 - 1.1.1. Mobilization.
 - 1.1.2. Demobilization.
 - 1.1.3. Securing the job site for termination.
 - 1.1.4. Losses from the sale of materials.
 - 1.2. Not including:
 - 1.2.1. Cost of materials you keep.
 - 1.2.2. Profit realized from the sale of materials.
 - 1.2.3. Cost of material damaged by:
 - 1.2.3.1. Act of God.
 - 1.2.3.2. Act of a public enemy.

- 1.2.3.3. Fire.
 - 1.2.3.4. Flood.
 - 1.2.3.5. Governor-declared state of emergency.
 - 1.2.3.6. Landslide.
 - 1.2.3.7. Tsunami.
 - 1.2.4. Other credits.
2. Cost of remedial work, as estimated by the Engineer, is not reimbursed.
 3. Allowance for profit not to exceed 4 percent of the cost of the work. Prove a likelihood of having made a profit had the Contract not been terminated.
 4. Material handling costs for material returned to the vendor or disposed of as ordered.
 5. Costs in determining the payment adjustment due to the termination, excluding attorney fees and litigation costs.

Termination of the Contract does not relieve the surety of its obligation for any just claims arising out of the work performed.

8-1.15–8-1.16 RESERVED

9 PAYMENT

Add Section 9-1.01A:

9-1.01A COMPENSATION

The bid items shown in the bid item list represent full compensation for performing all work. Full compensation for any work for which there is no bid item shall be considered to be included in the various items of work.

Replace Section 9-1.03 with:

9-1.03 PAYMENT SCOPE

The Department pays you for furnishing the resources and activities required to complete the work. The Department's payment is full compensation for furnishing the resources and activities, including:

1. Risk, loss, damage repair, or cost of whatever character arising from or relating to the work and performance of the work
2. PLACs and taxes
3. Any royalties and costs arising from patents, trademarks, and copyrights involved in the work

The Department does not pay for your loss, damage, repair, or extra costs of whatever character arising from or relating to the work that is a direct or indirect result of your choice of construction methods, materials, equipment, or manpower, unless specifically mandated by the Contract.

Payment is:

1. Full compensation for all work involved in each bid item shown on the Bid Item List by the unit of measure shown for that bid item
2. For the price bid for each bid item shown on the Bid Item List or as changed by change order with a specified price adjustment

Full compensation for work specified in divisions I, II, and X is included in the payment for the bid items unless:

1. Bid item for the work is shown on the Bid Item List
2. Work is specified as change order work

Work paid for under one bid item is not paid for under any other bid item.

Payment for a bid item includes payment for work in sections referenced by the section set forth by that bid item.

Notwithstanding anything to the contrary in these special provisions, full compensation for performing all work as shown, as specified, and as directed by the Engineer is considered to be included in the various bid items, and no additional payment will be made, except pursuant to a contract change order to perform work not shown and/or specified.

If one or more bid item(s) is/are not included, perform the work as shown and as specified and payment therefor is considered to be included in the various items of work.

If an alternative is described in the Contract, the Department pays based on the bid items for the details and specifications not described as an alternative unless the bid item is described as an alternative, in which case, the Department pays based on the details and specifications for that alternative.

The Department pays for change order work based on one or a combination of the following:

1. Bid item prices
2. Force account
3. Agreed price
4. Specialist billing

If the Engineer chooses to pay for change order work based on an agreed price, but you and the Engineer cannot agree on the price, the Department pays by force account.

If a portion of extra work is covered by bid items, the Department pays for this work as changed quantities in those items. The Department pays for the remaining portion of the extra work by force account or agreed price.

If the amount of a deduction or withhold exceeds final payment, the Department invoices you for the difference, to be paid upon receipt.

Pay your subcontractors within 10 days of receipt of each progress payment under Pub Cont Code §§ 10262 and 10262.5.

9-1.07 PAYMENT ADJUSTMENTS FOR PRICE INDEX FLUCTUATIONS

9-1.07A General

Section 9-1.07 applies to asphalt contained in materials for pavement structures and pavement surface treatments such as HMA, tack coat, asphaltic emulsions, bituminous seals, asphalt binders, and modified asphalt binders placed in the work. Section 9-1.07 does not apply if you opted out of payment adjustments for price index fluctuations at the time of bid.

The Engineer adjusts payment whenever the California statewide crude oil price index for the month the material is placed is more than 5 percent higher or lower than the price index at the time of bid.

The California Department of Transportation determines the California statewide crude oil price index each month on or about the 1st business day of the month using the average of the posted prices in effect for the previous month as posted by Chevron, ExxonMobil, and ConocoPhillips for the Buena Vista and Midway Sunset fields.

If a company discontinues posting its prices for a field, the Department determines the index from the remaining posted prices. The Department may include additional fields to determine the index.

For the California statewide crude oil price index, go to the California Department of Transportation Division of Construction Web site.

If the adjustment is a decrease in payment, the Department deducts the amount from the monthly progress payment.

The Department makes payment adjustments due to price index fluctuations for changed quantities under section 9-1.06.

If you do not complete the work within the Contract time, payment adjustments during the overrun period are determined using the California statewide crude oil price index in effect for the month in which the overrun period began.

If the price index at the time of placement increases:

1. 50 percent or more over the price index at bid opening, notify the Engineer.
2. 100 percent or more over the price index at bid opening, do not furnish material containing asphalt until the Engineer authorizes you to proceed with that work. The Department may decrease bid item quantities, eliminate bid items, or terminate the Contract.

Before placing material containing asphalt, submit the current sales and use tax rate in effect in the tax jurisdiction where the material is to be placed.

Submit a public weighmaster's certificate for HMA, tack coat, asphaltic emulsions, and modified asphalt binders, including those materials not paid for by weight. For slurry seals, submit a separate public weighmaster's certificate for the asphaltic emulsion.

Replace Section 9-1.16F with:

9-1.16F Retentions

The Department, once in each month, shall cause an estimate in writing to be made by the Engineer. The estimate shall include the total amount of work done and acceptable materials furnished, provided the acceptable materials are listed as eligible for partial payment as materials in the special provisions and are furnished and delivered by the Contractor on the ground and not used or are furnished and stored for use on the contract, if the storage is within the State of California and the Contractor furnishes evidence satisfactory to the Engineer that the materials are stored subject to or under the control of the Department, to the time of the estimate, and the value thereof. The estimate shall also include any amounts payable for mobilization. Daily extra work reports furnished by the Contractor less than 5 calendar days, not including Saturdays, Sundays and legal holidays, before the preparation of the monthly progress estimate shall not be eligible for payment until the following month's estimate.

The amount of any material to be considered in making an estimate will in no case exceed the amount thereof which has been reported by the Contractor to the Engineer on Department-furnished forms properly filled out and executed, including accompanying documentation as therein required, less the amount of the material incorporated in the work to the time of the estimate. Only materials to be incorporated in the work will be considered. The estimated value of the material established by the Engineer will in no case exceed the contract price for the item of work for which the material is furnished.

The Department shall retain 5 percent of the estimated value of the work done and 5 percent of the value of materials so estimated to have been furnished and delivered and unused or furnished and stored as aforesaid as part security for the fulfillment of the contract by the Contractor. The Department will not hold retention for mobilization or demobilization.

The Department shall pay monthly to the Contractor, while carrying on the work, the balance not retained, as aforesaid, after deducting therefrom all previous payments and all sums to be kept or retained under the provisions of the contract. No monthly estimate or payment shall be required to be made when, in the judgment of the Engineer, the work is not proceeding in accordance with the provisions of the contract.

No monthly estimate or payment shall be construed to be an acceptance of any defective work or improper materials.

Attention is directed to the prohibitions and penalties pertaining to unlicensed contractors as provided in Business and Professions Code Sections 7028.15(a) and 7031.

Add Section 9-1.23:

9-1.23 RESOLUTION OF CONTRACT CLAIMS

Public works contract claims of three hundred seventy-five thousand dollars (\$375,000) or less which arise between a Contractor and a local public agency shall be resolved in accordance with the provisions of California Public Contract Code Sections 20104-20104.6, inclusive. In addition, California Public Contract Code Section 9204 requires that the procedure established therein shall apply to all claims (as therein defined) filed by a contractor in connection with a public works project. Accordingly, this contract expressly incorporates all of the terms and conditions of those statutory provisions, which are as follows:

California Public Contract Code Section 9204

(a) The Legislature finds and declares that it is in the best interests of the state and its citizens to ensure that all construction business performed on a public works project in the state that is complete and not in dispute is paid in full and in a timely manner.

(b) Notwithstanding any other law, including, but not limited to, Article 7.1 (commencing with Section 10240) of Chapter 1 of Part 2, Chapter 10 (commencing with Section 19100) of Part 2, and Article 1.5 (commencing with Section 20104) of Chapter 1 of Part 3, this section shall apply to any claim by a contractor in connection with a public works project.

(c) For purposes of this section:

(1) "Claim" means a separate demand by a contractor sent by registered mail or certified mail with return receipt requested, for one or more of the following:

(A) A time extension, including, without limitation, for relief from damages or penalties for delay assessed by a public entity under a contract for a public works project.

(B) Payment by the public entity of money or damages arising from work done by, or on behalf of, the contractor pursuant to the contract for a public works project and payment for which is not otherwise expressly provided or to which the claimant is not otherwise entitled.

(C) Payment of an amount that is disputed by the public entity.

(2) "Contractor" means any type of contractor within the meaning of Chapter 9 (commencing with Section 7000) of Division 3 of the Business and Professions Code who has entered into a direct contract with a public entity for a public works project.

(3)(A) "Public entity" means, without limitation, except as provided in subparagraph (B), a state agency, department, office, division, bureau, board, or commission, the California State University, the University of California, a city, including a charter city, county, including a charter county, city and county, including a charter city and county, district, special district, public authority, political subdivision, public corporation, or nonprofit transit corporation wholly owned by a public agency and formed to carry out the purposes of the public agency.

(B) "Public entity" shall not include the following:

(i) The Department of Water Resources as to any project under the jurisdiction of that department.

(ii) The Department of Transportation as to any project under the jurisdiction of that department.

(iii) The Department of Parks and Recreation as to any project under the jurisdiction of that department.

(iv) The Department of Corrections and Rehabilitation with respect to any project under its jurisdiction pursuant to Chapter 11 (commencing with Section 7000) of Title 7 of Part 3 of the Penal Code.

(v) The Military Department as to any project under the jurisdiction of that department.

(vi) The Department of General Services as to all other projects.

(vii) The High-Speed Rail Authority.

(4) "Public works project" means the erection, construction, alteration, repair, or improvement of any public structure, building, road, or other public improvement of any kind.

(5) "Subcontractor" means any type of contractor within the meaning of Chapter 9 (commencing with Section 7000) of Division 3 of the Business and Professions Code who either is in direct contract with a contractor or is a lower tier subcontractor.

(d) (1) (A) Upon receipt of a claim pursuant to this section, the public entity to which the claim applies shall conduct a reasonable review of the claim and, within a period not to exceed 45 days, shall provide the claimant a written statement identifying what portion of the claim is disputed and what portion is undisputed. Upon receipt of a claim, a public entity and a contractor may, by mutual agreement, extend the time period provided in this subdivision.

(B) The claimant shall furnish reasonable documentation to support the claim.

(C) If the public entity needs approval from its governing body to provide the claimant a written statement identifying the disputed portion and the undisputed portion of the claim, and the governing body does not meet within the 45 days or within the mutually agreed to extension of time following receipt of a claim sent by registered mail or certified mail, return receipt requested, the public entity shall have up to three days following the next duly publicly noticed meeting of the governing body after the 45-day period, or extension, expires to provide the claimant a written statement identifying the disputed portion and the undisputed portion.

(D) Any payment due on an undisputed portion of the claim shall be processed and made within 60 days after the public entity issues its written statement. If the public entity fails to issue a written statement, paragraph (3) shall apply.

(2) (A) If the claimant disputes the public entity's written response, or if the public entity fails to respond to a claim issued pursuant to this section within the time prescribed, the claimant may demand in writing an informal conference to meet and confer for settlement of the issues in dispute. Upon receipt of a demand in writing sent by registered mail or certified mail, return receipt requested, the public entity shall schedule a meet and confer conference within 30 days for settlement of the dispute.

(B) Within 10 business days following the conclusion of the meet and confer conference, if the claim or any portion of the claim remains in dispute, the public entity shall provide the claimant a written statement identifying the portion of the claim that remains in dispute and the portion that is undisputed. Any payment due on an undisputed portion of the claim shall be processed and made within 60 days after the public entity issues its written statement. Any disputed portion of the claim, as identified by the contractor in writing, shall be submitted to nonbinding mediation, with the public entity and the claimant sharing the associated costs equally. The public entity and claimant shall mutually agree to a mediator within 10 business days after the disputed portion of the claim has been identified in writing. If the parties cannot agree upon a mediator, each party shall select a mediator and those mediators shall select a qualified neutral third party to mediate with regard to the disputed portion of the claim. Each party shall bear the fees and costs charged by its respective mediator in connection with the selection of the neutral mediator. If mediation is unsuccessful, the parts of the claim remaining in dispute shall be subject to applicable procedures outside this section.

(C) For purposes of this section, mediation includes any nonbinding process, including, but not limited to, neutral evaluation or a dispute review board, in which an independent third party or board assists the parties in dispute resolution through negotiation or by issuance of an evaluation. Any mediation utilized shall conform to the timeframes in this section.

(D) Unless otherwise agreed to by the public entity and the contractor in writing, the mediation conducted pursuant to this section shall excuse any further obligation under Section 20104.4 to mediate after litigation has been commenced.

(E) This section does not preclude a public entity from requiring arbitration of disputes under private arbitration or the Public Works Contract Arbitration Program, if mediation under this section does not resolve the parties' dispute.

(3) Failure by the public entity to respond to a claim from a contractor within the time periods described in this subdivision or to otherwise meet the time requirements of this section shall result in the claim being deemed rejected in its entirety. A claim that is denied by reason of the public entity's failure to have responded to a claim, or its failure to otherwise meet the time requirements of this section, shall not constitute an adverse finding with regard to the merits of the claim or the responsibility or qualifications of the claimant.

(4) Amounts not paid in a timely manner as required by this section shall bear interest at 7 percent per annum.

(5) If a subcontractor or a lower tier subcontractor lacks legal standing to assert a claim against a public entity because privity of contract does not exist, the contractor may present to the public entity a claim on behalf of a subcontractor or lower tier subcontractor. A subcontractor may request in writing, either on his or her own behalf or on behalf of a lower tier subcontractor, that the contractor present a claim for work which was performed by the subcontractor or by a lower tier subcontractor on behalf of the subcontractor. The subcontractor requesting that the claim be presented to the public entity shall furnish reasonable documentation to support the claim. Within 45 days of receipt of this written request, the contractor shall notify the subcontractor in writing as to whether the contractor presented the claim to the public entity and, if the original contractor did not present the claim, provide the subcontractor with a statement of the reasons for not having done so.

(e) The text of this section or a summary of it shall be set forth in the plans or specifications for any public works project that may give rise to a claim under this section.

(f) A waiver of the rights granted by this section is void and contrary to public policy, provided, however, that (1) upon receipt of a claim, the parties may mutually agree to waive, in writing, mediation and proceed directly to the commencement of a civil action or binding arbitration, as applicable; and (2) a public entity may prescribe reasonable change order, claim, and dispute resolution procedures and requirements in addition to the provisions of this section, so long as the contractual provisions do not conflict with or otherwise impair the timeframes and procedures set forth in this section.

(g) This section applies to contracts entered into on or after January 1, 2017.

(h) Nothing in this section shall impose liability upon a public entity that makes loans or grants available through a competitive application process, for the failure of an awardee to meet its contractual obligations.

(i) This section shall remain in effect only until January 1, 2027, and as of that date is repealed, unless a later enacted statute, that is enacted before January 1, 2027, deletes or extends that date.

California Public Contract Code Sections 20104 – 20104.6

Section 20104

(a)(1) This article applies to all public works claims of three hundred seventy-five thousand dollars (\$375,000) or less which arise between a contractor and a local agency.

(2) This article shall not apply to any claims resulting from a contract between a contractor and a public agency when the public agency has elected to resolve any disputes pursuant to Article 7.1 (commencing with Section 10240) of Chapter 1 of Part 2.

(b)(1) "Public work" means "public works contract" as defined in Section 1101 but does not include any work or improvement contracted for by the state or the Regents of the University of California.

(2) "Claim" means a separate demand by the contractor for (A) a time extension, (B) payment of money or damages arising from work done by, or on behalf of, the contractor pursuant to the contract for a public work and payment of which is not otherwise expressly provided for or the claimant is not otherwise entitled to, or (C) an amount the payment of which is disputed by the local agency.

(c) The provisions of this article or a summary thereof shall be set forth in the plans or specifications for any work which may give rise to a claim under this article.

(d) This article applies only to contracts entered into on or after January 1, 1991.

Section 20104.2

For any claim subject to this article, the following requirements apply:

(a) The claim shall be in writing and include the documents necessary to substantiate the claim. Claims must be filed on or before the date of final payment. Nothing in this subdivision is intended to extend the time limit or supersede notice requirements otherwise provided by contract for the filing of claims.

(b) (1) For claims of less than fifty thousand dollars (\$50,000), the local agency shall respond in writing to any written claim within 45 days of receipt of the claim, or may request, in writing, within 30 days of receipt of the claim, any additional documentation supporting the claim or relating to defenses to the claim the local agency may have against the claimant.

(2) If additional information is thereafter required, it shall be requested and provided pursuant to this subdivision, upon mutual agreement of the local agency and the claimant.

(3) The local agency's written response to the claim, as further documented, shall be submitted to the claimant within 15 days after receipt of the further documentation or within a period of time no greater than that taken by the claimant in producing the additional information, whichever is greater.

(c) (1) For claims of over fifty thousand dollars (\$50,000) and less than or equal to three hundred seventy-five thousand dollars (\$375,000), the local agency shall respond in writing to all written claims within 60 days of receipt of the claim, or may request, in writing, within 30 days of receipt of the claim, any additional documentation supporting the claim or relating to defenses to the claim the local agency may have against the claimant.

(2) If additional information is thereafter required, it shall be requested and provided pursuant to this subdivision, upon mutual agreement of the local agency and the claimant.

(3) The local agency's written response to the claim, as further documented, shall be submitted to the claimant within 30 days after receipt of the further documentation, or within a period of time no greater than that taken by the claimant in producing the additional information or requested documentation, whichever is greater.

(d) If the claimant disputes the local agency's written response, or the local agency fails to respond within the time prescribed, the claimant may so notify the local agency, in writing, either within 15 days of receipt of the local agency's response or within 15 days of the local agency's failure to respond within the time

prescribed, respectively, and demand an informal conference to meet and confer for settlement of the issues in dispute. Upon a demand, the local agency shall schedule a meet and confer conference within 30 days for settlement of the dispute.

(e) Following the meet and confer conference, if the claim or any portion remains in dispute, the claimant may file a claim as provided in Chapter 1 (commencing with Section 900) and Chapter 2 (commencing with Section 910) of Part 3 of Division 3.6 of Title 1 of the Government Code. For purposes of those provisions, the running of the period of time within which a claim must be filed shall be tolled from the time the claimant submits his or her written claim pursuant to subdivision (a) until the time that claim is denied as a result of the meet and confer process, including any period of time utilized by the meet and confer process.

(f) This article does not apply to tort claims and nothing in this article is intended nor shall be construed to change the time periods for filing tort claims or actions specified by Chapter 1 (commencing with Section 900) and Chapter 2 (commencing with Section 910) of Part 3 of Division 3.6 of Title 1 of the Government Code.

Section 20104.4

The following procedures are established for all civil actions filed to resolve claims subject to this article:

(a) Within 60 days, but no earlier than 30 days, following the filing or responsive pleadings, the court shall submit the matter to nonbinding mediation unless waived by mutual stipulation of both parties. The mediation process shall provide for the selection within 15 days by both parties of a disinterested third person as mediator, shall be commenced within 30 days of the submittal, and shall be concluded within 15 days from the commencement of the mediation unless a time requirement is extended upon a good cause showing to the court or by stipulation of both parties. If the parties fail to select a mediator within the 15-day period, any party may petition the court to appoint the mediator.

(b) (1) If the matter remains in dispute, the case shall be submitted to judicial arbitration pursuant to Chapter 2.5 (commencing with Section 1141.10) of Title 3 of Part 3 of the Code of Civil Procedure, notwithstanding Section 1141.11 of that code. The Civil Discovery Act (Title 4 (commencing with Section 2016.010) of Part 4 of the Code of Civil Procedure) shall apply to any proceeding brought under this subdivision consistent with the rules pertaining to judicial arbitration.

(2) Notwithstanding any other provision of law, upon stipulation of the parties, arbitrators appointed for purposes of this article shall be experienced in construction law, and, upon stipulation of the parties, mediators and arbitrators shall be paid necessary and reasonable hourly rates of pay not to exceed their customary rate, and such fees and expenses shall be paid equally by the parties, except in the case of arbitration where the arbitrator, for good cause, determines a different division. In no event shall these fees or expenses be paid by state or county funds.

(3) In addition to Chapter 2.5 (commencing with Section 1141.10) of Title 3 of Part 3 of the Code of Civil Procedure, any party who after receiving an arbitration award requests a trial de novo but does not obtain a more favorable judgment shall, in addition to payment of costs and fees under that chapter, pay the attorney's fees of the other party arising out of the trial de novo.

(c) The court may, upon request by any party, order any witnesses to participate in the mediation or arbitration process.

Section 20104.6

(a) No local agency shall fail to pay money as to any portion of a claim which is undisputed except as otherwise provided in the contract.

(b) In any suit filed under Section 20104.4, the local agency shall pay interest at the legal rate on any arbitration award or judgment. The interest shall begin to accrue on the date the suit is filed in a court of law.

Add Section 9-1.24:

9-1.24 SUPPLEMENTAL WORK (PAYMENT ADJUSTMENTS FOR PRICE INDEX FLUCTUATIONS)

This item is provided solely to provide funds necessary for adjustments to the prices of those oil-containing materials expressly specified as eligible for such adjustments in "Payment Adjustments for Price Index Fluctuations," elsewhere in these special provisions.

The amount included for this item is an estimate only, and is a predetermined amount included in the bid item list(s) for the project.

This item, "Supplemental Work (Payment Adjustments for Price Index Fluctuations)" is purely administrative in nature, is not intended to limit such payment adjustments to the number provided in the bid item list(s), nor is it intended to modify or supplement the provisions in "Payment Adjustments for Price Index Fluctuations," in any manner whatsoever. Any and all such adjustments shall be made in strict conformance with the requirements in said section.

The provisions in Section 9-1.06, "Changed Quantity Pay Adjustments" of the Standard Specifications shall not apply to the item "Supplemental Work (Payment Adjustments for Price Index Fluctuations)."

Add Section 9-1.25:

9-1.25 SUPPLEMENTAL WORK

The Supplemental Work bid item is provided to compensate the Contractor for new and unforeseen work necessary to construct the project as designed and intended. Supplemental Work is not for design changes. Supplemental Work will be classed as extra work in accordance with the provisions of Section 4-1.05, "Changes and Extra Work," of the Standard Specifications. The dollar amount for supplemental work shown in the Proposal is an estimate only, and shall be included in each bidder's proposal.

Supplemental work shall be performed only upon direct written authorization from the Engineer and daily extra work reports shall be submitted to and approved by the Engineer. The contractor shall maintain separate records for extra work performed in accordance with the provisions of Section 5-1.27, "Records," of the Standard Specifications and these special provisions.

Payment will be based on the total amount of authorized Supplemental Work actually performed. The provisions in Section 9-1.06, "Changed Quantity Pay Adjustments" of the Standard Specifications shall not apply to the item "Supplemental Work."

DIVISION II GENERAL CONSTRUCTION

10 GENERAL

Replace *Reserved* in Section 10-1.02A

The Contractor shall complete all Bituminous Seal Coat works on the east side of State Highway 99 prior to beginning work on the west side of State Highway 99.

12 TEMPORARY TRAFFIC CONTROL

Replace section 12-1.04 with:

12-1.04 FLAGGING COSTS

You pay the cost of furnishing all flaggers, including transporting flaggers and furnishing stands and towers for flaggers to provide for the passage of traffic through the work as specified in sections 7-1.03 and 7-1.04.

Replace section Section 12-2 with:

12-2 CONSTRUCTION ADVANCED NOTIFICATION SIGNS (ANS)

12-2.01 GENERAL

Details for construction ANS are in *Project Details*.

Keep ANS clean and in good repair at all times.

12-2.02 MATERIALS

Provide ANS, posts, and mounting hardware.

Construction ANS must be wood post signs complying with section 82-3.

Sign panels must be framed, single sheet aluminum panels complying with section 82-2.

The background on construction project funding signs must be Type II retroreflective sheeting on the Authorized Material List for signing and delineation materials.

The legend must be retroreflective, except for nonreflective black letters and numerals. The colors blue and orange must comply with PR Color no. 3 and no. 6, respectively, as specified in the Federal Highway Administration's *Color Tolerance Chart*.

12-2.03 CONSTRUCTION

Provide and Install construction ANS at the locations designated by the Engineer 7 days before starting major work activities visible to highway users.

Upon completion and acceptance of the work, the signs shall be removed and become the property of the Contractor.

12-2.04 PAYMENT

The Department pays you for construction ANS as follows:

1. 75 percent of the item upon installation of each sign
2. 100 percent of the item upon removal of each sign

Replace Section 12-3.01C with:

12-3.01C Construction

If channelizing devices are used on the project, perform all layout work necessary to place channelizing devices:

1. On the proper alignment
2. Uniformly at the location and spacing described
3. Straight on a tangent alignment
4. On a true arc in a curved alignment

If temporary traffic control devices are damaged, displaced, or stop operating or functioning as described from any cause during the progress of the work, immediately repair, repaint, or replace the components and restore them to their original locations and positions.

If ordered, furnish and place additional temporary traffic control devices. This work is not change order work if:

1. Required to conform with your traffic control plan
2. Required to conform with the MUTCD
3. Necessary for public safety or convenience as determined by the Engineer
4. Required to perform staged construction shown on the plans

Replace Section 12-3.03C with:

12-3.03C Construction

If plastic traffic drums are used on project, use 1 type of plastic traffic drum on the project.

Use the same type and brand of retroreflective sheeting for all plastic traffic drums used on the project.

Do not use sandbags or comparable ballast.

Moving plastic traffic drums from location to location if ordered after initial placement is not change order work if:

1. Required to conform with your traffic control plan
2. Required to conform with the MUTCD
3. Necessary for public safety or convenience as determined by the Engineer
4. Required to perform staged construction shown on the plans

Replace Section 12-3.10C with:

12-3.10C Construction

If barricades are used on the project, place each barricade such that the stripes slope downward in the direction road users are to pass.

Place each sand-filled bag near the ground level on the lower parts of the frame or stays to serve as ballast for the barricades. Do not place ballast on top of barricades or over any retroreflective barricade rail face that is facing traffic.

Do not remove barricades that are shown to be left in place at the time of work completion.

Moving a barricade from location to location is change order work if ordered after initial placement of the barricade unless.

1. Required to conform with your traffic control plan
2. Required to conform with the MUTCD
3. Necessary for public safety or convenience as determined by the Engineer
4. Required to perform staged construction shown on the plans

Replace Section 12-3.20C(1) with:

12-3.20C1 General

If Type K temporary rail is used on the project, before placing Type K temporary railing on the job site, paint the exposed surfaces of the railing with white paint complying with the specifications for acrylic emulsion paint for exterior masonry.

Place Type K temporary railing on a firm, stable foundation. Grade the foundation to provide a uniform bearing surface throughout the entire length of the railing.

Structure excavation and backfill must comply with section 19-3 except compaction of earth fill placed behind Type K temporary railing in a curved layout is not required.

Place and maintain the abutting ends of PC concrete units in alignment without substantial offset from each other.

The drilling of holes and bonding of threaded rods or dowels must comply with the specifications for drilling and bonding dowels in section 51-1.

Install a reflector on the top or face of the rail of each rail unit placed within 10 feet of a traffic lane. Apply adhesive for mounting the reflector under the reflector manufacturer's instructions.

Install a Type P marker panel at each end of railing placed adjacent to a 2-lane, two-way highway and at the end facing traffic for railing installed adjacent to a one-way roadbed. If the railing is placed on a skew, install the marker at the end of the skew nearest the traveled way. Type P marker panels must comply with section 82 except you must furnish the marker panels.

After removing Type K temporary railing:

1. Restore the area to its previous condition or construct it to its planned condition if temporary excavation or embankment was used to accommodate the railing.
2. Remove all threaded rods or dowels to a depth of at least 1 inch below the surface of the concrete. Fill the resulting holes with mortar under section 51-1 except cure the mortar by the water method or by the curing compound method using curing compound no. 6.

If the Engineer orders a lateral move of Type K temporary railing and repositioning is not shown, the lateral move is change order work unless:

1. Required to conform with your traffic control plan
2. Required to conform with the MUTCD
3. Necessary for public safety or convenience as determined by the Engineer
4. Required to perform staged construction shown on the plans

Replace Section 12-3.22C with:

12-3.22C Construction

If crash cushion modules are used on the project, use the same type of crash cushion module for a single grouping or array.

Temporary crash cushion arrays must not encroach on the traveled way.

Secure the sand-filled modules in place before starting an activity requiring a temporary crash cushion.

Maintain sand-filled temporary crash cushions in place at each location, including times when work is not actively in progress. You may remove the crash cushions during the work shift for access to the work if the exposed fixed obstacle is 15 feet or more from the nearest lane carrying traffic. Reset the crash cushion before the end of the work shift.

Immediately repair sand-filled temporary crash cushion modules damaged due to your activities. Remove and replace any module damaged beyond repair. Repair and replacement of temporary crash cushion modules damaged by traffic are change order work.

You may place sand-filled temporary crash cushion modules on movable pallets or frames complying with the dimensions shown. The pallets or frames must provide a full-bearing base beneath the modules. Do not move the modules and supporting pallets or frames by sliding or skidding along the pavement or bridge deck.

Attach a Type R or Type P marker panel to the front of the temporary crash cushion if the closest point of the crash cushion array is within 12 feet of the traveled way. Firmly fasten the marker panel to the crash cushion with commercial quality hardware or by other authorized methods. Attach the Type R marker panel such that the top of the panel is 1 inch below the module lid. Attach the Type P marker panel such that the bottom of the panel rests upon the pallet or roadway surface if pallets are not used.

A lateral move of a temporary crash cushion module is change order work if ordered and the repositioning is not shown, unless required for staged construction.

Remove sand-filled temporary crash cushion modules, including sand, pallets or frames, and marker panels, at Contract acceptance. Do not install sand-filled temporary crash cushion modules in the permanent work.

Replace section 12-3.31C with:

12-3.31C Construction

If portable flashing beacons are used on the project, remove portable flashing beacons from the traveled way at the end of each night's work. You may store the flashing beacon at selected central locations within the highway where designated by the Engineer.

Moving portable flashing beacons from location to location if ordered after initial placement is change order work unless:

1. Required to conform with your traffic control plan
2. Required to conform with the MUTCD
3. Necessary for public safety or convenience as determined by the Engineer
4. Required to perform staged construction shown on the plans

Add to section 12-3.32C:

Start displaying the message ("ROADWORK START MONTH/DAY/YEAR" "EXPECT DELAYS") on the portable changeable message boards 7 days prior to the start of construction.

Start displaying the message on the portable changeable message sign 10 minutes before closing the lane.

Place the portable changeable message sign in advance of the 1st warning sign for each:

1. Stationary lane closure
2. Connector closure
3. Shoulder closure
4. Speed reduction zone

Replace Section 12-3.35B(6) with:

12-3.35B(6) User Interface

If the project includes an AWIS, the system must have a user interface to control the AWIS PCMS communications. The interface must be (1) software compatible with a Windows environment or (2) a web service accessed by a web browser.

Provide any software on a CD or other Engineer-authorized data-storage device.

The user interface must, at a minimum, provide the user with a list of AWIS PCMSs in the field, location information for each AWIS PCMS, and a real-time on-board display of the message in the field. Control options must, at a minimum, provide the user the ability to change the on-board messages and flash rate.

**Replace Section 12-4 with:
12-4 MAINTAINING TRAFFIC**

12-4.01 GENERAL

12-4.01A General

Section 12-4.01 includes general specifications for maintaining traffic through construction work zones.

If local authorities regulate traffic, notify them at least 5 business days before the start of job site activities. Cooperate with the local authorities to handle traffic through the work zone and to make arrangements to keep the work zone clear of parked vehicles.

12-4.01B Materials

Not Used

12-4.01C CONSTRUCTION

Furnishing and operating pilot cars is not change order work.

12-4.01D Payment

Not Used

12-4.02 TRAFFIC CONTROL SYSTEMS

12-4.02A General

12-4.02A(1) Summary

Section 12-4.02 includes specifications for providing a traffic control system to close traffic lanes, shoulders, and roadways.

A traffic control system for a closure includes the temporary traffic control devices described as part of the traffic control system. Temporary traffic control devices must comply with section 12-3.

12-4.02A(2) Definitions

designated holidays: Designated holidays are shown as "holidays" in Section 1-1.07B.

12-4.02A(3) Submittals

12-4.02A(3)(a) General

The Contractor shall prepare and submit to the County Construction Engineer for approval, a traffic control system plan indicating the means and methods he will employ to institute and maintain traffic control for all phases of the work within the project. The traffic control system plan shall be submitted to the County Construction Engineer as early as possible, preferably **five (5) working days** prior to pre-construction meeting. The Engineer will require five (5) working days to review the initial submittal of the traffic control system plan and an additional five (5) working days for each successive review.

No work at the project site whatsoever, including preparatory work such as the installation of construction project funding signs, shall commence until the traffic control system plan has been approved in writing by the Engineer. In the event that the traffic control system plan is not submitted timely, the Engineer may issue a notice of commencement of contract time prior to approval of the traffic control system plan, and working days will begin to accrue against the allotted contract time.

Late submittal of the traffic control plan or revisions thereafter required, due to the inadequacy of the plan, shall not be accepted as justification for the delay in the start of the working days for the project.

It shall be the Contractor's responsibility to provide, install, maintain, and remove any and all detour signage and traffic control devices and to obtain all permits, including permits from Caltrans, as may be necessary to establish detours as part of the contractor's traffic control plan.

Traffic will not be allowed to be limited to one direction when construction activities are not actively in progress. Providing, installing, maintaining, and removing all traffic control, including portable changeable message signs if required, obtaining and complying with all permits, and providing all traffic control operations shall be the responsibility of the contractor, and no additional compensation will be allowed therefor.

12-4.02A(3)(b) Closure Schedules

One-way traffic shall be controlled through the project in accordance with the California Manual MUTCD and Caltrans Standard Plans T-11 and T-13 entitled "Traffic Control System for Lane Closure on Multilane Conventional Highways" and "Traffic Control System for Lane Closure on Two Lane Conventional Highways," and these special provisions. Night closure will not be permitted.

When traffic is under one way control on unpaved areas, the cones shown along the centerline on the plan need not be placed.

Every Monday by noon, submit a closure schedule request for planned closures for the next week.

The next week is defined as Sunday at noon through the following Sunday at noon.

Submit a closure schedule request 5 days before the anticipated start of any job site activity that reduces:

1. Horizontal clearances of traveled ways, including shoulders, to 2 lanes or fewer due to activities such as temporary barrier placement and paving
2. Vertical clearances of traveled ways, including shoulders, due to activities such as pavement overlays, overhead sign installation, or falsework girder erection

Submit closure schedule changes, including additional closures, by noon at least 3 business days before a planned closure.

Cancel closure requests at least 48 hours before the start time of the closure.

The Department notifies you of unauthorized closures or closures that require coordination with other parties as a condition for authorization.

12-4.02A(3)(c) Contingency Plans for Closures

Submit a contingency plan for an activity that could affect a closure if a contingency plan is specified in the special provisions or if a contingency plan is requested.

If a contingency plan is requested, submit the contingency plan within 1 business day of the request.

The contingency plan must identify the activities, equipment, processes, and materials that may cause a delay in the opening of a closure to traffic. The plan must include:

1. List of additional or alternate equipment, materials, or workers necessary to ensure continuing activities and on-time opening of closures if a problem occurs. If the additional or alternate equipment, materials, or workers are not on the job site, specify their location, the method for mobilizing these items, and the required time to complete mobilization.
2. General time-scaled logic diagram displaying the major activities and sequence of the planned activities. For each activity, identify the critical event that will activate the contingency plan.

Submit revisions to a contingency plan at least 3 business days before starting the activity requiring the contingency plan. Allow 2 business days for review.

12-4.02A(4) Quality Assurance

Reserved

12-4.02B Materials

Not Used

12-4.02C Construction

12-4.02C(1) General

Traffic will be controlled by flagmen by eyesight, radio (walkie talkie) or baton. In the event these methods do not work satisfactorily, as determined by the Engineer, a pilot car will be required.

The Engineer may require a pilot car to be used during earthwork operations in preparation of the grading plane or other operations when the Contractor's operations cover an area beyond the line of sight, or beyond the range of radios or when the baton method does not function satisfactorily.

Work that interferes with traffic is limited to the hours when closures are allowed.

For multilane freeway or expressway lane closures, do not place the 2L tangent section along lane lines between the lane closure tapers.

For multilane freeways and expressways, do not place the traffic cones to be placed transversely across closed traffic lanes and shoulders.

Additional advance flaggers are required.

For traffic under 1-way control on unpaved areas, the cones along the centerline need not be placed.

You may use a pilot car to control traffic. If a pilot car is used for traffic control, the cones along the centerline need not be placed. The pilot car must have radio contact with personnel in the work area. Operate the pilot car through the traffic control zone at a speed not greater than 25 miles per hour.

Use a pilot car to control traffic. The cones shown along the centerline need not be placed. The pilot car must have radio contact with personnel in the work area. Operate the pilot car through the traffic control zone at a speed not greater than 25 miles per hour.

12-4.02C(3) Closure Requirements and Charts

12-4.02C(3)(a) General

Where 2 or more lanes in the same direction, including the shoulders, are adjacent to the area where the work is being performed, close the adjacent lane under any of the following conditions:

1. Work is off the traveled way but within 6 feet of the edge of the traveled way, and the approach speed is greater than 45 mph
2. Work is off the traveled way but within 3 feet of the edge of the traveled way, and the approach speed is less than 45 mph

Closure of the adjacent traffic lane is not required during any of the following activities:

1. Work behind a barrier
2. Paving, grinding, or grooving
3. Installation, maintenance, or removal of traffic control devices except for temporary railing

12-4.02C(3)(b) - 12-4.02C(3)(n)

Reserved

12-4.02C(3)(o) Closure of Conventional County Roads

The type and location of signs, lights, flags, flagmen, and other traffic control and safety devices shall be in accordance with the current edition of the California Manual on Uniform Traffic Control Devices (MUTCD) issued by the State of California, Department of Transportation (Caltrans).

Public traffic shall be permitted to pass through construction at all times unless otherwise specified herein.

Provide access to properties abutting the project site at all times.

When directed by the Engineer, traffic shall be routed through the work under one-way control.

Under one-way reversing traffic control operations, public traffic may be stopped in one direction for periods not to exceed 10 minutes.

Lane closure is defined as the closure of a traffic lane or lanes within a single traffic control system.

A minimum of one paved traffic lane, not less than 10 feet wide, shall be open for use by public traffic at all times.

The full width of the traveled way shall be open for use by public traffic when construction operations are not actively in progress.

The Contractor's attention is directed to private driveways and access roads. The driveways and access roads shall remain accessible at all times.

The Contractor's attention is directed to the access roads adjacent to the project site. Vehicular access to the channel bank access roads shall be maintained at all times.

The seal coats shall not be applied to more than one-half of the width to be sealed at time, and the remaining half width to be kept free of obstructions and open for use by public traffic until the seal coat first applied is finished as per Section 37-2.01(c)(4)(d) ready for use by traffic.

Personal vehicles of the Contractor's employees shall not be parked on the traveled way or shoulders including sections closed to public traffic.

When work vehicles or equipment are parked on the shoulder within 6 feet of a traffic lane, the shoulder area shall be closed as shown on *Standard Plan T-10*.

The Contractor's equipment and materials shall not remain in a lane except when such lane is closed to traffic and the lane is being used for contract operations.

12-4.02C(3)(o)–12-4.02C(3)(s) Reserved

12-4.02C(4)–12.4.02C(6) Reserved

12-4.02C(7) Traffic Control System Requirements

12-4.02C(7)(a) General

Control traffic using stationary closures.

If components of the traffic control system are displaced or cease to operate or function as specified, immediately repair them to their original condition or replace them and place them back in their original locations.

Vehicles equipped with attenuators must comply with section 12-3.23.

Each vehicle used to place, maintain, and remove components of a traffic control system on a multilane highway must have a Type II flashing arrow sign that must operate whenever the vehicle is used for placing, maintaining, or removing the components. For a stationary closure, vehicles with a Type II flashing arrow sign not involved in placing, maintaining, or removing the components must display only the caution display mode. If a flashing arrow sign is required for a closure, activate the sign before the closure is in place.

12-4.02C(7)(b) Stationary Closures

Except for channelizing devices placed along open trenches or excavations adjacent to the traveled way, remove the components of the traffic control system for a stationary closure from the traveled way and shoulders at the end of each work period. You may store the components at authorized locations within the limits of the highway.

If a traffic lane is closed with channelizing devices for excavation work, move the devices to the adjacent edge of the traveled way when not excavating. Space the devices as shown for the lane closure.

12-4.02C(7)(c) Moving Closures

For a moving closure, use a PCMS that complies with section 12-3.32 except the sign must be truck mounted. The full operational height to the bottom of the sign may be less than 7 feet above the ground but must be as high as practicable.

If you use a flashing arrow sign in a moving closure, the sign must be truck mounted. Operate the flashing arrow sign in the caution display mode if it is being used on a 2-lane, two-way highway.

12-4.02C(8) Traffic Control System Signs

12-4.02C(8)(a) General

Traffic control system signs must comply with section 12-3.11.

12-4.02C(8)(b) Connector and Ramp Closure Signs

Inform motorists of a temporary closing of a (1) connector or a (2) freeway or expressway entrance or exit ramp using:

1. SC6-3(CA) (Ramp Closed) sign for closures of 1 day or less
2. SC6-4(CA) (Ramp Closed) sign for closures of more than 1 day

SC6-3(CA) and SC6-4(CA) signs must be stationary mounted at the locations shown and must remain in place and visible to motorists during the connector or ramp closure.

Notify the Engineer at least 2 business days before installing the sign and install the sign from 7 to 15 days before the closure.

12-4.02C(10)–12-4.02C(11) Reserved

12-4.02C(12) Failure to Provide Traffic Control.

If you do not provide the traffic control and it becomes necessary for the Engineer to notify you of your duties according to the Standard Specifications and these special provisions, you will pay \$200 per 15-minute period or portion thereof to the County for all the time required to acquire the traffic control, including pilot car.

Such payment shall commence at the time notice of the improper traffic control condition is given to you or your authorized representative by the Engineer and shall terminate when the condition is corrected. Such payment will be deducted from your payment.

In addition, when it is necessary for the Engineer to perform the work, you will pay the actual cost for the performance thereof. Such amount will be deducted from the your payment. This will be in addition to any penalties imposed in these special provisions.

The provisions in this section will not relieve you from your responsibility to provide such additional devices or take such measures as may be necessary to comply with the provisions in Section 7-1.04, "Public Safety," of the Standard Specifications.

12-4.02D Payment

The Department pays for change order work for a traffic control system by force account for increased traffic control and uses a force account analysis for decreased traffic control.

Traffic control system for lane closure is paid for as traffic control system. Flagging costs are paid for as specified in section 12-1.04.

The requirements in section 4-1.05 for payment adjustment do not apply to traffic control system. Adjustments in compensation for traffic control system will be made for an increase or decrease in traffic control work if ordered and will be made on the basis of the cost of the necessary increased or decreased traffic control. The adjustment will be made on a force account basis for increased work and estimated on the same basis in the case of decreased work.

A traffic control system required by change order work is paid for as a part of the change order work.

Full compensation for furnishing and operating the pilot car, (including driver, radios, and any other equipment and labor required) shall be considered as included in the contract lump sum price paid for traffic control system and no further payment will be made.

12-4.03 FALSEWORK OPENINGS

Reserved

12-4.04 PEDESTRIAN FACILITIES

12-4.04A General

Section 12-4.04 includes specifications for providing temporary pedestrian facilities.

Temporary pedestrian facilities must comply with section 16-2.02.

12-4.04B Materials

Not Used

12-4.04C Construction

If pedestrian traffic is allowed to pass through work areas, provide a temporary pedestrian facility through the construction areas within the highway. Include a protective overhead covering as necessary to ensure protection from falling objects and drippings from overhead structures.

If an activity requires a closure of a walkway, provide another walkway nearby, off of the traveled way.

Where pedestrian openings through falsework are required, provide a temporary pedestrian facility with a protective overhead covering during all bridge construction activities.

12-4.04D Payment

Not Used

Add to Section 12-7.02:

Temporary chip seal marker or other suitable temporary pavement marker can be used for temporary pavement marking as appropriate.

13 WATER POLLUTION CONTROL

Replace 13-1.01A with:

13-1.01A Summary

Section 13-1 includes general specifications for preventing, controlling, and abating water pollution within waters of the State.

Information on forms, reports, and other documents is in the following Caltrans manuals:

1. Field Guide to Construction Site Dewatering
2. Stormwater Pollution Prevention Plan (SWPPP) and Water Pollution Control Program (WPCP) Preparation Manual
3. Construction Site Best Management Practices (BMPs) Manual
4. Construction Site Monitoring Program Guidance Manual

You may view these manuals at the Stormwater and Water Pollution Control Information link at the Caltrans Division of Construction website or purchase them at the Caltrans Publication Distribution Unit.

A WPCP and a SWPPP must comply with the Caltrans Stormwater Pollution Prevention Plan (SWPPP) and Water Pollution Control Program (WPCP) Preparation Manual and must be prepared using the latest template posted on the Construction stormwater website.

Replace Section 13-1.01D(2) with:

13-1.01D(2) Regulatory Requirements

Comply with the discharge requirements in the NPDES General Permit for Storm Water Discharges Associated with Construction and Land Disturbance Activities; Order No. 2009-000 9-DWQ, CAS000002 (Construction General Permit) and any amendments thereto issued by the SWRCB. The Construction General Permit may be found at:

http://www.waterboards.ca.gov/water_issues/programs/stormwater/constpermits.shtml

Discharges from manufacturing facilities, such as batch plants and crushing plants, must comply with the discharge requirements in the NPDES General Permit for Storm Water Discharges Associated with Industrial Activities; Order No. 2014-0057-DWQ, CAS000001 (Industrial General Permit), issued by the SWRCB. For the Industrial General Permit, go to the SWRCB website.

For a batch plant and crushing plant outside a job site or within a job site that serves one or more contracts, obtain coverage under the Industrial General Permit before operating a batch plant to manufacture concrete, HMA, or other material or a crushing plant to produce rock or aggregate.

Replace Section 13-1.01D(4)(b) with:

13-1.01D(4)(b) Qualifications

The WPC manager must:

1. Comply with the requirements provided in the Construction General Permit for:
 - 1.1. QSP if the project requires a WPCP
 - 1.2. QSD if the project requires a SWPPP
2. Complete the stormwater management training described at the Stormwater and Water Pollution Control Information link at the Caltrans Division of Construction website

Replace Section 13-2.04:

13-2.04 PAYMENT

The Department pays for prepare water pollution control program as follows:

1. Total of 50 percent of the item total upon authorization of the WPCP
2. Total of 90 percent of the item total upon work completion
3. Total of 100 percent of the item total upon Contract acceptance

Add to section 13-3.01A:

This project's risk level is 1.

Add to Section 13-4.03C(3):

Temporary Cover is required for stockpile materials onsite that are left inactive for more than 14 days.

Add to Section 13-4.04:

Payment for stockpile management is included in the bid item for Temporary Cover, as applicable.

Replace Section 13-6.04 with:

13-6.04 PAYMENT

The payment quantity for temporary sediment control bid items paid for by the length is the length measured along the centerline of the installed material.

The payment quantity, if any, for temporary fiber roll does not include the additional quantity used for overlaps.

The Department does not pay for the relocation of temporary drainage inlet protection during work progress.

If there are no bid items for installing or maintaining temporary sediment control measures, payment therefor is considered to be included in the bid item for prepare water pollution control program or in the bid item for prepare stormwater pollution prevention plan, as applicable.

Replace Section 13-7.03D with:

13-7.03D Payment

The Department does not pay for the relocation of temporary construction entrances or roadways during work progress.

If there are no bid items for installing or maintaining temporary construction entrances or roadways, payment therefor is considered to be included in the bid item for prepare water pollution control program or in the bid item for prepare stormwater pollution prevention plan, as applicable.

DIVISION V SURFACINGS AND PAVEMENTS

36 GENERAL

Replace Section 36-3 with:

36-3 RESERVED

Replace Section 37 with:

37 SEAL COATS

37-1 GENERAL

37-1.01 GENERAL

37-1.01A Summary

Section 37-1 includes general specifications for applying seal coats.

37-1.01B Definitions

Reserved

37-1.01C Submittals

At least 10 days before the preconstruction meeting submit a list of participants in the preconstruction meeting. Provide each participant's name, employer, title, and role in the production and placement of the seal coats.

At least 10 days before starting seal coat activities, submit the names of the authorized laboratories for quality control testing.

For each delivery of asphalt binder or asphaltic emulsion to the job site, submit a certificate of compliance and a copy of the specified test results.

For a seal coat that uses crumb rubber modifier, submit a Crumb Rubber Usage Report form monthly and at the end of project.

37-1.01D Quality Assurance

37-1.01D(1) General

For aggregate testing, quality control laboratories must be in compliance with the Caltrans Independent Assurance Program to be an authorized laboratory. Quality control personnel must be qualified under the Caltrans Independent Assurance Program.

For emulsion testing, quality control laboratories must participate in the AASHTO Material's Reference Laboratory proficiency sample program. The lab must show evidence of a rating of three or greater on the two most recent samples.**37-1.01D(2) Preconstruction Meeting**

Hold a preconstruction meeting within 5 days before start of seal coat work at a mutually agreed time and place with the Engineer and your:

1. Project superintendent
2. Project foreman
3. Traffic control foreman

Make arrangements for the conference facility. Preconstruction meeting participants must sign an attendance sheet provided by the Engineer. Be prepared to discuss:

1. Quality control testing
2. Acceptance testing
3. Seal coat placement
4. Proposed application rates for asphaltic emulsion or asphalt binder and aggregate.
5. Training on placement methods
6. Checklist of items for proper placement
7. Unique issues specific to the project, including:
 - 7.1. Weather
 - 7.2. Alignment and geometrics
 - 7.3. Traffic control requirements
 - 7.4. Haul distances
 - 7.5. Presence and absence of shaded areas
 - 7.6. Any other local conditions
8. Contingency plan for material deliveries, equipment breakdowns, and traffic handling
9. Who in the field has authority to adjust application rates and how adjustments will be documented
10. Schedule of sweepings

37-1.02 MATERIALS

Not Used

37-1.03 CONSTRUCTION

37-1.03A General

If seal coat activities affect access to public parking, residential property, or commercial property, post signs at 100-foot intervals on the affected streets. Signs must display *No Parking – Tow Away*. Signs must state the dates and hours parking or access will be restricted. Notify residents, businesses, and local agencies at least 24 hours before starting activities. The notice must:

1. Describe the work to be performed
2. Detail streets and limits of activities
3. Indicate dates and work hours
4. Be authorized

Asphaltic emulsion or asphalt binder for seal coats may be reheated if necessary. After loading the asphaltic emulsion or asphalt binder into a truck for transport to the job site, do not heat asphaltic emulsion above 160 degrees F and asphalt rubber binder above 425 degrees F. During reheating, circulate or agitate the asphaltic emulsion or asphalt binder to prevent localized overheating.

Except for fog seals, apply quick setting Grade 1 asphaltic emulsions at a temperature from 75 to 130 degrees F and apply quick setting Grade 2 asphaltic emulsions at a temperature from 110 to 185 degrees F.

You determine the application rates for asphaltic emulsion or asphalt binder and aggregate and the Engineer authorizes the application rates.

37-1.03B Equipment

A self-propelled distributor truck for applying asphaltic emulsion or asphalt binder must be equipped with:

1. Pressure-type system with insulated tanks with circulating unit
2. Spray bars:
 - 2.1. With minimum length of 9 feet and full-circulating type
 - 2.2. With full-circulating-type extensions if needed to cover a greater width
 - 2.3. Adjustable to allow positioning at various heights above the surface to be treated
 - 2.4. Operated by levers such that 1 or all valves may be quickly opened or closed in one operation
3. Devices and charts to provide for accurate and rapid determination and control of asphaltic emulsion or asphalt binder quantities being applied. Include an auxiliary wheel type meter that registers:
 - 3.1. Speed in ft/min
 - 3.2. Trip by count
 - 3.3. Total distance in feet
4. Distribution system:
 - 4.1. Capable of producing a uniform application of asphaltic emulsion or asphalt binder in controlled quantities ranging from 0.02 to 1 gal/sq yd of surface and at a pressure ranging from 25 to 75 psi
 - 4.2. Pumps that spray asphaltic emulsion or asphalt binder within 0.02 gal/sq yd of the set rate
 - 4.3. With a hose and nozzle for application of asphaltic emulsion to areas inaccessible to the spray bar
 - 4.4. With pressure gauges and a thermometer for determining temperatures of the asphaltic emulsion or asphalt binder

You may use cab-controlled valves for the application of asphaltic emulsion or asphalt binder. The valves controlling the flow from nozzles must act positively to provide a uniform unbroken application of asphaltic emulsion or asphalt binder.

Maintain distributor and storage tanks at all times to prevent dripping.

37-1.04 PAYMENT

Not Used

37-2 CHIP SEALS

37-2.01 GENERAL

37-2.01A General

37-2.01A(1) Summary

Section 37-2.01 includes general specifications for applying chip seals.

37-2.01A(2) Definitions

Reserved

37-2.01A(3) Submittals

At least 15 days before starting placement of chip seal, submit:

1. Samples for: (provide date samples were taken on the containers)
 - 1.1. Asphaltic emulsion chip seal, six 1-quart wide mouth plastic containers with screw top lid of asphaltic emulsion
 - 1.2. Polymer modified asphaltic emulsion chip seal, six 1-quart wide mouth plastic containers with screw top lid of polymer modified asphaltic emulsion
 - 1.3. Asphalt rubber binder chip seal, two 1-quart cans of base asphalt binder
 - 1.4. Asphalt rubber binder chip seal, five 1-quart cans of asphalt rubber binder
2. Asphaltic emulsion, polymer modified asphaltic emulsion, asphalt binder or asphalt rubber binder data as follows:
 - 2.1. Supplier and Type/Grade of asphaltic emulsion or asphalt binder
 - 2.2. Type of modifier used including polymer or crumb rubber or both

- 2.3. Percent of crumb rubber, if used as modifier
- 2.4. Copy of the specified test results for asphaltic emulsion or asphalt binder
- 3. 50 lb of uncoated aggregate (provide date samples were taken on the containers)
- 4. Aggregate test results for the following:
 - 4.1. Gradation
 - 4.2. Los Angeles Rattler
 - 4.3. Percent of crushed particles
 - 4.4. Flat and elongated particles
 - 4.5. Film stripping
 - 4.6. Cleanness value
 - 4.7. Durability
- 5. Vialit test results

Submit quality control test results for the quality characteristics within the reporting times allowance after sampling shown in the following table:

Quality Control Test Result Reporting

Quality characteristic	Maximum reporting time allowance
Los Angeles Rattler loss (max, %)	48 hours
Percent of crushed particles (min, %)	48 hours
Flat and elongated particles (max by weight at 3:1, %)	48 hours
Film stripping (max, %)	48 hours
Durability (min)	48 hours
Gradation (percentage passing)	24 hours
Cleanness value (min)	24 hours
Asphaltic emulsion spread rate (gal/sq yd)	24 hours

Within 3 days after taking asphaltic emulsion or asphalt binder quality control samples, submit the authorized laboratory's test results.

37-2.01A(4) Quality Assurance

37-2.01A(4)(a) General

Reserved

37-2.01A(4)(b) Quality Control

37-2.01A(4)(b)(i) General

Reserved

37-2.01A(4)(b)(ii) Aggregate

All tests must be performed on uncoated aggregate except for film stripping which must be performed on precoated aggregate.

For aggregate, the authorized laboratory must perform sampling and testing at the specified frequency and location for the following quality characteristics:

Aggregate Quality Control Requirements

Quality characteristic	Test method	Minimum sampling and testing frequency	Location of sampling
Los Angeles Rattler loss (max, %) At 100 revolutions At 500 revolutions	California Test 211	1st day of production	See California Test 125
Percent of crushed particles Coarse aggregate (min, %) One-fractured face Two-fractured faces Fine aggregate (min, %) (Passing No. 4 sieve and retained on No. 8 sieve) One fractured face	AASHTO T 335	1st day of production	See California Test 125
Flat and elongated particles (max by weight at 3:1, %)	ASTM D4791	1st day of production	See California Test 125
Film stripping (max, %)	California Test 302	1st day of production	See California Test 125
Durability (min)	California Test 229	1st day of production	See California Test 125
Gradation (% passing)	California Test 202	2 per day	See California Test 125
Cleanness value (min)	California Test 227	2 per day	See California Test 125

37-2.01A(4)(b)(iii) Chip Seals

For a chip seal, the authorized laboratory must perform sampling and testing at the specified frequency and location for the following quality characteristics:

Chip Seal Quality Control Requirements

Quality characteristic	Test method	Minimum sampling and testing frequency	Location of sampling
Asphaltic emulsion binder spread rate (gal/sq yd)	California Test 339	1 per day per distributor truck	Pavement surface

37-2.01A(4)(c) Department Acceptance

Department Acceptance shall not apply to identified areas where the existing surfacing before application of chip seal, contains defective areas as determined by the Engineer and Contractor. At least 7 days before starting placement of the chip seal, the Contractor shall submit a written list of existing defective areas, identifying the lane direction, lane number, starting and ending highway post mile locations, and defect type. The Engineer must agree on which of the identified areas are defective.

Defective areas are defined as one of the following:

1. Areas with wheel path rutting in excess of 3/8 inch when measured by placing a straightedge 12 feet long on the finished surface perpendicular to the center line and measuring the vertical distance between the finished surface and the lower edge of the straightedge
2. Areas exhibiting flushing

For a chip seal, acceptance is based on visual inspection for the following:

1. Uniform surface texture

2. Raveling, which consists of the separation of the aggregate from the asphaltic emulsion or asphalt binder
3. Flushing, which consists of the occurrence of a film of asphaltic material on the surface of the chip seal.
4. Streaking, which consists of alternating longitudinal bands of asphaltic emulsion or asphalt binder without uniform aggregate retention, approximately parallel with the lane line.

Areas of raveling, flushing or streaking that are greater than 0.5 sq ft shall be considered defective and must be repaired.

Raveling and streaking must be repaired by placing an additional layer of chip seal over the defective area.

For asphaltic emulsion or asphalt binder, acceptance is based on the Department's sampling and testing for compliance with the requirements for the quality characteristics specified.

For aggregate, acceptance is based on the Department's sampling and testing for compliance with the requirements shown in the following table:

Chip Seal Aggregate Acceptance Criteria

Quality characteristic	Test method	Requirements
Los Angeles Rattler loss (max, %) At 100 revolutions At 500 revolutions	California Test 211	10 40
Percent of crushed particles: Coarse aggregate (min, %) One-fractured face Two-fractured faces Fine aggregate (min, %) (Passing No. 4 sieve and retained on No. 8 sieve) One fractured face	AASHTO T 335	95 90 70
Flat and elongated particles (max by weight at 3:1, %)	ASTM D4791	10
Film stripping (max, %)	California Test 302	25
Durability (min)	California Test 229	52
Gradation (% passing by weight)	California Test 202	Aggregate Gradation table shown under Materials for the chip seal type specified.
Cleanness value (min)	California Test 227	80

If test results for the aggregate gradation do not comply with specifications, you may remove the chip seal represented by these tests or request that it remain in place with a payment deduction. The deduction is \$1.75 per ton for the aggregate represented by the test results.

If test results for aggregate cleanness value do not comply with the specifications, you may remove the chip seal represented by these tests or you may request that the chip seal remain in place with a pay deduction corresponding to the cleanness value shown in the following table:

Chip Seal Cleanness Value Deductions

Cleanness value	Deduction
80 or over	None
79	\$2.00 /ton
77-78	\$4.00 /ton
75-76	\$6.00 /ton

If the aggregate cleanness value is less than 75, remove the chip seal.

37-2.01B Materials

37-2.01B(1) General

Reserved

37-2.01B(2) Asphaltic Emulsions and Asphalt Binders

Reserved

37-2.01B(3) Aggregate

37-2.01B(3)(a) General

Aggregate must be broken stone, crushed gravel, or both.

Aggregate must comply with the requirements shown in the following table:

Chip Seal Aggregate Requirements

Quality characteristic	Test method	Requirements
Los Angeles Rattler loss (max, %) At 100 revolutions At 500 revolutions	California Test 211	10 40
Percent of crushed particles Coarse aggregate (min, %) One-fractured face Two-fractured faces Fine aggregate (min, %) (Passing No. 4 sieve and retained on No. 8 sieve) One fractured face	AASHTO T 335	95 90 70
Flat and elongated particles (max by weight at 3:1, %)	ASTM D4791	10
Film stripping (max, %)	California Test 302	25
Durability (min)	California Test 229	52
Gradation (% passing by weight)	California Test 202	Aggregate Gradation table shown under Materials for the chip seal type specified.
Cleanness value (min)	California Test 227	80

The authorized laboratory must conduct the Vialit test using the proposed asphaltic emulsion or asphalt binder and aggregate for compliance with the requirements shown in the following table:

Chip Retention Requirements

Quality characteristic	Test method	Requirement
Chip retention (%)	Vialit test method for aggregate in chip seals, French chip (Modified) ^a	95

^aThe asphaltic emulsion or asphalt binder must be within the field placement temperature range and application rate during specimen preparation. For asphalt binder cure the specimen for first 2 hours at 100 °F.

37-2.01B(3)(b) Precoated Aggregate

Precoating of aggregate must be performed at a central mixing plant. The plant must be authorized under the Caltrans *MPQP*.

When precoating aggregate, do not recombine fine materials collected in dust control systems.

Precoated aggregate must be preheated from 260 to 325 degrees F. Coat with any of the asphalts specified in the table titled "Performance Graded Asphalt Binder" in section 92. The asphalt must be from 0.5 to 1.0 percent by weight of dry aggregate. You determine the exact asphalt rate for precoating of aggregate.

Do not stockpile precoated aggregate.

37-2.01C Construction

37-2.01C(1) General

For chip seals on 2-lane, 2-way roadways, place a W8-7 (LOOSE GRAVEL) sign and a W13-1 (35 mph) plaque at 2,000-foot maximum intervals along each side of the traveled way where aggregate is spread on a traffic lane and at public roads or streets entering the chip seal area. Place the 1st W8-7 sign in each direction where traffic first encounters the loose aggregate, regardless of which lane the aggregate is spread on. A W13-1 (35 mph) plaque is not required where the posted speed limit is less than 40 mph.

For chip seals on freeways, expressways, and multilane conventional highways, place a W8-7, (LOOSE GRAVEL) sign and a W13-1 (35 mph) plaque at 2,000-foot maximum intervals along the outside edge of the traveled way nearest to the lane worked on, at on ramps, and at public roads or streets entering the chip seal area. Place the 1st W8-7 sign where the aggregate starts with respect to the direction of travel on that lane. A W13-1 (35 mph) plaque is not required where the posted speed limit is less than 40 mph.

Pilot cars must have cellular or radio contact with other pilot cars and personnel in the work zone. The maximum speed of the pilot cars conveying or controlling traffic through the traffic control zone must be 15 mph on 2-lane, two-way highways and 25 mph on multilane divided and undivided highways. Pilot cars must only use traffic lanes open to traffic.

On the days that closures are not allowed, you may use a moving closure to maintain the seal coat surface. The moving closure is only allowed during daylight hours when traffic will be the least inconvenienced and delayed. The Engineer determines the hours for the moving closure.

Maintain signs in place at each location until the final sweeping of the chip seal surface for that location is complete. Signs may be set on temporary portable supports with the W13-1 sign below the W8-7 sign or on barricades with the W13-1 sign alternating with the W8-7 sign.

Schedule chip seal activities so that the chip seals are placed on both lanes of the traveled way each work shift.

If traffic is routed over a surface where a chip seal application is intended, the chip seal must not be applied to more than half the width of the traveled way at a time, and the remaining width must be kept free of obstructions and open to traffic until the previously applied width is ready for traffic use.

Wherever maintenance sweeping of the chip seal surface is complete, place permanent traffic stripes and pavement markings within 10 days.

If you fail to place the permanent traffic stripes and pavement markings within the specified time, the Department withholds 50 percent of the estimated value of the chip seal work completed that has not received permanent traffic stripes and pavement markings.

37-2.01C(2) Equipment

Equipment for chip seals must include and comply with the following:

1. Aggregate haul trucks must have:
 - 1.1. Tailgate that discharges aggregate
 - 1.2. Device to lock onto the rear aggregate spreader hitch
 - 1.3. Dump bed that will not push down on the spreader when fully raised
 - 1.4. Dump bed that will not spill aggregate on the roadway when transferred to the spreader hopper
 - 1.5. Tarpaulin to cover precoated aggregate when haul distance exceeds 30 minutes or ambient temperature is less than 65 degrees F
2. Self-propelled aggregate spreaders must have:

- 2.1. Aggregate hopper in the rear
- 2.2. Belt conveyor that carries the aggregate to the front
- 2.3. Spreading hopper capable of providing a uniform aggregate spread rate over the entire width of the traffic lane in 1 application.
3. Self-propelled power brooms must:
 - 3.1. Not be steel-tined brooms on emulsion chip seals
 - 3.2. Be capable of removing loose aggregate adjacent to barriers that prevent aggregate from being swept off the roadway, including curbs, gutters, dikes, berms, and railings
4. Pneumatic or foam filled rubber tired rollers must:
 - 4.1. Be an oscillating type at least 4 feet wide
 - 4.2. Be self-propelled and reversible
 - 4.3. Have tires of equal size, diameter, type, and ply
 - 4.4. Carry at least 3,000 lbs of load on each wheel
 - 4.5. Have tires with an air pressure of 100 ± 5 psi or be foam filled

37-2.01C(3) Surface Preparation

Before applying chip seals, cover manholes, valve and monument covers, grates, or other exposed facilities located within the area of application, using a plastic or oil resistant construction paper secured by tape or adhesive to the facility being covered. Reference the covered facilities with enough control points to relocate the facilities after the application of the chip seal.

Immediately before applying chip seals, clean the surface to receive a chip seal by removing any extraneous material affecting adhesion of the chip seal with the existing surface and drying. Use self-propelled power brooms to clean the existing pavement.

37-2.01C(4) Placement

37-2.01C(4)(a) General

Schedule the operations so that chip seals are placed on both lanes of the traveled way each work shift. At the end of the work shift, the end of the chip seals on both lanes must generally match.

37-2.01C(4)(b) Applying Asphaltic Emulsions or Asphalt Binders

Prevent spraying on existing pavement not intended for chip seals or on previously applied chip seals using a material such as building paper. Remove the material after use.

Align longitudinal joints between chip seal applications with designated traffic lanes.

For asphaltic emulsion or asphalt binder, overlap longitudinal joints by not more than 4 inches. You may overlap longitudinal joints up to 8 inches if authorized.

For areas not accessible to a truck distributor bar apply:

1. Asphaltic emulsions by hand spraying
2. Asphalt binders with a squeegee or other authorized means

You may overlap the asphaltic emulsion or asphalt binder applications before the application of aggregate at longitudinal joints.

Do not apply the asphaltic emulsion or asphalt binder unless there is sufficient aggregate at the job site to cover the asphaltic emulsion or asphalt binder.

Discontinue application of asphaltic emulsion or asphalt binder early enough to comply with lane closure requirements. Apply to 1 lane at a time and cover the lane width entirely in 1 operation.

37-2.01C(4)(c) Spreading Aggregates

37-2.01C(4)(c)(i) General

Prevent vehicles from driving on asphaltic emulsion or asphalt binder before spreading aggregate.

Spread aggregate within 10 percent of your determined rate.

Spread aggregate at a uniform rate over the full lane width in 1 application. Apply to 1 lane at a time.

Sweep excess aggregate at joints before spreading adjacent aggregate.

Operate the spreader at speeds slow enough to prevent aggregate from rolling over after dropping.

If the spreader is not moving, aggregate must not drop. If you stop spreading and aggregate drops, remove the excess aggregate before resuming activities.

37-2.01C(4)(d) Finishing

37-2.01C(4)(d)(i) General

Remove piles, ridges, or unevenly distributed aggregate. Repair permanent ridges, bumps, streaks or depressions in the finished surface. Spread additional aggregate and roll if aggregate is picked up by rollers or vehicles.

Chip seal joints between adjacent applications of a chip seal must be smooth, straight, uniform, and completely covered.

A coverage is 1 roller movement over the entire width of lane. A pass is 1 roller movement parallel to the chip seal application in either direction. Overlapping passes are part of the coverage being made and are not part of a subsequent coverage. Do not start a new coverage until completing the previous coverage.

Finish the chip seals in the following sequence:

- 1. Perform initial rolling consisting of 1 coverage with a pneumatic-tired roller**
- 2. Perform final rolling consisting of 2 coverages with a pneumatic-tired roller**
- 3. Sweep excess aggregate from the roadway and adjacent abutting areas**
- 4. Apply a flush coat**
- 5. Remove covers from the facilities**

37-2.01C(4)(d)(ii) Traffic Control With Pilot Car

For 2-lane 2-way roadways under 1-way traffic control, upon completion of final rolling, traffic must be controlled with pilot cars and routed over the new chip seal for a period of 2 to 4 hours before opening the lane to traffic not controlled with pilot cars.

For multilane roadways, when traffic is controlled with pilot cars, a maximum of 1 lane in the direction of travel must be open to traffic. Traffic must be controlled with pilot cars and be routed on the new chip seal surface of the lane for a minimum of 2 hours after completion of the initial sweeping and before opening the lane to traffic not controlled with pilot cars. Once traffic controlled with pilot cars is routed over the chip seal at a particular location, continuous control must be maintained at that location until the chip seal placement and sweeping on adjacent lanes to receive a chip seal is completed.

37-2.01C(4)(d)(iii) Sweeping

Sweeping must be performed after the chip seal has set and there is no damage or dislodging of aggregate from the chip seal surface. In addition to previous sweeping, perform final sweeping immediately before opening any lane to public traffic, not controlled with pilot cars.

37-2.01C(4)(d)(iv) Excess Aggregate

Dispose of excess aggregate. If ordered, salvaging and stockpiling of excess aggregate is change order work.

37-2.01C(4)(e) Chip Seal Maintenance

Perform sweeping on the morning following the application of aggregate on any lane that has been open to traffic not controlled with pilot cars and before starting any other activities.

Chip seal surfaces must be maintained for 4 consecutive days, up to 7 consecutive days at Engineer's discretion particularly in twisting and winding road areas, from the day aggregate is applied. Maintenance must include sweeping to maintain a surface free of loose aggregate and to prevent formation of

corrugations. Sweeping must not dislodge aggregate set in asphaltic emulsion or asphalt binder. Perform sweeping at adjacent intersection to maintain a surface free of loose aggregate.

After 4 consecutive days, up to 7 consecutive days as discussed above, excess aggregate must be removed from the paved areas.

37-2.01D Payment

If there is no bid item for traffic control system, furnishing and using a pilot car is included in the various items of the work involved in applying the chip seal.

If recorded batch weights are printed automatically, the payment quantity for aggregate is the weight determined from the printed batch weights if:

1. Total asphalt binder weight per batch is printed
2. Zero tolerance weight is printed before weighing the first batch and after weighing the last batch for each truckload
3. Time, date, mix number, load number, and truck identification are correlated with a load slip
4. Copy of the recorded batch weights is certified by a licensed weighmaster

37-2.03 POLYMER MODIFIED ASPHALTIC EMULSION CHIP SEALS

37-2.03A General

37-2.03A(1) Summary

Section 37-2.03 includes specifications for applying polymer modified asphaltic emulsion chip seals. A polymer modified asphaltic emulsion chip seal includes applying a polymer modified asphaltic emulsion, followed by aggregate, and then a flush coat.

A double polymer modified asphaltic emulsion chip seal is the application of a polymer modified asphaltic emulsion followed by aggregate, applied twice in sequence and then a flush coat.

37-2.03A(2) Definitions

Reserved

37-2.03A(3) Submittals

Immediately after sampling, submit two 1-quart cans of polymer modified asphaltic emulsion taken in the presence of the Engineer. A sample must be submitted in an insulated shipping container.

37-2.03A(4) Quality Assurance

37-2.03A(4)(a) General

Reserved

37-2.03A(4)(b) Quality Control

37-2.03A(4)(b)(i) General

Reserved

37-2.03A(4)(b)(ii) Polymer Modified Asphaltic Emulsions

Circulate polymer modified asphaltic emulsions in the distributor truck before sampling. Take samples from the distributor truck at mid load or from a sampling tap or thief. Before taking samples, draw and dispose of 1 gallon. In the presence of the Engineer, take two 1-quart samples for acceptance testing.

For polymer modified asphaltic emulsions, the authorized laboratory must perform quality control sampling and testing at the specified frequency and location for the following quality characteristics:

Polymer Modified Asphaltic Emulsion

Quality characteristic	Test method	Minimum sampling and testing frequency	Sampling location
Saybolt Furol Viscosity, at 50 °C (Saybolt Furol seconds)	AASHTO T 59	Minimum 1 per day per delivery truck	Distributor truck
Settlement, 5 days (max, %)			
Storage stability test, 1 day (max, %)			
Sieve test (max, %)			
Demulsibility (min, %)			
Particle charge			
Ash content (max, %)			
Residue by evaporation (min, %)	California Test 331		
Tests on residue from evaporation test:			
Penetration, 25 °C	AASHTO T 49	Minimum 1 per day per delivery truck	Distributor truck
Penetration, 4 °C, 200g for 60 seconds	AASHTO T 49		
Ductility, 25 °C (min, mm)	AASHTO T 51		
Torsional recovery (min, %)	California Test 332		
Ring and Ball Softening Point (min, °F)	AASHTO T 53		

37-2.03A(4)(c) Department Acceptance

Aggregate acceptance is based on the Department's sampling and testing for compliance with the requirements shown in the following table:

Aggregate Gradation Acceptance Criteria

Quality characteristic	Test method	Requirement		
		3/8"	5/16"	1/4"
Gradation (% passing by weight)	California Test 202	3/8"	5/16"	1/4"
Sieve size:				
3/4"		--	--	--
1/2"		100	--	--
3/8"		85–100	100	100
No. 4		0–15	0–50	60–85
No. 8		0–5	0–15	0–25
No. 16		--	0–5	0–5
No. 30		--	0–3	0–3
No. 200		0–2	0–2	0–2

37-2.03B Materials

37-2.03B(1) General

Reserved

37-2.03B(2) Polymer Modified Asphaltic Emulsions

A polymer modified asphaltic emulsion must include elastomeric polymer.

A polymer modified asphaltic emulsion must be Grade PMRS2, PMRS2h, PMCRS2, or PMCRS2h. Polymer content in percent by weight does not apply.

A polymer modified asphaltic emulsion must comply with section 94 and the quality characteristic requirements in the following table:

Polymeric Asphaltic Emulsion

Quality characteristic	Test method	Requirement
Penetration, 4 °C, 200g for 60 seconds (min)	AASHTO T 49	6
Ring and Ball Softening Point (min, °F)	AASHTO T 53	135

37-2.03B(3) Aggregate

The aggregate gradation for a polymer modified asphaltic emulsion chip seal must comply with the requirements shown in the following table:

Asphaltic Emulsion Chip Seal Aggregate Gradation

Quality characteristic	Test method	Requirement		
Gradation (% passing by weight) Sieve Size	California Test 202	3/8"	5/16"	1/4"
3/4"		--	--	--
1/2"		100	--	--
3/8"		85–100	100	100
No. 4		0–15	0–50	60–85
No. 8		0–5	0–15	0–25
No. 16		--	0–5	0–5
No. 30		--	0–3	0–3
No. 200		0–2	0–2	0–2

37-2.03C Construction

Polymer modified asphaltic emulsions must be applied within the application rate ranges shown in the following table:

Polymer Modified Asphaltic Emulsion Application Rates

Aggregate gradation	Application rate range (gal/sq yd)
3/8"	0.30–0.45
5/16"	0.25–0.35
1/4"	0.20–0.30

For double polymer modified asphaltic emulsion chip seals, polymer modified asphaltic emulsions must be applied within the application rates shown in the following table:

Polymer Modified Asphaltic Emulsion Application Rates

Double application	Application rate range (gal/sq yd)
1st application	0.30–0.45
2nd application	0.20–0.30

Apply polymer modified asphaltic emulsions when the ambient air temperature is from 60 to 105 degrees F and the pavement surface temperature is at least 80 degrees F.

Do not apply polymer modified asphaltic emulsions when weather forecasts predict the ambient air temperature will fall below 39 degrees F within 24 hours after application.

Aggregate must be spread within the spread rate ranges shown in the following table:

Chip seal type	Spread rate range (lb/sq yd)
3/8"	20–30
5/16"	16–25
1/4"	12–20

For double chip seals, aggregate must be spread within spread rate ranges shown in the following table:

Double application	Spread rate range (lb/sq yd)
1st application	23–30
2nd application	12–20

Remove excess aggregate on the 1st application before the 2nd application of asphaltic emulsion.

You may stockpile aggregate for the polymer modified asphaltic emulsion chip seals if you prevent contamination. Aggregate must have damp surfaces at spreading. If water visibly separates from the aggregate, do not spread. You may redampen aggregate in the delivery vehicle.

Spread aggregate before the polymer modified asphaltic emulsion sets or breaks.

Do not spread aggregate more than 2,500 feet ahead of the completed initial rolling.

37-2.03D Payment

Not Used

37-4 FOG SEALS AND FLUSH COATS

37-4.01 GENERAL

37-4.01A General

37-4.01A(1) Summary

Section 37-4.01 includes general specifications for applying fog seals and flush coats.

37-4.01A(2) Definitions

Reserved

37-4.01A(3) Submittals

At least 15 days before use, submit:

1. Sample of asphaltic emulsion in two 1-quart plastic container with lined, sealed lid
2. Asphaltic emulsion information and test data as follows:
 - 2.1. Supplier
 - 2.2. Type/Grade of asphalt emulsion
 - 2.3. Copy of the specified test results for asphaltic emulsion

37-4.01B Materials

Not Used

37-4.01C Construction

37-4.01C(1) General

Reserved

37-4.01C(2) Weather Conditions

Only place a fog seal or flush coat if both the pavement and ambient temperatures are at least 50 degrees F and rising. Do not place a fog seal or flush coat within 24 hours of rain or within 24 hours of forecast rain or freezing temperatures.

37-4.01D Payment

Not Used

37-4.02 FOG SEALS

37-4.02A General

37-4.02A(1) Summary

Section 37-4.02 includes specifications for applying fog seals.

Applying a fog seal includes applying a diluted slow-setting or quick setting asphaltic emulsion.

37-4.02A(2) Definitions

Reserved

37-4.02A(3) Submittals

Immediately after sampling, submit two 1-quart plastic container of asphaltic emulsion taken in the presence of the Engineer. Samples must be submitted in insulated shipping container.

37-4.02A(4) Quality Assurance

37-4.02A(4)(a) General

Reserved

37-4.02A(4)(b) Quality Control

37-4.02A(4)(b)(i) General

Reserved

37-4.02A(4)(b)(ii) Asphaltic Emulsions

Circulate asphaltic emulsions in the distributor truck before sampling. Take samples from the distributor truck at mid load or from a sampling tap or thief. Before taking samples, draw and dispose of 1 gallon. In the presence of the Engineer, take asphalt emulsion sample in two 1-quart plastic container with lined, sealed lid.

For asphaltic emulsions, the authorized laboratory must perform quality control sampling and testing at the specified frequency and location for the following quality characteristics:

Asphaltic Emulsion

Quality characteristic	Test Method	Minimum sampling and testing frequency	Sampling location
Saybolt Furol Viscosity, at 25 °C (Saybolt Furl seconds)	AASHTO T 59	Minimum 1 per day per delivery truck	Distributor truck
Sieve Test (%)			
Storage stability, 1 day (%)			
Residue by distillation (%)			
Particle charge ^a			
Tests on Residue from Distillation Test:			
Penetration, 25 °C	AASHTO T 49	Minimum 1 per day per delivery truck	Distributor truck
Ductility	AASHTO T 51		
Solubility in trichloroethylene	AASHTO T 44		

^aIf the result of the particle charge is inconclusive, the asphaltic emulsion must be tested for pH under ASTM E70. Grade QS1h asphaltic emulsion must have a minimum pH of 7.3. Grade CQS1h asphaltic emulsion must have a maximum pH of 6.7.

37-4.02A(4)(b)(iii) Asphaltic Emulsion Spread Rates

For fog seals, the authorized laboratory must perform sampling and testing at the specified frequency and location for the following quality characteristics:

Fog Seal Quality Control Requirements

Quality characteristic	Test method	Minimum sampling and testing frequency	Location of sampling
Asphaltic emulsion spread rate (gal/sq yd)	California Test 339	2 per day	Pavement surface

37-4.02A(4)(c) Department Acceptance

Fog seal acceptance is based on:

1. Visual inspection for the following:
 - 1.1. Uniform surface texture throughout the work limits
 - 1.2. Flushing consisting of the occurrence of a film of asphaltic material on the surface
 - 1.4. Streaking consisting of alternating longitudinal bands of asphaltic emulsion approximately parallel with the lane line
2. The Department's sampling and testing for compliance with the requirements for the quality characteristics specified in section 94 for asphaltic emulsion
3. Department's sampling and testing for compliance with the requirements for fog seal shown in the following table:

Fog Seal Acceptance Criteria

Quality Characteristic	Test Method	Requirement
Asphaltic emulsion spread rate (gal/sq yd)	California Test 339	TV ± 10%

37-4.02B Materials

You determine the grade of slow-setting or quick setting asphaltic emulsion to be used.

37-4.02C Construction

Apply asphaltic emulsions for fog seals at a residual asphalt rate from 0.02 to 0.06 gal/sq yd.

If additional water is added to the asphaltic emulsions, the resultant mixture must not be more than 1 part asphaltic emulsion to 1 part water. You determine the dilution rate.

If the fog seals become tacky, sprinkle water as required.

If fog seals and chip seals are on the same project, the joint between the seal coats must be neat and uniform.

37-4.02D Payment

The Department does not adjust the unit price for an increase or decrease in the asphaltic emulsion quantity.

37-4.03 FLUSH COATS

37-4.03A General

37-4.03A(1) Summary

Section 37-4.03 includes specifications for applying flush coats.

Use either CQS-1H or CSS-1H asphaltic emulsion for flush coat.

Applying a flush coat includes applying a fog seal coat followed by sand.

37-4.03A(2) Definitions

Reserved

37-4.03A(3) Submittals

At least 15 days before use, submit:

1. Proposed target X values for sand gradation.
2. Gradation test results for sand

Submit quality control test results for sand gradation within 2 business days of sampling.

37-4.03A(4) Quality Assurance

37-4.03A(4)(a) General

Reserved

37-4.03A(4)(b) Quality Control

For sand, the authorized laboratory must perform sampling and testing at the specified frequency and location for the following quality characteristics:

Sand Quality Control

Quality characteristic	Test method	Minimum sampling and testing frequency	Location of sampling
Gradation (% passing by weight)	California Test 202	1 per day	See California Test 125

37-4.03A(4)(c) Department Acceptance

Flush coat acceptance is based on fog seal acceptance and the following:

1. Visual inspection for uniform application of sand.
2. Sand acceptance is based on the Department's sampling and testing for compliance with the requirements shown in the following table:

Sand Gradation Acceptance Criteria

Quality characteristic	Test method	Requirement
Gradation (% passing by weight)	California Test 202	
Sieve size:		
3/8"		100
No. 4		93-100
No. 8		61-99
No. 16		X ± 13
No. 30		X ± 12
No. 50		X ± 9
No.100		1-15
No. 200	0-10	

NOTE: "X" is the gradation that you propose to furnish for the specific sieve size.

37-4.03B Material

37-4.03B(1) General

Reserved

37-4.03B(2) Sand

Sand must be free from deleterious coatings, clay balls, roots, bark, sticks, rags, and other extraneous material.

Sand for a flush coat must comply with the gradations shown in the following table:

Sand Gradation

Quality characteristic	Test method	Requirement
Gradation (% passing by weight)	California Test 202	
Sieve size:		
3/8"		100
No. 4		93-100
No. 8		61-99
No. 16		X ± 13
No. 30		X ± 12
No. 50		X ± 9
No.100		1-15
No. 200	0-10	

NOTE: "X" is the gradation that you propose to furnish for the specific sieve size.

Fine aggregate sizes must be distributed such that the difference between the total percentage passing the No. 16 and No. 30 sieves is from 10 to 40, and the difference between the percentage passing the No. 30 and No. 50 sieves is from 10 to 40.

37-4.03C Construction

37-4.03C(1) General

Do not track asphaltic emulsion on existing pavement surfaces.

Allow oil from fog seal coat to "break", or as directed by the Engineer, before spreading sand aggregate. The sand moisture content is not more than the sand SSD (Saturated Surface Dry) plus one percent.

No tires are allowed on asphaltic emulsions (fog seal coat) before sand aggregate has been placed.

Spread sand aggregate with the chipping machine (self-propelled aggregate spreaders) as described in Section 37-2.01C(2) that spreads sand at a uniform rate over the full width of a traffic lane in a single

application. Spread sand at a rate from 2 to 6 lb/sq yd. You determine the application rates for sand and the Engineer authorizes the application rate.

37-4.03C(2) Sweeping

Sweep loose sand material remaining on the surface 24 hours after application.

37-4.03D Payment

The Department does not adjust the unit price for an increase or decrease in the sand cover (seal) quantity.

37-7-37-10 RESERVED

Replace Section 39 with:

39 ASPHALT CONCRETE

39-1 GENERAL

39-1.01 GENERAL

Section 39 includes specifications for performing asphalt concrete work.

39-1.02 MATERIALS

Not Used

39-1.03 CONSTRUCTION

Not Used

39-1.04 PAYMENT

Not Used

39-2 HOT MIX ASPHALT

39-2.01 GENERAL

39-2.01A General

39-2.01A(1) Summary

Section 39-2.01 includes general specifications for producing and placing hot mix asphalt.

HMA includes one or more of the following types:

1. Type A HMA
2. RHMA-G
3. OGFC
4. BWC
5. Minor HMA

WMA technologies must be on the Authorized Material List for WMA authorized technologies.

For HMA that uses asphalt binder containing crumb rubber modifier, submit a Crumb Rubber Usage Report form monthly and at the end of the project.

Wherever reference is made to the following test methods, the year of publication for these test methods is as shown in the following table:

Test method	Year of publication
AASHTO M 17	2011 (2015)
AASHTO M 323	2013
AASHTO R 30	2002 (2015)
AASHTO R 35	2014
AASHTO T 27	2014
AASHTO T 49	2014
AASHTO T 59	2013
AASHTO T 96	2002 (2010)
AASHTO T 164	2014
AASHTO T 176	2008
AASHTO T 209	2012
AASHTO T 269	2014
AASHTO T 275	2007 (2012)
AASHTO T 283	2014
AASHTO T 304	2011
AASHTO T 305	2014
AASHTO T 308	2010
AASHTO T 312	2014
AASHTO T 324	2014
AASHTO T 329	2013
AASHTO T 335	2009
ASTM D36/D36M	2014 ^{ε1}
ASTM D92	2012b
ASTM D217	2010
ASTM D297	2013
ASTM D445	2014
ASTM D2007	2011
ASTM D2074	2007 (Reapproved 2013)
ASTM D2995	1999 (Reapproved 2009)
ASTM D4791	2010
ASTM D5329	2009
ASTM D7741/D7741M	2011 ^{ε1}
Asphalt Institute MS-2	7th edition (2015)

39-2.01A(2) Definitions

binder replacement: Binder from RAP expressed as a percent of the total binder in the mix.

coarse aggregate: Aggregate retained on a no. 4 sieve.

fine aggregate: Aggregate passing a no. 4 sieve.

leveling course: Thin layer of HMA used to correct minor variations in the longitudinal and transverse profile of the pavement before placement of other pavement layers.

miscellaneous areas: Areas outside the traveled way and shoulders such as:

1. Median areas not including inside shoulders
2. Island areas
3. Sidewalks
4. Gutters
5. Ditches
6. Overside drains
7. Aprons at ends of drainage structures

8. Driveways and driveway approaches

processed RAP: RAP that has been fractionated.

supplemental fine aggregate: Mineral filler consisting of rock dust, slag dust, hydrated lime, hydraulic cement, or any combination of these and complying with AASHTO M 17.

39-2.01A(3) Submittals

39-2.01A(3)(a) General

Reserved

39-2.01A(3)(b) Job Mix Formula

39-2.01A(3)(b)(i) General

Except for the HMA to be used in miscellaneous areas, dikes, and berms, submit your proposed JMF for each type of HMA to be used. The JMF must be submitted on the Contractor Job Mix Formula Proposal form along with:

1. Mix design documentation on Contractor Hot Mix Asphalt Design Data form dated within 12 months of submittal
2. JMF verification on a Caltrans Hot Mix Asphalt Verification form, if applicable
3. JMF renewal on a Caltrans Job Mix Formula Renewal form, if applicable
4. SDS for:
 - 4.1. Asphalt binder
 - 4.2. Supplemental fine aggregate except fines from dust collectors
 - 4.3. Antistrip additives

The Contractor Hot Mix Asphalt Design Data form must show documentation on aggregate quality.

If you cannot submit a Department-verified JMF on a Caltrans Hot Mix Asphalt Verification form dated within 12 months before HMA production, the Engineer verifies the JMF.

Submit a new JMF if you change any of the following:

1. Target asphalt binder percentage greater than ± 0.2 percent
2. Asphalt binder supplier
3. Combined aggregate gradation
4. Aggregate sources
5. Liquid antistrip producer or dosage
6. Average binder content in a new processed RAP stockpile by more than ± 2.00 percent from the average RAP binder content reported on page 4 of your Contractor Hot Mix Asphalt Design Data form
7. Average maximum specific gravity in a new processed RAP stockpile by more than ± 0.060 from the average maximum specific gravity value reported on page 4 of your Contractor Hot Mix Asphalt Design Data form
8. Any material in the JMF, except lime supplier and source

Allow the Engineer 5 business days from a complete JMF submittal for document review of the aggregate qualities, mix design, and JMF. The Engineer notifies you if the proposed JMF submittal is accepted.

If your JMF fails verification testing, submit an adjusted JMF based on your testing. The adjusted JMF must include a new Contractor Job Mix Formula Proposal form, Contractor Hot Mix Asphalt Design Data form, and the results of the failed verification testing.

You may submit an adjusted aggregate gradation TV on a Contractor Job Mix Formula Proposal form before verification testing. Aggregate gradation TV must be within the TV limits specified.

39-2.01A(3)(b)(ii) Job Mix Formula Renewal

You may request a JMF renewal by submitting:

1. Proposed JMF on a Contractor Job Mix Formula Proposal form
2. Previously verified JMF documented on a Caltrans Hot Mix Asphalt Verification form dated within 12 months
3. Mix design documentation on a Contractor Hot Mix Asphalt Design Data form used for the previously verified JMF

39-2.01A(3)(b)(iii) Job Mix Formula Modification

For an authorized JMF, submit a modified JMF if you change any of the following:

1. Asphalt binder supplier
2. Liquid antistriper producer
3. Liquid antistriper dosage

You may change any of the above items only once during the Contract.

Submit your modified JMF request at least 15 days before production. Each modified JMF submittal must include:

1. Proposed modified JMF on Contractor Job Mix Formula Proposal form, marked *Modified*.
2. Mix design records on Contractor Hot Mix Asphalt Design Data form for the authorized JMF to be modified.
3. JMF verification on Hot Mix Asphalt Verification form for the authorized JMF to be modified.
4. Test results for the modified JMF in compliance with the mix design specifications. Perform tests at the mix design OBC as shown on the Contractor Asphalt Mix Design Data form.

With an accepted modified JMF submittal, the Engineer verifies each modified JMF within 10 days of receiving all verification samples.

39-2.01A(3)(c) Quality Control Plan

With your proposed JMF submittal, submit a QC plan for HMA.

The QC plan must describe the organization and procedures for:

1. Controlling HMA quality characteristics
2. Taking samples, including sampling locations
3. Establishing, implementing, and maintaining QC
4. Determining when corrective actions are needed
5. Implementing corrective actions
6. Using methods and materials for backfilling core locations

The QC plan must address the elements affecting HMA quality, including:

1. Aggregates
2. Asphalt binder
3. Additives
4. Production
5. Paving

The QC plan must include aggregate QC sampling and testing during lime treatment.

The QC Plan must include action and suspension limits and details of corrective action to be taken if any process is outside of those limits. Suspension limits must not exceed specified acceptance criteria.

The QC plan must describe how test results will be submitted including times for sampling and testing for each quality characteristic.

Allow 5 business days for review of the QC plan.

If you change QC procedures, personnel, or sample testing locations, submit a QC plan supplement before implementing the proposed change. Allow 3 business days for review of the QC plan supplement.

39-2.01A(3)(d) Test Results

For mix design, JMF verification, production start-up, and each 10,000 tons, submit AASHTO T 283 and AASHTO T 324 (Modified) test results to the Engineer.

Submit all QC test results, except AASHTO T 283 and AASHTO T 324 (Modified), within 3 business days of a request. Submit AASHTO T 283 QC tests within 15 days of sampling.

For tests performed under AASHTO T 324 (Modified), submit test data and 1 tested sample set within 5 business days of sampling.

If coarse and fine durability index tests are required, submit test results within 2 business days of sampling.

If a tapered notched wedge is used, submit compaction test result values within 24 hours of testing.

39-2.01A(3)(e) Reserved

39-2.01A(3)(f) Liquid Antistrip Treatment

If liquid antistrip treatment is used, submit the following with your proposed JMF submittal:

1. One 1 pt sample
2. Infrared analysis, including copy of absorption spectra
3. Certified copy of test results
4. Certificate of compliance for each liquid antistrip shipment. On each certificate of compliance, include:
 - 4.1. Your signature and printed name
 - 4.2. Shipment number
 - 4.3. Material type
 - 4.4. Material specific gravity
 - 4.5. Refinery
 - 4.6. Consignee
 - 4.7. Destination
 - 4.8. Quantity
 - 4.9. Contact or purchase order number
 - 4.10. Shipment date
5. Proposed proportions for the liquid antistrip

For each delivery of liquid antistrip to the HMA production plant, submit a 1 pt sample to the Engineer. Submit shipping documents. Label each liquid antistrip sampling container with:

1. Liquid antistrip type
2. Application rate
3. Sample date
4. Contract number

At the end of each day's production shift, submit production data in electronic media. Present data on electronic media in a tab delimited format. Use line feed carriage return with 1 separate record per line for each production data set. Allow enough fields for the specified data. Include data titles at least once per report. For each HMA mixing plant type, submit the following information in the order specified:

1. For batch plant mixing:
 - 1.1. Production date
 - 1.2. Time of batch completion
 - 1.3. Mix size and type
 - 1.4. Each ingredient's weight
 - 1.5. Asphalt binder content as a percentage of the total weight of mix

- 1.6. Liquid antistripping content as a percentage of the asphalt binder weight
2. For continuous mixing plant:
 - 2.1. Production date
 - 2.2. Data capture time
 - 2.3. Mix size and type
 - 2.4. Flow rate of wet aggregate collected directly from the aggregate weigh belt
 - 2.5. Aggregate moisture content as a percentage of the dry aggregate weight
 - 2.6. Flow rate of asphalt binder collected from the asphalt binder meter
 - 2.7. Flow rate of liquid antistripping collected from the liquid antistripping meter
 - 2.8. Asphalt binder content as a percentage of the total weight of mix calculated from:
 - 2.8.1. Aggregate weigh belt output
 - 2.8.2. Aggregate moisture input
 - 2.8.3. Asphalt binder meter output
 - 2.9. Liquid antistripping content as a percentage of the asphalt binder weight calculated from:
 - 2.9.1. Asphalt binder meter output
 - 2.9.2. Liquid antistripping meter output

39-2.01A(3)(g) Lime Treatment

If aggregate lime treatment is used, submit the following with your proposed JMF submittal and each time you produce lime-treated aggregate:

1. Exact lime proportions for fine and coarse virgin aggregates
2. If marination is required, the averaged aggregate quality test results within 24 hours of sampling
3. For dry lime aggregate treatment, a treatment data log from the dry lime and aggregate proportioning device in the following order:
 - 3.1. Treatment date
 - 3.2. Time of day the data is captured
 - 3.3. Aggregate size being treated
 - 3.4. HMA type and mix aggregate size
 - 3.5. Wet aggregate flow rate collected directly from the aggregate weigh belt
 - 3.6. Aggregate moisture content, expressed as a percentage of the dry aggregate weight
 - 3.7. Flow rate of dry aggregate calculated from the flow rate of wet aggregate
 - 3.8. Dry lime flow rate
 - 3.9. Lime ratio from the authorized JMF for each aggregate size being treated
 - 3.10. Lime ratio from the authorized JMF for the combined aggregates
 - 3.11. Actual lime ratio calculated from the aggregate weigh belt output, aggregate moisture input, and dry lime meter output, expressed as a percentage of the dry aggregate weight
 - 3.12. Calculated difference between the authorized lime ratio and the actual lime ratio
4. For lime slurry aggregate treatment, a treatment data log from the slurry proportioning device in the following order:
 - 4.1. Treatment date
 - 4.2. Time of day the data is captured
 - 4.3. Aggregate size being treated
 - 4.4. Wet aggregate flow rate collected directly from the aggregate weigh belt
 - 4.5. Moisture content of the aggregate just before treatment, expressed as a percentage of the dry aggregate weight
 - 4.6. Dry aggregate flow rate calculated from the wet aggregate flow rate
 - 4.7. Lime slurry flow rate measured by the slurry meter
 - 4.8. Dry lime flow rate calculated from the slurry meter output
 - 4.9. Authorized lime ratio for each aggregate size being treated
 - 4.10. Actual lime ratio calculated from the aggregate weigh belt and slurry meter output, expressed as a percentage of the dry aggregate weight
 - 4.11. Calculated difference between the authorized lime ratio and actual lime ratio
 - 4.12. Dry lime and water proportions at the slurry treatment time

Each day during lime treatment, submit the treatment data log on electronic media in tab delimited format. Each continuous treatment data set must be a separate record using a line feed carriage return to present the specified data on 1 line. The reported data must include data titles at least once per report.

39-2.01A(3)(h) Warm Mix Asphalt Technology

If a WMA technology is used, submit the following with your proposed JMF submittal:

1. SDS for the WMA technology
2. For water injection foam technology:
 - 2.1. Name of technology
 - 2.2. Proposed foaming water content
 - 2.3. Proposed HMA production temperature range
 - 2.4. Certification from binder supplier stating no antifoaming agent is used
3. For additive technology:
 - 3.1. Name of technology
 - 3.2. Percent admixture by weight of binder and percent admixture by total weight of HMA as recommended by the manufacturer
 - 3.3. Methodology for inclusion of admixture in laboratory-produced HMA
 - 3.4. Proposed HMA production temperature range

Collect and hold data for the duration of the Contract and submit the electronic media daily. The snapshot of production data must include the following:

1. Production date
2. Production location
3. Time of day the data is captured
4. HMA mix type being produced and target binder rate
5. HMA additive type, brand, and target rate
6. Temperature of the binder and HMA mixture
7. For a continuous mixing plant, the rate of flow of the dry aggregate calculated from the wet aggregate flow rate as determined by the conveyor scale
8. For a continuous mixing plant, the rate of flow of the asphalt meter
9. For a continuous mixing plant, the rate of flow of HMA additive meter
10. For batch plant mixing, actual batch weights of all ingredients
11. Dry aggregate to binder ratio calculated from metered ingredient output
12. Dry aggregate to HMA additive ratio calculated from metered output

At the end of each day's production shift, submit electronic media from the HMA plant process controller. Present data on electronic media in comma-separated values or tab-separated values format. The captured data for the ingredients represented by the production snapshot must have allowances for sufficient fields to satisfy the amount of data required by these specifications and include data titles at least once per report.

39-2.01A(3)(i) Reserved

39-2.01A(3)(m)–39-2.01A(3)(o) Reserved

39-2.01A(4) Quality Assurance

39-2.01A(4)(a) General

AASHTO T 324 (Modified) is AASHTO T 324 with the following parameters:

1. Target air voids must equal 7.0 ± 1.0 percent
2. Specimen height must be 60 ± 1 mm
3. Number of test specimens must be 4 to run 2 tests
4. Do not average the 2 test results
5. Test specimen must be a 150 mm gyratory compacted specimen
6. Test temperature must be set at:

- 6.1. 113 ± 2 degrees F for PG 58
- 6.2. 122 ± 2 degrees F for PG 64
- 6.3. 131 ± 2 degrees F for PG 70 and above
7. Measurements for impression must be taken at every 100 passes along the total length of the sample
8. Inflection point is the number of wheel passes at the intersection of the creep slope and the stripping slope at maximum rut depth
9. Testing shut off must be set at 25,000 passes
10. Submersion time for samples must not exceed 4 hours

Take samples under California Test 125.

If a WMA technology is used, a technical representative for the WMA technology must attend the preconstruction meeting.

39-2.01A(4)(b) Job Mix Formula Verification

The Engineer verifies the JMF from samples taken from HMA produced by the plant to be used. The production set point at the plant must be within ±0.2 from the asphalt binder percentage TV shown in your Contractor Job Mix Formula Proposal form. Notify the Engineer at least 2 business days before sampling materials. Samples may be taken from a different project including a non-Department project if you make arrangements for the Engineer to be present during sampling.

In the Engineer's presence and from the same production run, take samples of:

1. Aggregates. Coarse, fine, and supplemental fine aggregates must be taken from the combined cold-feed belt or the hot bins. If lime treatment is required, samples must be taken from individual stockpiles before lime treatment. Samples must be at least 120 lb for each coarse aggregate, 80 lb for each fine aggregate, and 10 lb for each type of supplemental fine aggregate. For hot-bin samples, the Department combines these aggregate samples to verify the TV submitted on a Contractor Job Mix Formula Proposal form.
2. Asphalt binder. Take at least four 1 qt samples. Each sample must be in a cylindrical-shaped can with an open top and friction lid. If the asphalt binder is modified or rubberized, the asphalt binder must be sampled with the components blended in the proportions to be used.
3. RAP. Samples must be at least 50 lb from each fractionated stockpile used or 100 lb from the belt.
4. Plant-produced HMA. The HMA samples must be at least 250 lb.

For aggregate, RAP, and HMA, split the samples into at least 4 parts and label their containers.

Submit 3 parts and keep 1 part.

After acceptance of the JMF submittal, the Engineer verifies each proposed JMF within 20 days of receiving all verification samples.

For JMF verification, the Engineer tests the following for compliance with the specifications:

1. Aggregate quality
2. Aggregate gradation
3. Voids in mineral aggregate on laboratory-produced HMA
4. HMA quality characteristics for Department acceptance

To verify the HMA for air voids, voids in mineral aggregate, and dust proportion, the Engineer uses an average of 3 briquettes. The Engineer tests plant-produced material.

If the Engineer verifies the JMF, the Engineer furnishes you a Hot Mix Asphalt Verification form.

If the Engineer's test results on plant-produced samples do not show compliance with the specifications, the Engineer notifies you. Adjust your JMF based on your testing unless the Engineer authorizes reverification without adjustments. JMF adjustments may include a change in:

1. Asphalt binder content TV up to ± 0.20 percent from the OBC value submitted on the Contractor Hot Mix Asphalt Design Data form
2. Aggregate gradation TV within the TV limits specified in the aggregate gradation table

You may adjust the JMF only once due to a failed verification test.

For each HMA type and aggregate size specified, the Engineer verifies up to 2 proposed JMF submittals including a JMF adjusted after verification failure. If you submit more than 2 JMFs for each type of HMA and aggregate size, the Engineer deducts \$3,000 from payments for each verification exceeding this limit. This deduction does not apply to verifications initiated by the Engineer or if a JMF expires while HMA production is stopped longer than 30 days.

A verified JMF is valid for 12 months.

39-2.01A(4)(c) Job Mix Formula Authorization

You may start HMA production if:

1. Engineer's review of the JMF shows compliance with the specifications
2. Department has verified the JMF within 12 months before HMA production
3. Engineer authorizes the verified JMF

39-2.01A(4)(d) Job Mix Formula Renewal

For a JMF renewal and upon request, in the Engineer's presence and from the same production run, take samples of:

1. Aggregates. Coarse, fine, and supplemental fine aggregates must be taken from the combined cold-feed belt or the hot bins. If lime treatment is required, samples must be taken from individual stockpiles before lime treatment. Samples must be at least 120 lb for each coarse aggregate, 80 lb for each fine aggregate, and 10 lb for each type of supplemental fines. For hot-bin samples, the Department combines these aggregate samples to verify the TV submitted on a Contractor Job Mix Formula Proposal form.
2. Asphalt binder. Take at least four 1 qt samples. Each sample must be in a cylindrical-shaped can with an open top and friction lid. If the asphalt binder is modified or rubberized, the asphalt binder must be sampled with the components blended in the proportions to be used.
3. RAP. Samples must be at least 50 lb from each fractionated stockpile.
4. Plant-produced HMA. The HMA samples must be at least 250 lb.

Notify the Engineer at least 2 business days before sampling materials. For aggregate, RAP, and HMA, split samples into at least 4 parts. Submit 3 parts and use 1 part for your testing.

Allow the Engineer 5 business days from a complete JMF reverification submittal for document review of the aggregate qualities, mix design, and JMF.

The most recent aggregate quality test results within the past 12 months may be used for verification of JMF renewal or upon request, the Engineer may perform aggregate quality tests for verification of JMF renewal.

The Engineer verifies the JMF for renewal under section 39-2.01A(4)(b) except:

1. Engineer keeps the samples until you provide test results for your part on a Contractor Job Mix Formula Renewal form.
2. Department tests samples of materials obtained from the HMA production unit after you submit test results that comply with the mix design specifications.
3. After completion of the JMF verification renewal document review, the Engineer verifies each proposed JMF within 20 days of receiving the verification renewal samples and the complete Contractor Job Mix Formula Renewal form.
4. You may not adjust the JMF due to a failed verification.

5. For each HMA type and aggregate gradation specified, the Engineer verifies at no cost to you 1 proposed JMF renewal within a 12-month period.

If the Engineer verifies the JMF renewal, the Engineer furnishes you a Hot Mix Asphalt Verification form. The Hot Mix Asphalt Verification form is valid for 12 months.

39-2.01A(4)(e) Job Mix Formula Modification

The Engineer verifies the modified JMF after the modified JMF HMA is placed and verification samples are taken within the first 750 tons. The Engineer tests verification samples for compliance with:

1. Hamburg wheel track mix design specifications
2. Air void content
3. Voids in mineral aggregate on plant-produced HMA mix design specifications
4. Dust proportion mix design specifications

The Engineer may test for moisture susceptibility for compliance with the mix design specifications.

If the modified JMF is verified, the Engineer revises your Hot Mix Asphalt Verification form to include the new asphalt binder source, new liquid antistriper producer, or new liquid antistriper dosage. Your revised form will have the same expiration date as the original form.

If a modified JMF is not verified, stop production and any HMA placed using the modified JMF is rejected.

The Engineer deducts \$2,000 from payments for each JMF modification.

39-2.01A(4)(f) Certifications

39-2.01A(4)(f)(i) General

Laboratories testing aggregate and HMA qualities used to prepare the mix design and JMF must be qualified under AASHTO Re:Source program and the Caltrans Independent Assurance Program.

39-2.01A(4)(f)(ii) Hot Mix Asphalt Plants

Before production, the HMA plant must have a current qualification under the Caltrans Material Plant Quality Program.

39-2.01A(4)(f)(iii)–39-2.01A(4)(f)(v) Reserved

39-2.01A(4)(g) Reserved

39-2.01A(4)(h) Quality Control

39-2.01A(4)(h)(i) General

QC test results must comply with the specifications for Department acceptance.

Prepare 3 briquettes for air voids content and voids in mineral aggregate determination. Report the average of 3 tests.

Except for smoothness, if 2 consecutive QC test results or any 3 QC test results for 1 day's production do not comply with the materials specifications:

1. Stop HMA production
2. Notify the Engineer
3. Take corrective action
4. Demonstrate compliance with the specifications before resuming production and placement

For QC tests performed under AASHTO T 27, results are considered 1 QC test regardless of number of sieves out of compliance.

Do not resume production and placement until the Engineer authorizes your corrective action proposal.

You are not entitled to compensation for the suspension of work resulting from noncompliance with quality control requirements, including those identified in the QC Plan.

39-2.01A(4)(h)(ii) Reserved
39-2.01A(4)(h)(iii) Aggregates
39-2.01A(4)(h)(iii)(A) General

Reserved

39-2.01A(4)(h)(iii)(B) Aggregate Lime Treatments

If lime treatment is required, sample coarse and fine aggregates from individual stockpiles before lime treatment. Combine aggregate in the JMF proportions. Test the aggregates under the test methods and frequencies shown in the following table:

Aggregate Quality Control During Lime Treatment

Quality characteristic	Test method	Minimum sampling and testing frequency
Sand equivalent ^{a, b}	AASHTO T 176	1 per 750 tons of untreated aggregate
Percent of crushed particles	AASHTO T 335	1 per 10,000 tons or 2 per project whichever is greater
Los Angeles Rattler	AASHTO T 96	
Fine aggregate angularity	AASHTO T 304, Method A	
Flat and elongated particles	ASTM D4791	
Fine durability index	AASHTO T 210	

^aReport test results as the average of 3 tests from a single sample.

^bUse of a sand reading indicator is required as shown in AASHTO T 176, Figure 1. Sections 4.7, "Manual Shaker," 7.1.2, "Alternate Method No. 2," 8.4.2, "Manual Shaker Method," and 8.4.3, "Hand Method," do not apply. Prepare the stock solution as specified in section 4.8.1, "Stock solution with formaldehyde," except omit the addition of formaldehyde.

For lime slurry aggregate treatment, determine the aggregate moisture content at least once every 2 hours of treatment. Calculate moisture content under AASHTO T 255 and report it as a percent of dry aggregate weight. Use the moisture content calculations as a set point for the proportioning process controller.

The device controlling lime and aggregate proportioning must produce a treatment data log. The log must consist of a series of data sets captured at 10-minute intervals throughout daily treatment. The data must be a treatment activity register and not a summation. The material represented by a data set is the quantity produced 5 minutes before and 5 minutes after the capture time. Collected data must be stored by the controller for the duration of the Contract.

If 3 consecutive sets of recorded treatment data indicate a deviation of more than 0.2 percent above or below the lime ratio in the authorized JMF, stop treatment and take corrective action.

If a set of recorded treatment data indicates a deviation of more than 0.4 percent above or below the lime ratio in the authorized JMF, stop treatment and do not use the material represented by that set of data in HMA.

If 20 percent or more of the total daily treatment indicates a deviation of more than 0.2 percent above or below the lime ratio in the authorized JMF, stop treatment and do not use that day's treated aggregate in HMA.

The Engineer may order you to stop aggregate treatment activities for any of following:

1. You fail to submit treatment data log.
2. You fail to submit aggregate QC data for marinated aggregate.

3. You submit incomplete, untimely, or incorrectly formatted data.
4. You do not take corrective actions.
5. You take late or unsuccessful corrective actions.
6. You do not stop treatment when proportioning tolerances are exceeded.
7. You use malfunctioning or failed proportioning devices.

If you stop treatment for noncompliance, notify the Engineer of any corrective actions taken and conduct a successful 20-minute test run before resuming treatment.

39-2.01A(4)(h)(iv) Liquid Antistrip Treatment

For continuous mixing or batch-plant mixing, sample asphalt binder before adding liquid antistrip. For continuous mixing, sample the combined asphalt binder and liquid antistrip after the static mixer.

39-2.01A(4)(h)(v) Production Start-up Evaluation

You and the Engineer evaluate HMA production and placement at production start-up.

Within the first 750 tons produced on the 1st day of HMA production, in the Engineer's presence, and from the same production run, take samples of:

1. Aggregates. Samples must be at least 120 lb for each coarse aggregate, 80 lb for each fine aggregate, and 10 lb for each type of supplemental fines. For hot-bin samples, the Department combines these aggregate samples.
2. Asphalt binder. Take at least four 1 qt samples. Each sample must be in a cylindrical-shaped can with an open top and friction lid. If the asphalt binder is modified or rubberized, the asphalt binder must be sampled with the components blended in the proportions to be used.
3. RAP. Samples must be at least 50 lb..
4. HMA. The HMA samples must be at least 250 lb.

Sample aggregates from the combined cold-feed belt or hot bin. Take RAP samples from the RAP system.

For aggregates, RAP, and HMA, split the samples into at least 4 parts and label their containers. Submit 3 parts and keep 1 part.

You and the Engineer must test the samples and report test results, except for AASHTO T 324 (Modified) and AASHTO T 283 test results, within 5 business days of sampling. For AASHTO T 324 (Modified) and AASHTO T 283 test results, report test results within 15 days of sampling. If you proceed before receipt of the test results, the Engineer may consider the HMA placed to be represented by these test results.

39-2.01A(4)(h)(vi) Hot Mix Asphalt Density

During HMA placement determine HMA density using a nuclear gauge. On the 1st day of production, develop a correlation factor between cores and nuclear gauge under California Test 375.

Test for in-place density using cores and a nuclear gauge. Test at random locations you select and include the test results in your QC production tests reports.

39-2.01A(4)(h)(vii) RESERVED

39-2.01A(4)(h)(viii) Density Cores

Except for HMA pavement placed using method compaction, take 4- or 6-inch diameter density cores at least once every 5 business days. Take 1 density core for every 250 tons of HMA from random locations the Engineer selects. Take density cores in the Engineer's presence, and backfill and compact holes with authorized material. Before submitting a density core, mark it with the density core's location and place it in a protective container.

If a density core is damaged, replace it with a density core taken within 1 foot longitudinally from the original density core location. Relocate any density core located within 1 foot of a rumble strip to 1 foot transversely away from the rumble strip.

For a tapered notched wedge joint, take 4- or 6-inch diameter density cores 6 inches from the upper vertical notch of the completed longitudinal joint for every 3,000 feet at locations selected by the Engineer. Take cores after the adjacent lane is placed and before opening the pavement to traffic. Take cores in the presence of the Engineer, and backfill and compact holes with authorized material. Before submitting a density core, mark it with the core's location, and place it in a protective container.

39-2.01A(4)(h)(ix) Pavement Smoothness

For HMA pavement within 3 feet from and parallel to the construction joint formed between curbs, gutters, or existing pavement, test pavement smoothness using a 12-foot straightedge.

39-2.01A(4)(h)(x) Reserved

39-2.01A(4)(i) Department Acceptance

39-2.01A(4)(i)(i) General

The Department tests treated aggregate for acceptance before lime treatment except for gradation.

The Engineer takes HMA samples for AASHTO T 283 and AASHTO T 324 (Modified) from any of the following locations:

1. Plant
2. Truck
3. Windrow

The Engineer takes HMA samples for all other tests from any of the following locations:

1. Plant
2. Truck
3. Windrow
4. Mat behind the paver

To obtain workability of the HMA sample for splitting, the Engineer reheats each sample of HMA mixture not more than 2 cycles. Each reheat cycle is performed by placing the loose mixture in a mechanical forced-draft oven for 2 hours or less after the sample reaches 140 degrees F.

The Engineer splits samples and provides you with a part if you request this.

No single aggregate or HMA test result may represent more than 750 tons or one day's production, whichever is less, except AASHTO T 283 and AASHTO T 324 (Modified).

Except for smoothness, if 2 consecutive Department acceptance test results or any 3 Department acceptance test results for 1 day's production do not comply with the specifications:

1. Stop HMA production
2. Take corrective action
3. Demonstrate compliance with the specifications before resuming production and placement

For Department acceptance tests performed under AASHTO T 27, results are considered 1 Department acceptance test regardless of the number of sieves out of compliance.

The Engineer accepts HMA based on:

1. Authorized JMF
2. Authorized QC plan
3. Asphalt binder compliance
4. Asphalt emulsion compliance

- 5. Visual inspection
- 6. Pavement smoothness

39-2.01A(4)(i)(ii) In-Place Density

Except for HMA pavement placed using method compaction, the Engineer tests the density core you take from each 250 tons of HMA. The Engineer determines the percent of theoretical maximum density for each density core by determining the density core's density and dividing by the theoretical maximum density.

Density cores must be taken from the final layer, cored through the entire pavement thickness shown. Where OGFC is required, take the density cores before placing OGFC.

If the percent of theoretical maximum density does not comply with the specifications, the Engineer may accept the HMA and take a payment deduction as shown in the following table:

Reduced Payment Factors for Percent of Maximum Theoretical Density

HMA percent of maximum theoretical density	Reduced payment factor	HMA percent of maximum theoretical density	Reduced payment factor
91.0	0.0000	97.0	0.0000
90.9	0.0125	97.1	0.0125
90.8	0.0250	97.2	0.0250
90.7	0.0375	97.3	0.0375
90.6	0.0500	97.4	0.0500
90.5	0.0625	97.5	0.0625
90.4	0.0750	97.6	0.0750
90.3	0.0875	97.7	0.0875
90.2	0.1000	97.8	0.1000
90.1	0.1125	97.9	0.1125
90.0	0.1250	98.0	0.1250
89.9	0.1375	98.1	0.1375
89.8	0.1500	98.2	0.1500
89.7	0.1625	98.3	0.1625
89.6	0.1750	98.4	0.1750
89.5	0.1875	98.5	0.1875
89.4	0.2000	98.6	0.2000
89.3	0.2125	98.7	0.2125
89.2	0.2250	98.8	0.2250
89.1	0.2375	98.9	0.2375
89.0	0.2500	99.0	0.2500
<89.0	Remove and replace	>99.0	Remove and replace

For acceptance of a completed tapered notched wedge joint, the Engineer determines density from cores you take every 3,000 feet.

39-2.01A(4)(i)(iii) RESERVED

39-2.01A(4)(i)(iv) Dispute Resolution

You and the Engineer must work together to avoid potential conflicts and to resolve disputes regarding test result discrepancies. Notify the Engineer within 5 business days of receiving a test result if you dispute the test result.

If you or the Engineer dispute the other's test results, submit your test results and copies of paperwork including worksheets used to determine the disputed test results. An independent third party performs referee testing. Before the third party participates in a dispute resolution, it must be qualified under AASHTO Materials Reference Laboratory program, and the Caltrans' Independent Assurance Program.

The independent third party must have no prior direct involvement with this Contract. By mutual agreement, the independent third party is chosen from:

1. Caltrans laboratory in a district or region not in the district or region the project is located
2. Caltrans Transportation Laboratory
3. Laboratory not currently employed by you or your HMA producer

If the Department's portion of the split QC samples or acceptance samples are not available, the independent third party uses any available material representing the disputed HMA for evaluation.

For a dispute involving JMF verification, the independent third party performs referee testing as specified in the 5th paragraph of section 39-2.01A(4)(b).

If the independent third party determines the Department's test results are valid, the Engineer deducts the independent third party's testing costs from payments. If the independent third party determines your test results are valid, the Department pays the independent third party's testing costs.

39-2.01B Materials

39-2.01B(1) General

Reserved

39-2.01B(2) Mix Design

39-2.01B(2)(a) General

The HMA mix design must comply with the Superpave HMA mix design as described in MS-2 Asphalt Mix Design Methods by the Asphalt Institute.

The Contractor Hot Mix Asphalt Design Data form must show documentation on aggregate quality.

39-2.01B(2)(b) Hot Mix Asphalt Treatments

If the proposed JMF indicates that the aggregate is being treated with dry lime or lime slurry with marination, or the HMA with liquid antistripping, then testing the untreated aggregate under AASHTO T 283 and AASHTO T 324 is not required.

If HMA treatment is required or being used by the Contractor, determine the plasticity index of the aggregate blend under California Test 204.

Do not use an aggregate blend with a plasticity index greater than 10.

If the plasticity index is from 4 to 10, treat the aggregate blend with dry lime with marination or lime slurry with marination.

If the plasticity index is less than 4, treat the aggregate blend with dry lime or lime slurry with marination, or treat the HMA with liquid antistripping.

39-2.01B(2)(c) Warm Mix Asphalt Technology

For HMA with WMA additive technology, produce HMA mix samples for your mix design using your methodology for inclusion of WMA admixture in laboratory-produced HMA. Cure the samples in a forced-air draft oven at 275 degrees F for 4 hours ± 10 minutes.

For WMA water injection foam technology, the use of foamed asphalt for mix design is not required.

39-2.01B(3) Asphalt Binder

Asphalt binder must comply with section 92.

For a leveling course, the grade of asphalt binder for the HMA must be PG 64-10 or PG 64-16.

39-2.01B(4) Aggregates

39-2.01B(4)(a) General

Aggregates must be clean and free from deleterious substances.

The aggregates for a leveling course must comply with the grading specifications for Type A HMA in section 39-2.02B(4)(b).

39-2.01B(4)(b) Aggregate Gradations

Aggregate gradation must be determined before the addition of asphalt binder and must include supplemental fine aggregates. Test for aggregate gradation under AASHTO T 27. Do not wash the coarse aggregate. Wash the fine aggregate only. Use a mechanical sieve shaker. Aggregate shaking time must not exceed 10 minutes for each coarse and fine aggregate portion.

Choose a TV within the TV limits shown in the tables titles “Aggregate Gradation for Type A HMA (Percentage Passing)”.

Gradations are based on nominal maximum aggregate size.

39-2.01B(4)(c) Aggregate Lime Treatments

39-2.01B(4)(c)(i) General

If aggregate lime treatment is required as specified in section 39-2.01B(2)(b), the virgin aggregate must comply with the aggregate quality specifications.

Lime for treating aggregate must comply with section 24-2.02.

Water for lime treatment of aggregate with lime slurry must comply with section 24-1.02B.

Notify the Engineer at least 24 hours before the start of aggregate treatment.

Do not treat RAP.

The lime ratio is the pounds of dry lime per 100 lb of dry virgin aggregate expressed as a percentage. Water content of slurry or untreated aggregate must not affect the lime ratio.

Coarse and fine aggregate fractions must have the lime ratio ranges shown in the following table:

Aggregate fractions	Lime ratio percent
Coarse	0.4–1.0
Fine	1.5–2.0
Combined	0.8–1.5

The lime ratio for fine and coarse aggregate must be within ± 0.2 percent of the lime ratio in the accepted JMF. The lime ratio must be within ± 0.2 percent of the authorized lime ratio when you combine the individual aggregate sizes in the JMF proportions. The lime ratio must be determined before the addition of RAP.

If marination is required, marinate treated aggregate in stockpiles from 24 hours to 60 days before using in HMA. Do not use aggregate marinated longer than 60 days.

Treated aggregate must not have lime balls or clods.

39-2.01B(4)(c)(ii) Dry Lime

If marination is required:

1. Treat and marinate coarse and fine aggregates separately
2. Treat the aggregate and stockpile for marination only once
3. Treat the aggregate separately from HMA production

Proportion dry lime by weight with an automatic continuous proportioning system.

If you use a batch-type proportioning system for HMA production, control proportioning in compliance with the specifications for continuous mixing plants. Use a separate dry lime aggregate treatment system for HMA batch mixing including:

1. Pugmill mixer
2. Controller
3. Weigh belt for the lime
4. Weigh belt for the aggregate

If a continuous mixing plant for HMA production without lime-marinated aggregates is used, use a controller that measures the blended aggregate weight after any additional water is added to the mixture. The controller must determine the quantity of lime added to the aggregate from the aggregate weigh belt input in connection with the manually input total aggregate moisture, the manually input target lime content, and the lime proportioning system output. Use a continuous aggregate weigh belt and pugmill mixer for lime treatment in addition to the weigh belt for the aggregate proportioning to asphalt binder in the HMA plant. If you use a water meter for moisture control for lime treatment, the meter must comply with Caltrans' *MPQP* manual.

When mixing dry lime with aggregate, the aggregate moisture content must ensure complete lime coating. The aggregate moisture content must not cause aggregate to be lost between the point of weighing the combined aggregate continuous stream and the dryer. Add water to the aggregate for mixing and coating before dry lime addition. Immediately before mixing lime with aggregate, water must not visibly separate from the aggregate.

Mix aggregate, water, and dry lime with a continuous pugmill mixer with twin shafts. Immediately before mixing lime with aggregate, water must not visibly separate from the aggregate. Store dry lime in a uniform and free-flowing condition. Introduce dry lime to the pugmill in a continuous process. The introduction must occur after the aggregate cold feed and before the point of proportioning across a weigh belt and the aggregate dryer. Prevent loss of dry lime.

The pugmill must be equipped with paddles arranged to provide sufficient mixing action and mixture movement. The pugmill must produce a homogeneous mixture of uniformly coated aggregates at mixer discharge.

If the aggregate treatment process is stopped longer than 1 hour, clean the equipment of partially treated aggregate and lime.

Aggregate must be completely treated before introduction into the mixing drum.

39-2.01B(4)(c)(iii) Lime Slurry

For lime slurry aggregate treatment, treat aggregate separate from HMA production. Stockpile and marinate the aggregate.

Proportion lime and water with a continuous or batch mixing system.

Add lime to the aggregate as slurry consisting of mixed dry lime and water at a ratio of 1 part lime to from 2 to 3 parts water by weight. The slurry must completely coat the aggregate.

Immediately before mixing lime slurry with the aggregate, water must not visibly separate from the aggregate.

Proportion lime slurry and aggregate by weight in a continuous process.

39-2.01B(5) Liquid Antistrip Treatment

Liquid antistrip must be from 0.25 to 1.0 percent by weight of asphalt binder. Do not use liquid antistrip as a substitute for asphalt binder.

Liquid antistrip total amine value must be 325 minimum when tested under ASTM D2074.

Use only 1 liquid antistrip type or brand at a time. Do not mix liquid antistrip types or brands.

Store and mix liquid antistrip under the manufacturer's instructions.

39-2.01B(6)–39-2.01B(7) Reserved

39-2.01B(8) Hot Mix Asphalt Production

39-2.01B(8)(a) General

Do not start HMA production before verification and authorization of JMF.

The HMA plant must have a current qualification under Caltrans' Material Plant Quality Program.

Weighing and metering devices used for the production of HMA modified with additives must comply with Caltrans' *MPQP*. If a loss-in-weight meter is used for dry HMA additive, the meter must have an automatic and integral material delivery control system for the refill cycle.

Calibrate the loss-in-weight meter by:

1. Including at least 1 complete system refill cycle during each calibration test run
2. Operating the device in a normal run mode for 10 minutes immediately before starting the calibration process
3. Isolating the scale system within the loss-in-weight feeder from surrounding vibration
4. Checking the scale system within the loss-in-weight feeder for accuracy before and after the calibration process and daily during mix production
5. Using a minimum 15 minute or minimum 250 lb test run size for a dry ingredient delivery rate of less than 1 ton per hour.
6. Complying with the limits of Table B, "Conveyor Scale Testing Extremes," in Caltrans' *MPQP*

Proportion aggregate by hot or cold-feed control.

Aggregate temperature must not be more than 375 degrees F when mixed with the asphalt binder.

Asphalt binder temperature must be from 275 to 375 degrees F when mixed with aggregate.

Mix HMA ingredients into a homogeneous mixture of coated aggregates.

HMA must be produced at the temperatures shown in the following table:

HMA Production Temperatures	
HMA compaction	Temperature (°F)
HMA	
Density based	≤ 325
Method	305–325
HMA with WMA technology	
Density based	240–325
Method	260–325

If you stop production for longer than 30 days, a production start-up evaluation is required.

39-2.01B(8)(b) Liquid Antistrip

If 3 consecutive sets of recorded production data show that the actual delivered liquid antistrip weight is more than ±1 percent of the authorized mix design liquid antistrip weight, stop production and take corrective action.

If a set of recorded production data shows that the actual delivered liquid antistrip weight is more than ±2 percent of the authorized mix design liquid antistrip weight, stop production. If the liquid antistrip weight exceeds 1.2 percent of the asphalt binder weight, do not use the HMA represented by that data.

The continuous mixing plant controller proportioning the HMA must produce a production data log. The log must consist of a series of data sets captured at 10-minute intervals throughout daily production. The data must be a production activity register and not a summation. The material represented by the data is

the quantity produced 5 minutes before and 5 minutes after the capture time. For the duration of the Contract, the collected data must be stored by the plant controller or a computer's memory at the plant.

The Engineer orders proportioning activities stopped for any of the following reasons:

1. You fail to submit data
2. You submit incomplete, untimely, or incorrectly formatted data
3. You fail to take corrective actions
4. You take late or unsuccessful corrective actions
5. You fail to stop production when proportioning tolerances are exceeded
6. You use malfunctioning or failed proportioning devices

If you stop production, notify the Engineer of any corrective actions taken before resuming.

39-2.01B(8)(c) Warm Mix Asphalt Technology

Proportion all ingredients by weight. The HMA plant process controller must be the sole source of ingredient proportioning control and be fully interfaced with all scales and meters used in the production process. The addition of the HMA additive must be controlled by the plant process controller.

Liquid ingredient additive, including a normally dry ingredient made liquid, must be proportioned with a mass flow meter at continuous mixing plants. Use a mass flow meter or a container scale to proportion liquid additives at batch mixing plants.

Continuous mixing plants using HMA additives must comply with the following:

1. Dry ingredient additives for continuous production must be proportioned with a conveyor scale or a loss-in-weight meter.
2. HMA plant process controller and ingredient measuring systems must be capable of varying all ingredient-feed rates proportionate with the dry aggregate delivery at all production rates and rate changes.
3. Liquid HMA additive must enter the production stream with the binder. Dry HMA additive must enter the production stream at or before the mixing area.
4. If dry HMA additives are used at continuous mixing HMA plants, bag-house dust systems must return all captured material to the mix. This requirement is waived for lime-treated aggregates.
5. HMA additive must be proportioned to within ± 0.3 percent of the target additive rate.

Batch mixing plants using HMA additives must comply with the following:

1. Metered HMA additive must be placed in an intermediate holding vessel before being added to the stream of asphalt binder as it enters the pugmill.
2. If a container scale is used, weigh additive before combining with asphalt binder. Keep the container scale separate from other ingredient proportioning. The container scale capacity must be no more than twice the volume of the maximum additive batch size. The container scale's graduations must be smaller than the proportioning tolerance or 0.001 times the container scale capacity.
3. Dry HMA additive proportioning devices must be separate from metering devices for the aggregates and asphalt binder. Proportion dry HMA additive directly into the pugmill, or place in an intermediate holding vessel to be added to the pugmill at the appropriate time in the batch cycle. Dry ingredients for batch production must be proportioned with a hopper scale.
4. Zero tolerance for the HMA additive batch scale is ± 0.5 percent of the target additive weight. The indicated HMA additive batch scale weight may vary from the preselected weight setting by up to ± 1.0 percent of the target additive weight.

39-2.01B(9) Geosynthetic Pavement Interlayer

Geosynthetic pavement interlayer must comply with the specifications for pavement fabric, paving mat, paving grid, paving geocomposite grid, or geocomposite strip membrane as shown.

The asphalt binder for geosynthetic pavement interlayer must be PG 64-10, PG 64-16, or PG 70-10.

39-2.01B(10) Tack Coat

Tack coat must comply with the specifications for asphaltic emulsion or asphalt binder. Choose the type and grade of emulsion or binder.

39-2.01B(11) Miscellaneous Areas , Dikes, & Berms

For miscellaneous areas, dikes, and berms:

1. Use Minor HMA.
2. Choose the aggregate gradation from:
 - 2.1. 3/8-inch Type A HMA aggregate gradation
 - 2.2. 1/2-inch Type A HMA aggregate gradation
 - 2.3. dike mix aggregate gradation
3. Choose asphalt binder Grade PG 64-10, PG 64-16 or PG 70-10.
4. Minimum asphalt binder content must be:
 - 4.1. 6.40 percent for 3/8-inch Type A HMA aggregate gradation
 - 4.2. 5.70 percent for 1/2-inch Type A HMA aggregate gradation
 - 4.3. 6.00 percent for dike mix aggregate gradation

If you request and the Engineer authorizes, you may reduce the minimum asphalt binder content.

Aggregate gradation for dike mix must be within the TV limits for the specified sieve size shown in the following table:

**Dike Mix Aggregate Gradation
(Percentage Passing)**

Sieve size	Target value limit	Allowable tolerance
1/2"	100	--
3/8"	---	95 - 100
No. 4	73-77	TV ± 10
No. 8	58-63	TV ± 10
No. 30	29-34	TV ± 10
No. 200		0 - 14

For HMA used in miscellaneous areas, dikes, and berms, sections 39-2.01A(3), 39-2.01A(4), 39-2.01B(2), 39-2.01B(4)(c), and 39-2.01B(5)-(10) do not apply.

39-2.01C Construction

39-2.01C(1) General

Do not place HMA on wet pavement or frozen surface.

You may deposit HMA in a windrow and load it in the paver if:

1. Paver is equipped with a hopper that automatically feeds the screed
2. Loading equipment can pick up the windrowed material and deposit it in the paver hopper without damaging base material
3. Activities for depositing, pickup, loading, and paving are continuous
4. For method compaction:
 - 4.1. The temperature of the HMA and the HMA produced with WMA water injection technology in the windrow does not fall below 260 degrees F
 - 4.2. The temperature of the HMA produced using WMA additive technology in the windrow does not fall below 250 degrees F

HMA placed in a windrow on the roadway surface must not extend more than 250 feet in front of the loading equipment or material transfer vehicle.

You may place HMA in 1 or more layers on areas less than 5 feet wide and outside the traveled way, including shoulders. You may use mechanical equipment other than a paver for these areas. The equipment must produce uniform smoothness and texture.

HMA handled, spread, or windrowed must not stain the finished surface of any improvement, including pavement.

Do not use petroleum products such as kerosene or diesel fuel to release HMA from trucks, spreaders, or compactors.

HMA must be free of:

1. Segregation
2. Coarse or fine aggregate pockets
3. Hardened lumps
4. Marks
5. Tearing
6. Irregular Texture

Complete finish rolling activities before the pavement surface temperature is:

1. Below 150 degrees F for HMA with unmodified binder
2. Below 140 degrees F for HMA with modified binder

39-2.01C(2) Spreading and Compacting Equipment

39-2.01C(2)(a) General

Paving equipment for spreading must be:

1. Self-propelled
2. Mechanical
3. Equipped with a screed or strike-off assembly that can distribute HMA the full width of a traffic lane
4. Equipped with a full-width compacting device
5. Equipped with automatic screed controls and sensing devices that control the thickness, longitudinal grade, and transverse screed slope

Install and maintain grade and slope references.

The screed must be heated and produce a uniform HMA surface texture without tearing, shoving, or gouging.

The paver must not leave marks such as ridges and indentations unless you can eliminate them by rolling.

Rollers must be equipped with a system that prevents HMA from sticking to the wheels. You may use a parting agent that does not damage the HMA or impede the bonding of layers.

In areas inaccessible to spreading and compacting equipment:

1. Spread the HMA by any means to obtain the specified lines, grades, and cross sections
2. Use a pneumatic tamper, plate compactor, or equivalent to achieve thorough compaction

39-2.01C(2)(b) Material Transfer Vehicle

If a material transfer vehicle is specified, the material transfer vehicle must have sufficient capacity to prevent stopping the paver and must be capable of:

1. Either receiving HMA directly from trucks or using a windrow pickup head to load it from a windrow deposited on the roadway surface
2. Remixing the HMA with augers before transferring into the paver's receiving hopper or feed system
3. Transferring HMA directly into the paver's receiving hopper or feed system

39-2.01C(2)(c) Method Compaction Equipment

For method compaction, each paver spreading HMA must be followed by at least one of each of the following 3 types of rollers:

1. Breakdown roller must be a vibratory roller specifically designed to compact HMA. The roller must be capable of at least 2,500 vibrations per minute and must be equipped with amplitude and frequency controls. The roller's gross static weight must be at least 7.5 tons.
2. Intermediate roller must be an oscillating-type pneumatic-tired roller at least 4 feet wide. Pneumatic tires must be of equal size, diameter, type, and ply. The tires must be inflated to 60 psi minimum and maintained so that the air pressure does not vary more than 5 psi.
3. Finishing roller must be a steel-tired, 2-axle tandem roller. The roller's gross static weight must be at least 7.5 tons.

Each roller must have a separate operator. Rollers must be self-propelled and reversible.

39-2.01C(2)(d)–39-2.01C(2)(f) Reserved

39-2.01C(3) Surface Preparation

39-2.01C(3)(a) General

Before placing HMA, remove loose paving particles, dirt, and other extraneous material by any means including flushing and sweeping.

39-2.01C(3)(b) Subgrade

Prepare subgrade to receive HMA under the sections for the material involved. Subgrade must be free of loose and extraneous material.

39-2.01C(3)(c) Reserved

39-2.01C(3)(d) Reserved

39-2.01C(3)(e) Reserved

39-2.01C(3)(f) Tack Coat

Apply a tack coat:

1. To existing pavement including planed surfaces
2. Between HMA layers
3. To vertical surfaces of:
 - 3.1. Curbs
 - 3.2. Gutters
 - 3.3. Construction joints

Equipment for the application of tack coat must comply with section 37-1.03B.

Before placing HMA, apply a tack coat in 1 application at the minimum residual rate shown in the following table for the condition of the underlying surface:

Tack Coat Application Rates for HMA

HMA over:	Minimum residual rates (gal/sq yd)		
	CSS1/CSS1h, SS1/SS1h and QS1h/CQS1h asphaltic emulsion	CRS1/CRS2, RS1/RS2 and QS1/CQS1 asphaltic emulsion	Asphalt binder and PMRS2/PMCRS2 and PMRS2h/PMCRS2h asphaltic emulsion
New HMA (between layers)	0.02	0.03	0.02
Concrete pavement and existing asphalt concrete surfacing	0.03	0.04	0.03
Planed pavement	0.05	0.06	0.04

If a stress absorbing membrane interlayer as specified in section 37-2.05 is applied, the tack coat application rates for new HMA apply.

Notify the Engineer if you dilute asphaltic emulsion with water. The weight ratio of added water to asphaltic emulsion must not exceed 1 to 1.

Measure added water either by weight or volume under section 9-1.02 or use water meters from water districts, cities, or counties. If you measure water by volume, apply a conversion factor to determine the correct weight.

With each dilution, submit:

1. Weight ratio of water to bituminous material in the original asphaltic emulsion
2. Weight of asphaltic emulsion before diluting
3. Weight of added water
4. Final dilution weight ratio of water to asphaltic emulsion

Apply a tack coat to vertical surfaces with a residual rate that will thoroughly coat the vertical face without running off.

If authorized, you may:

1. Change tack coat rates
2. Omit tack coat between layers of new HMA during the same work shift if:
 - 2.1. No dust, dirt, or extraneous material is present
 - 2.2. Surface is at least 140 degrees F

Immediately in advance of placing HMA, apply additional tack coat to damaged areas or where loose or extraneous material is removed.

Close areas receiving tack coat to traffic. Do not allow the tracking of tack coat onto pavement surfaces beyond the job site.

If you use an asphalt binder for tack coat, the asphalt binder temperature must be from 285 to 350 degrees F when applied.

39-2.01C(3)(g) Geosynthetic Pavement Interlayer

Where shown, place geosynthetic pavement interlayer over a coat of asphalt binder and in compliance with the manufacturer's instructions. Do not place the interlayer on a wet or frozen surface. If the interlayer, in compliance with the manufacturer's instructions, does not require asphalt binder, do not apply asphalt binder before placing the interlayer.

Before placing the interlayer or asphalt binder:

1. Clean the pavement of loose and extraneous material.

If the interlayer requires asphalt binder, immediately before placing the interlayer, apply asphalt binder at a rate specified by the interlayer manufacturer; at 0.25 ± 0.03 gal per square yard of interlayer; or at a rate that just saturates the interlayer; whichever is greater. Apply asphalt binder the width of the interlayer plus 3 inches on each side. At an interlayer overlap, apply asphalt binder on the lower interlayer the same overlap distance as the upper interlayer.

If asphalt binder tracked onto the interlayer or brought to the surface by construction equipment causes interlayer displacement, cover it with a small quantity of HMA.

If the interlayer placement does not require asphalt binder, apply tack coat prior to placing HMA at the application rates specified under section 39-2.01C(3)(f) based on the condition of the underlying surface on which the interlayer was placed.

Align and place the interlayer with no overlapping wrinkles, except a wrinkle that overlaps may remain if it is less than 1/2 inch thick. If the overlapping wrinkle is more than 1/2 inch thick, cut the wrinkle out and overlap the interlayer no more than 2 inches.

Overlap the interlayer borders between 2 to 4 inches. In the direction of paving, overlap the following roll with the preceding roll at any break.

You may use rolling equipment to correct distortions or wrinkles in the interlayer.

Before placing HMA on the interlayer, do not expose the interlayer to:

1. Traffic, except for crossings under traffic control and only after you place a small HMA quantity
2. Sharp turns from construction equipment
3. Damaging elements

Pave HMA on the interlayer during the same work shift. The minimum HMA thickness over the interlayer must be 0.12 foot including at conform tapers.

39-2.01C(4) Longitudinal Joints

39-2.01C(4)(a) General

Longitudinal joints in the top layer must match lane lines. Alternate the longitudinal joint offsets in the lower layers at least 0.5 foot from each side of the lane line. Other longitudinal joint placement patterns are allowed if authorized.

A vertical longitudinal joint of more than 0.15 foot is not allowed at any time between adjacent lanes open to traffic.

For an HMA thickness of 0.15 foot or less, the distance between the ends of the adjacent surfaced lanes at the end of each day's work must not be greater than can be completed in the following day of normal paving.

For an HMA thickness greater than 0.15 foot, you must place HMA on adjacent traveled way lanes or shoulder such that at the end of each work shift the distance between the ends of HMA layers on adjacent lanes is from 5 to 10 feet. Place additional HMA along the transverse edge at each lane's end and along the exposed longitudinal edges between adjacent lanes. Hand rake and compact the additional HMA to form temporary conforms. You may place kraft paper or other authorized release agent under the conform tapers to facilitate the taper removal when paving activities resume.

If placing HMA against the edge of existing pavement, saw cut or grind the pavement straight and vertical along the joint and remove extraneous material.

39-2.01C(4)(b) Tapered Notched Wedge

Not used

39-2.01C(5) Pavement Edge Treatments

Construct edge treatment on the HMA pavement as shown.

Where a tapered edge is required, use the same type of HMA used for the adjacent lane or shoulder.

The edge of roadway where the tapered edge is to be placed must have a solid base, free of debris such as loose material, grass, weeds, or mud. Grade the areas to receive the tapered edge as required.

The tapered edge must be placed monolithic with the adjacent lane or shoulder and must be shaped and compacted with a device attached to the paver.

The device must be capable of shaping and compacting HMA to the required cross section as shown. Compaction must be accomplished by constraining the HMA to reduce the cross sectional area by 10 to 15 percent. The device must produce a uniform surface texture without tearing, shoving, or gouging and must not leave marks such as ridges and indentations. The device must be capable of transitioning to cross roads, driveways, and obstructions.

For the tapered edge, the angle of the slope must not deviate by more than ± 5 degrees from the angle shown. Measure the angle from the plane of the adjacent finished pavement surface.

If paving is done in multiple lifts, the tapered edge must be placed with each lift.

Short sections of hand work are allowed to construct tapered edge transitions.

The test section:

1. Must not be less than 0.1 mile in length.
2. Must have a width equal to the width of the pavement and tapered edge to be paved in one pass during production.
3. Locations shall be proposed by the Contractor and approved by the Engineer.

The test section must be constructed with asphalt paver fitted with one of the following FHWA-approved tapered edge devices:

1. **“Shoulder Wedge Maker”** manufactured by Transtech Systems, Inc., 1594 State Street, Schenectady, NY 12304, Telephone 1-800-724-6306 or 518-370-5558
2. **“Advant-Edger”** manufactured by Advant-Edge Paving Equipment LLC, 33 Old Niskayuna Road, Loudonville, NY 12211, Telephone 814-422-3343
3. **“Ramp Champ”** manufactured by Advant-Edge Paving Equipment LLC, 33 Old Niskayuna Road, Loudonville, NY 12211, Telephone 814-422-3343
4. **“SafeTSlope”** manufactured by Troxler Electronic Laboratories, Inc., 3008 E. Cornwallis Rd. Research Triangle Park, NC 27709, Telephone 877-876-9537

Comply with manufacturer's instructions for attaching the device(s) to the paver. The Engineer accepts the use of selected tapered edge device when edge shape and compaction of the test section are in compliance with plans and specifications. No further paving operations which include the construction of the tapered edge shall commence unless means and methods for constructing the tapered edge are approved by the Engineer.

39-2.01C(6) Widening Existing Pavement

If widening existing pavement, construct new pavement structure to match the elevation of the existing pavement's edge before placing HMA over the existing pavement.

39-2.01C(7) Shoulders, Medians, and Other Road Connections

Until the adjoining through lane's top layer has been paved, do not pave the top layer of:

1. Shoulders
2. Tapers
3. Transitions
4. Road connections
5. Driveways
6. Curve widenings
7. Chain control lanes
8. Turnouts
9. Turn pockets

If the number of lanes changes, pave each through lane's top layer before paving a tapering lane's top layer. Simultaneous to paving a through lane's top layer, you may pave an adjoining area's top layer, including shoulders. Do not operate spreading equipment on any area's top layer until completing final compaction.

If shoulders or median borders are shown, pave shoulders and median borders adjacent to the lane before opening a lane to traffic.

If shoulder conform tapers are shown, place conform tapers concurrently with the adjacent lane's paving.

If a driveway or a road connection is shown, place additional HMA along the pavement's edge to conform to road connections and driveways. Hand rake, if necessary, and compact the additional HMA to form a smooth conform taper.

New paving shall tie smoothly into previously resurfaced mats, existing pavement and to private drives. Place additional HMA along the pavement's edge to conform to private drives and private road connections as shown in the Project Details.

Hand rake, if necessary, and compact the additional HMA to form a smooth conform taper.

Feather down the HMA to zero thickness at the approximate rate of 20 feet per 0.08-foot thickness at all match lines across the travel lanes including the beginning and end of construction and at all intersections unless otherwise shown or described in the Project Details and as directed by the Engineer.

39-2.01C(8) Leveling

Section 39-2.01C(8) applies if a bid item for hot mix asphalt (leveling) is shown on the Bid Item List.

Fill and level irregularities and ruts with HMA before spreading HMA over the base, existing surfaces, or bridge decks. You may use mechanical equipment other than a paver for these areas. The equipment must produce uniform smoothness and texture. HMA used to change an existing surface's cross slope or profile is not paid for as hot mix asphalt (leveling).

39-2.01C(9) Miscellaneous Areas , Dikes, & Berms

Prepare the area to receive HMA for miscellaneous areas , dikes, and berms, including excavation and backfill as needed.

Spread the HMA in miscellaneous areas in 1 layer and compact to the specified lines and grades.

In median areas adjacent to slotted median drains, each layer of HMA must not exceed 0.20 foot maximum compacted thickness.

The finished surface must be:

1. Textured uniformly
2. Compacted firmly
3. Without depressions, humps, and irregularities

39-2.01C(10)–39-2.01C(14) Reserved

39-2.01C(15) Compaction

39-2.01C(15)(a) General

Rolling must leave the completed surface compacted and smooth without tearing, cracking, or shoving.

If a vibratory roller is used as a finish roller, turn the vibrator off.

Do not open new HMA pavement to traffic until its mid depth temperature is below 160 degrees F.

If the surface to be paved is both in sunlight and shade, pavement surface temperatures are taken in the shade.

39-2.01C(15)(b) Method Compaction

Use method compaction for all conditions.

HMA compaction coverage is the number of passes needed to cover the paving width. A pass is 1 roller's movement parallel to the paving in either direction. Overlapping passes are part of the coverage being made and are not a subsequent coverage. Do not start a coverage until completing the prior coverage.

Method compaction must consist of performing:

1. Breakdown compaction of each layer with 3 coverages using a vibratory roller. The speed of the vibratory roller in miles per hour must not exceed the vibrations per minute divided by 1,000. If the HMA layer thickness is less than 0.08 foot, turn the vibrator off.
2. Intermediate compaction of each layer of HMA with 3 coverages using a pneumatic-tired roller at a speed not to exceed 5 mph.
3. Finish compaction of HMA with 1 coverage using a steel-tired roller.

Start rolling at the lower edge and progress toward the highest part.

The Engineer may order fewer coverages if the layer thickness of HMA is less than 0.15 foot.

The compacted lift thickness must not exceed 0.25 foot.

39-2.01C(15)(c)–39-2.01C(15)(e) Reserved

39-2.01C(16) Smoothness Corrections

If the pavement surface does not comply with section 39-2.01A(4)(i)(iii), grind the pavement to within specified tolerances, remove and replace the pavement, or place an overlay of HMA. Do not start corrective work until your method is authorized.

Do not use equipment with carbide cutting teeth to grind the pavement unless authorized.

Smoothness corrections must leave at least 75 percent of the specified HMA thickness. If ordered, core the pavement at the locations selected by the Engineer. Coring, including traffic control, is change order work. Remove and replace deficient pavement areas where the overlay thickness is less than 75 percent of the thickness specified.

Corrected HMA pavement areas must be uniform rectangles, half the lane width, with edges:

1. Parallel to and along the nearest HMA pavement edge or lane line
2. Perpendicular to the pavement centerline

On ground areas not to be overlaid with OGFC, apply a fog seal under section 37-4.02.

Where corrections are made within areas requiring testing with inertial profiler, reprofile the entire lane length with the inertial profiler.

Where corrections are made within areas requiring testing with a 12-foot straightedge, retest the corrected area with the straightedge.

39-2.01C(17) Data Cores

Not Used.

39-2.01D Payment

The payment quantity for geosynthetic pavement interlayer is the area measured from the actual pavement covered.

Except for tack coat used in minor HMA, payment for tack coat is not included in the payment for hot mix asphalt.

The Department does not adjust the unit price for an increase or decrease in the tack coat quantity.

The payment quantity for HMA of the type shown on the Bid Item List is measured based on the combined mixture weight. If recorded batch weights are printed automatically, the bid item for HMA is measured by using the printed batch weights, provided:

1. Total aggregate and supplemental fine aggregate weight per batch is printed. If supplemental fine aggregate is weighed cumulatively with the aggregate, the total aggregate batch weight must include the supplemental fine aggregate weight.
2. Total virgin asphalt binder weight per batch is printed.
3. Each truckload's zero tolerance weight is printed before weighing the first batch and after weighing the last batch.
4. Time, date, mix number, load number and truck identification is correlated with a load slip.
5. Copy of the recorded batch weights is certified by a licensed weigh master and submitted.

The payment quantity for place hot mix asphalt dike or berm of the type shown on the Bid Item List is the length measured from end to end. Payment for the HMA used to construct the dike or berm is not included in the payment for place hot mix asphalt dike or berm.

The payment quantity for place hot mix asphalt (miscellaneous areas) is the area measured for the in-place compacted area. Payment for the HMA used for miscellaneous areas is not included in the payment for place hot mix asphalt (miscellaneous areas).

The Engineer does not adjust the unit price for an increase or decrease in the prepaving grinding day quantity.

39-2.02 TYPE A HOT MIX ASPHALT

39-2.02A General

39-2.02A(1) Summary

Section 39-2.02 includes specifications for producing and placing Type A hot mix asphalt.

You may produce Type A HMA using an authorized WMA technology.

39-2.02A(2) Definitions

Reserved

39-2.02A(3) Submittals

39-2.02A(3)(a) General

Reserved

39-2.02A(3)(b) Job Mix Formula

The JMF must be based on the superpave HMA mix design as described in *MS-2 Asphalt Mix Design Methods* by the Asphalt Institute.

39-2.02A(3)(c) Reclaimed Asphalt Pavement

Submit QC test results for RAP gradation with the combined aggregate gradation within 2 business days of taking RAP samples during Type A HMA production.

39-2.02A(3)(d)–39-2.02A(3)(f) Reserved**39-2.02A(4) Quality Assurance****39-2.02A(4)(a) General**

Reserved

39-2.02A(4)(b) Quality Control**39-2.02A(4)(b)(i) General**

Reserved

39-2.02A(4)(b)(ii) Aggregates

Test the quality characteristics of aggregates under the test methods and frequencies shown in the following table:

Aggregate Testing Frequencies

Quality characteristic	Test method	Minimum testing frequency
Gradation ^a	AASHTO T 27	1 per 750 tons and any remaining part
Sand equivalent ^{b, c}	AASHTO T 176	
Moisture content ^d	AASHTO T 255	
Crushed particles	AASHTO T 335	1 per 10,000 tons or 2 per project whichever is greater
Los Angeles Rattler	AASHTO T 96	
Flat and elongated particles	ASTM D4791	
Fine aggregate angularity	AASHTO T 304 Method A	
Coarse durability index	AASHTO T 210	1 per 3,000 or 1 per paving day, whichever is greater
Fine durability index	AASHTO T 210	

^aIf RAP is used, test the combined aggregate gradation under California Test 384.

^bReported value must be the average of 3 tests from a single sample.

^cUse of a sand reading indicator is required as shown in AASHTO T 176, Figure 1. Sections 4.7, "Manual Shaker," 7.1.2, "Alternate Method No. 2," and 8.4.3, "Hand Method," do not apply. Prepare the stock solution as specified in section 4.8.1, "Stock solution with formaldehyde," except omit the addition of formaldehyde.

^dTest at continuous mixing plants only. If RAP is used, test the RAP moisture content at continuous mixing plant and batch mixing plant.

For lime treated aggregate, test aggregate before treatment and test for gradation and moisture content during HMA production.

39-2.02A(4)(b)(iii) Reclaimed Asphalt Pavement

Sample and test processed RAP at a minimum frequency of 1 sample per 1,000 tons with a minimum of 6 samples per fractionated stockpile. If the fractionated stockpile has not been augmented, the 3 RAP samples taken and tested for mix design can be part of this minimum sample requirement. If a processed RAP stockpile is augmented, sample and test processed RAP quality characteristics at a minimum frequency of 1 sample per 500 tons of augmented RAP.

The combined RAP sample when tested under AASHTO T 164 must be within ± 2.00 percent of the average asphalt binder content reported on page 4 of your Contractor Hot Mix Asphalt Design Data form. If a new processed RAP stockpile is required, the average binder content of the new processed RAP stockpile must be within ± 2.00 percent of the average binder reported on page 4 of your Contractor Hot Mix Asphalt Design Data form.

The combined RAP sample when tested under AASHTO T 209 must be within ± 0.06 of the average maximum specific gravity reported on page 4 of your Contractor Hot Mix Asphalt Design Data form.

During Type A HMA production, sample RAP twice daily and perform QC testing for:

1. Aggregate gradation at least once a day under California Test 384
2. Moisture content at least twice a day

39-2.02A(4)(b)(iv)–39-2.02A(4)(b)(viii) Reserved

39-2.02A(4)(b)(ix) Type A Hot Mix Asphalt Production

Test the quality characteristics of Type A HMA under the test methods and frequencies shown in the following table:

Type A HMA Production Testing Frequencies

Quality characteristic	Test method	Minimum testing frequency
Asphalt binder content	AASHTO T 308, Method A	1 per 750 tons and any remaining part
HMA moisture content	AASHTO T 329	1 per 2,500 tons but not less than 1 per paving day
Air voids content	AASHTO T 269	1 per 4,000 tons or 2 every 5 paving days, whichever is greater
Voids in mineral aggregate	MS-2MS-2 Asphalt Mixture Volumetrics	1 per 10,000 tons or 2 per project whichever is greater
Dust proportion	MS-2MS-2 Asphalt Mixture Volumetrics	
Density of core	California Test 375	2 per paving day
Nuclear gauge density	California Test 375	3 per 250 tons or 3 per paving day, whichever is greater
Hamburg wheel track	AASHTO T 324 (Modified)	1 per 10,000 tons or 1 per project, whichever is greater
Moisture susceptibility	AASHTO T 283	

39-2.02A(4)(c)–39-2.02A(4)(d) Reserved

39-2.02A(4)(e) Department Acceptance

The Department accepts Type A HMA based on compliance with:

1. Aggregate quality requirements shown in the following table:

Aggregate Quality

Quality characteristic	Test method	Requirement
Aggregate gradation ^a	AASHTO T 27	JMF ± Tolerance
Percent of crushed particles	AASHTO T 335	95
Coarse aggregate (min, %)		
One-fractured face		90
Two-fractured faces		
Fine aggregate (min, %)		
(Passing No. 4 sieve		
and retained on No. 8 sieve.)		
One-fractured face		70
Los Angeles Rattler (max, %)	AASHTO T 96	12
Loss at 100 Rev.		
Loss at 500 Rev.		40
Sand equivalent (min.) ^{b, c}	AASHTO T 176	47
Flat and elongated particles (max, % by weight at 5:1)	ASTM D4791	10
Fine aggregate angularity (min, %) ^d	AASHTO T 304, Method A	45
Coarse durability index (D _c , min)	AASHTO T 210	65
Fine durability index (D _f , min)	AASHTO T 210	50

^aThe Engineer determines combined aggregate gradations containing RAP under California Test 384.

^bReported value must be the average of 3 tests from a single sample.

^cUse of a sand reading indicator is required as shown in AASHTO T 176, Figure 1. Sections 4.7, "Manual Shaker," 7.1.2, "Alternate Method No. 2," 8.4.2 Manual Shaker Method, and 8.4.3, "Hand Method," do not apply. Prepare the stock solution as specified in section 4.8.1, "Stock solution with formaldehyde," except omit the addition of formaldehyde.

^dThe Engineer waives this specification if HMA contains 10 percent or less of nonmanufactured sand by weight of total aggregate. Manufactured sand is fine aggregate produced by crushing rock or gravel.

2. If RAP is used, RAP quality requirements shown in the following table:

Reclaimed Asphalt Pavement Quality

Quality characteristic	Test method	Requirement
Binder content (% within the average value reported)	AASHTO T 164	±2.00
Specific gravity (within the average value reported)	AASHTO T 209	±0.06

3. In place Type A HMA quality requirements shown in the following table:

Type A HMA Acceptance In Place

Quality characteristic	Test method	Requirement
Asphalt binder content (%)	AASHTO T 308 Method A	JMF -0.30, +0.50
HMA moisture content (max, %)	AASHTO T 329	1.00
Air voids content at N _{design} (%) ^{a, b}	AASHTO T 269	4.0 ± 1.5 (5.0 ± 1.5 for 1-inch aggregate)
Voids in mineral aggregate on laboratory-produced HMA (min, %) ^d Gradation: No. 4 3/8-inch 1/2-inch 3/4-inch 1-inch with NMAS = 1-inch with NMAS = 3/4-inch	MS-2MS-2 Asphalt Mixture Volumetrics	16.5–19.5 15.5–18.5 14.5–17.5 13.5–16.5 13.5–16.5 14.5–17.5
Voids in mineral aggregate on plant-produced HMA (min, %) ^a Gradation: No. 4 3/8-inch 1/2-inch 3/4-inch 1-inch with NMAS = 1-inch with NMAS = 3/4-inch	MS-2MS-2 Asphalt Mixture Volumetrics ^c	15.5–18.5 14.5–17.5 13.5–16.5 12.5–15.5 12.5–15.5 13.5–16.5
Dust proportion	MS-2MS-2 Asphalt Mixture Volumetrics	0.6–1.3 ^g
Density of core (% of max theoretical density) ^{e, f}	California Test 375	91.0–97.0
Hamburg wheel track (min number of passes at 0.5-inch rut depth) Binder grade: PG 58 PG 64 PG 70 PG 76 or higher	AASHTO T 324 (Modified)	10,000 15,000 20,000 25,000
Hamburg wheel track (min number of passes at inflection point) Binder grade: PG 58 PG 64 PG 70 PG 76 or higher	AASHTO T 324 (Modified)	10,000 10,000 12,500 15,000
Moisture susceptibility (min, psi, dry strength)	AASHTO T 283	100
Moisture susceptibility (min, psi, wet strength)	AASHTO T 283	70

^aPrepare 3 briquettes. Report the average of 3 tests.

^bThe Engineer determines the bulk specific gravity of each lab-compacted briquette under AASHTO T 275, Method A, and theoretical maximum specific gravity under AASHTO T 209, Method A.

^cDetermine bulk specific gravity under AASHTO T 275, Method A.

^dThe Engineer determines the laboratory-prepared Type A HMA value for only mix design verification.

^eThe Engineer determines percent of theoretical maximum density under California Test 375 except the Engineer uses:

1. AASHTO T 275 to determine in-place density of each density core
2. AASHTO T 209, Method A to determine theoretical maximum density instead of calculating test maximum density

^fThe Engineer determines theoretical maximum density under AASHTO T 209, Method A, at the frequency specified in California Test 375, part 5, section D.

^gFor lime-treated aggregates, the dust proportion requirement is 0.6–1.5.

39-2.02B Materials

39-2.02B(1) General

Reserved

39-2.02B(2) Type A Hot Mix Asphalt Mix Design

The mix design for Type A HMA must comply with the requirements shown in the following table:

Type A HMA Mix Design Requirements

Quality characteristic	Test method	Requirement
Air voids content (%)	AASHTO T 269 ^a	N _{initial} > 8.0 N _{design} = 4.0 (N _{design} = 5.0 for 1-inch aggregate) N _{max} > 2.0
Gyrations compaction (no. of gyrations)	AASHTO T 312	N _{initial} = 8 N _{design} = 85.0 N _{max} = 130
Voids in mineral aggregate (min, %) ^b Gradation: No. 4 3/8-inch 1/2-inch 3/4-inch 1-inch with NMAS = 1-inch with NMAS = 3/4-inch	MS-2 Asphalt Mixture Volumetrics	16.5–19.5 15.5–18.5 14.5–17.5 13.5–16.5 13.5–16.5 14.5–17.5
Dust proportion	MS-2 Asphalt Mixture Volumetrics	0.6–1.3
Hamburg wheel track (min number of passes at 0.5-inch rut depth) Binder grade: PG 58 PG 64 PG 70 PG 76 or higher	AASHTO T 324 (Modified) ^c	10,000 15,000 20,000 25,000
Hamburg wheel track (min number of passes at the inflection point) Binder grade: PG 58 PG 64 PG 70 PG 76 or higher	AASHTO T 324 (Modified) ^c	10,000 10,000 12,500 15,000
Moisture susceptibility, dry strength (min, psi)	AASHTO T 283 ^c	100
Moisture susceptibility, wet strength (min, psi)	AASHTO T 283 ^{c, d}	70

^aCalculate the air voids content of each specimen using AASHTO T 275, Method A, to determine bulk specific gravity. Use AASHTO T 209, Method A, to determine theoretical maximum specific gravity. Use a digital manometer and pycnometer when performing AASHTO T 209.

^bMeasure bulk specific gravity using AASHTO T 275, Method A.

^cTest plant-produced Type A HMA.

^dFreeze thaw required.

For Type A HMA mixtures using RAP, the maximum allowed binder replacement is 25.0 percent in the upper 0.2 foot exclusive of OGFC and 40.0 percent below. The binder replacement is calculated as a percentage of the approved JMF target asphalt binder content.

For Type A HMA with a binder replacement percent less than or equal to 25 percent of your specified OBC, you may request that the performance graded asphalt binder grade with upper and lower temperature classifications be reduced by 6 degrees C from the specified grade.

For Type A HMA with a binder replacement greater than 25 percent of your specified OBC and less than or equal to 40 percent of OBC, you must use a performance graded asphalt binder grade with upper and lower temperature classifications reduced by 6 degrees C from the specified grade.

39-2.02B(3) Asphalt Binder

The grade of asphalt binder for Type A HMA must be PG 64-10.

39-2.02B(4) Aggregates

39-2.02B(4)(a) General

Before the addition of asphalt binder and lime treatment, the aggregates must comply with the requirements shown in the following table:

Aggregate Quality		
Quality characteristic	Test method	Requirement
Percent of crushed particles:		
Coarse aggregate (min, %)		
One-fractured face	AASHTO T 335	95
Two-fractured faces		90
Fine aggregate (min, %)		
(Passing No. 4 sieve and retained on No. 8 sieve.)		
One-fractured face		70
Los Angeles Rattler (max, %)		
Loss at 100 Rev.	AASHTO T 96	12
Loss at 500 Rev.		40
Sand equivalent (min) ^a	AASHTO T 176	47
Flat and elongated particles (max, % by weight at 5:1)	ASTM D4791	10
Fine aggregate angularity (min, %) ^b	AASHTO T 304, Method A	45
Coarse durability index (Dc, min)	AASHTO T 210	65
Fine durability index (Df, min)	AASHTO T 210	50

^aThe reported value must be the average of 3 tests from a single sample. Use of a sand reading indicator is required as shown in AASHTO T 176, Figure 1. Sections 4.7, "Manual Shaker," 7.1.2, "Alternate Method No. 2," 8.4.2 Manual Shaker Method, and 8.4.3, "Hand Method," do not apply. Prepare the stock solution as specified in section 4.8.1, "Stock solution with formaldehyde," except omit the addition of formaldehyde.

^bThe Engineer waives this specification if the Type A HMA contains 10 percent or less of nonmanufactured sand by weight of total aggregate. Manufactured sand is fine aggregate produced by crushing rock or gravel.

39-2.02B(4)(b) Aggregate Gradations

The aggregate gradations for Type A HMA must comply with the requirements shown in the following table:

Aggregate Gradation Requirements	
Type A HMA pavement thickness shown	Gradation
0.10 foot	3/8 inch
Greater than 0.10 to less than 0.20 foot	1/2 inch
0.20 to less than 0.25 foot	3/4 inch
0.25 foot or greater	3/4 inch or 1 inch

Aggregate gradation must be within the TV limits for the specified sieve size shown in the following tables:

**Aggregate Gradations for Type A HMA
(Percentage Passing)**

1 inch

Sieve size	Target value limit	Allowable tolerance
1"	100	--
3/4"	88–93	TV ± 5
1/2"	72–85	TV ± 6
3/8"	55–70	TV ± 6
No. 4	35–52	TV ± 7
No. 8	22–40	TV ± 5
No. 30	8–24	TV ± 4
No. 50	5–18	TV ± 4
No. 200	3.0–7.0	TV ± 2.0

3/4 inch

Sieve size	Target value limit	Allowable tolerance
1"	100	--
3/4"	90–98	TV ± 5
1/2"	70–90	TV ± 6
No. 4	42–58	TV ± 5
No. 8	29–43	TV ± 5
No. 30	10–23	TV ± 4
No. 200	2.0–7.0	TV ± 2.0

1/2 inch

Sieve size	Target value limit	Allowable tolerance
3/4"	100	--
1/2"	95–98	TV ± 5
3/8"	72–95	TV ± 5
No. 4	52–69	TV ± 5
No. 8	35–55	TV ± 5
No. 30	15–30	TV ± 4
No. 200	2.0–8.0	TV ± 2.0

3/8 inch

Sieve size	Target value limit	Allowable tolerance
1/2"	100	--
3/8"	95–98	TV ± 5
No. 4	55–75	TV ± 5
No. 8	30–50	TV ± 5
No. 30	15–35	TV ± 5
No. 200	2.0–9.0	TV ± 2.0

No. 4

Sieve size	Target value limit	Allowable tolerance
3/8"	100	--
No. 4	95–98	TV ± 5
No. 8	70–80	TV ± 6
No. 30	34–45	TV ± 5
No. 200	2.0–12.0	TV ± 4.0

39-2.02B(5) Reclaimed Asphalt Pavement

You may substitute RAP for part of the virgin aggregate in a quantity up to 15 percent of the aggregate blend.

Provide enough space at your plant for complying with all RAP handling requirements. Provide a clean, graded base, well drained area for stockpiles.

If RAP is from multiple sources, blend the RAP thoroughly and completely before fractionating.

For RAP substitution of 15 percent of the aggregate blend or less, fractionation is not required.

Isolate the processed RAP stockpiles from other materials. Store processed RAP in conical or longitudinal stockpiles. Processed RAP must not be agglomerated or be allowed to congeal in large stockpiles.

39-2.02B(6)–39-2.02B(10) Reserved

39-2.02B(11) Type A Hot Mix Asphalt Production

If RAP is used, the asphalt plant must automatically adjust the virgin asphalt binder to account for RAP percentage and RAP binder.

During production, you may adjust hot- or cold-feed proportion controls for virgin aggregate and RAP. RAP must be within ± 3 of RAP percentage described in your Contractor Job Mix Formula Proposal form without exceeding 15 percent.

39-2.02C Construction

Place Type A HMA in lifts as shown in the project details.

Where the pavement thickness shown is greater than 0.30 foot, you may place Type A HMA in multiple lifts not less than 0.15 foot each. If placing Type A HMA in multiple lifts:

1. Aggregate gradation must comply with the requirements shown in the following table:

Type A HMA lift thickness	Gradation
0.15 to less than 0.20 foot	1/2 inch
0.20 foot to less than 0.25 foot	3/4 inch
0.25 foot or greater	3/4 inch or 1 inch

2. Apply a tack coat before placing a subsequent lift
3. The Engineer evaluates each HMA lift individually for compliance

If the ambient air temperature is below 60 degrees F, cover the loads in trucks with tarpaulins. If the time for HMA discharge to truck at the HMA plant until transfer to paver's hopper is 90 minutes or greater and if the ambient air temperature is below 70 degrees F, cover the loads in trucks with tarpaulins, unless the time from discharging to the truck until transfer to the paver's hopper or the pavement surface is less than 30 minutes. The tarpaulins must completely cover the exposed load until you transfer the mixture to the paver's hopper or the pavement surface.

Spread Type A HMA at the ambient air and surface temperatures shown in the following table:

Minimum Ambient Air and Surface Temperatures

Lift thickness (feet)	Ambient air (°F)		Surface (°F)	
	Unmodified asphalt binder	Modified asphalt binder	Unmodified asphalt binder	Modified asphalt binder
Type A HMA and Type A HMA produced with WMA water injection technology				
<0.15	55	50	60	55
≥0.15	45	45	50	50
Type A HMA produced with WMA additive technology				
<0.15	45	45	50	45
≥0.15	40	40	40	40

For Type A HMA and Type A HMA produced with WMA water injection technology placed under method compaction, if the asphalt binder is:

1. Unmodified, complete:
 - 1.1. 1st coverage of breakdown compaction before the surface temperature drops below 250 degrees F
 - 1.2. Breakdown and intermediate compaction before the surface temperature drops below 190 degrees F
 - 1.3. Finish compaction before the surface temperature drops below 150 degrees F
2. Modified, complete:
 - 2.1. 1st coverage of breakdown compaction before the surface temperature drops below 240 degrees F
 - 2.2. Breakdown and intermediate compaction before the surface temperature drops below 180 degrees F
 - 2.3. Finish compaction before the surface temperature drops below 140 degrees F

For Type A HMA produced with WMA additive technology placed under method compaction, if the asphalt binder is:

1. Unmodified, complete:
 - 1.1 1st coverage of breakdown compaction before the surface temperature drops below 240 degrees F
 - 1.2. Breakdown and intermediate compaction before the surface temperature drops below 190 degrees F
 - 1.3. Finish compaction before the surface temperature drops below 140 degrees F
 - 1.4 You may continue static rolling below 140 degrees F to remove roller marks.
2. Modified, complete:
 - 2.1. 1st coverage of breakdown compaction before the surface temperature drops below 230 degrees F
 - 2.2. Breakdown and intermediate compaction before the surface temperature drops below 170 degrees F
 - 2.3. Finish compaction before the surface temperature drops below 130 degrees F
 - 2.4. You may continue static rolling below 130 degrees F to remove roller marks.

You may cool Type A HMA with water when rolling activities are complete if authorized.

39-2.02D Payment

Not Used

39-2.07 MINOR HOT MIX ASPHALT

39-2.07A General

39-2.07A(1) Summary

Section 39-2.07 includes specifications for producing and placing minor hot mix asphalt.

Minor HMA must comply with section 39-2.02 except as specified in this section 39-2.07.

The inertial profiler requirements in section 36-3 do not apply.

39-2.07A(2) Definitions

Reserved

39-2.07A(3) Submittals

The QC plan and test results in sections 39-2.01A(3)(c) and 39-2.01A(3)(d) do not apply.

39-2.07A(4) Quality Assurance

39-2.07A(4)(a) General

The JMF renewal requirements in section 39-2.01A(4)(d) do not apply.

Test pavement smoothness with a 12 foot straightedge.

39-2.07A(4)(b) Quality Control

Testing for compliance with the following quality characteristics is not required:

1. Flat and elongated particles
2. Fine aggregate angularity
3. Hamburg wheel track
4. Moisture susceptibility

39-2.07A(4)(c) Department Acceptance

The Department accepts minor HMA under section 39-2.02A(4)(e) except for compliance with requirements for the following quality characteristics:

1. Flat and elongated particles
2. Fine aggregate angularity
3. Hamburg wheel track
4. Moisture susceptibility

39-2.07B Materials

39-2.07B(1) General

Reserved

39-2.07B(2) Minor Hot Mix Asphalt Mix Design

The Hamburg wheel track and moisture susceptibility requirements do not apply to the mix design for minor HMA.

39-2.07B(3) Asphalt Binder

The grade of asphalt binder for minor HMA must be PG-64-10 or PG-64-16.

39-2.07B(4) Liquid Antistrip Treatment

Treat minor HMA with liquid antistrip unless you submit AASHTO T 283 and AASHTO T 324 (Modified) test results showing compliance with section 39-2.02B and dated within 12 months of the submittal.

39-2.07C Construction

Not Used

39-2.07D Payment

Not Used

39-2.08–39-2.10 RESERVED**39-3 EXISTING ASPHALT CONCRETE****39-3.01 GENERAL****39-3.01A General**

Section 39-3.01 includes general specifications for performing work on existing asphalt concrete facilities.

Work performed on existing asphalt concrete facilities must comply with section 15.

39-3.01B Materials

Not Used

39-3.01C Construction

Before removing a portion of an asphalt concrete facility, make a 2-inch deep saw cut to a true line along the limits of the removal area.

39-3.01D Payment

Not Used

39-3.02 REPLACE ASPHALT CONCRETE SURFACING**39-3.02A General**

Section 39-3.02 includes specifications for replacing asphalt concrete surfacing.

39-3.02B Materials

HMA to be used for replacing asphalt concrete surfacing must comply with Type A HMA as specified in section 39-2.02.

The grade of asphalt binder must be PG 64-10 or PG 64-16.

Tack coat must comply with section 39-2.01B(10).

39-3.02C Construction

Where replace asphalt concrete surfacing is shown, remove the asphalt concrete surfacing and, if necessary, base to a depth of 6 inches below the grade of the existing surfacing and replace with HMA. The Engineer determines the exact limits of asphalt concrete surfacing to be replaced.

The width of each removal shall be a minimum of four feet wide or as determined by the Engineer

Use cold planned material for shoulder backing inside the project limits, as per these specifications and as directed by the Engineer.

Replace asphalt concrete in a lane before the lane is specified to be opened to traffic.

Before removing asphalt concrete, outline the replacement area and cut neat lines with a saw or grind to a depth of 6 inches below the grade of the existing surfacing. Do not damage any asphalt concrete and base remaining in place.

If you excavate the base beyond the specified plane, replace it with HMA.

Do not use a material transfer vehicle for replacing asphalt concrete surfacing.

Before placing HMA, apply a tack coat as specified in section 39-2.01C(3)(f).

Place HMA using method compaction as specified in section 39-2.01C(2)(c).

The contract price paid per square feet for Remove Asphalt Concrete Pavement shall include full compensation for furnishing all labor, materials, tools, equipment, and incidentals, and for doing all work

involved in repairing pavement, complete in place, including disposal of removed material, as specified in the Standard Specifications and these special provisions, and as directed by the Engineer.

The quantity of Remove Asphalt Concrete Pavement to be paid for will be the actual area repaired.

39-3.02D Payment

The payment quantity for replace asphalt concrete surfacing is the volume determined from the dimensions shown.

39-3.03 REMOVE ASPHALT CONCRETE DIKES & BERMS

39-3.03A General

Section 39-3.03 applies to removing asphalt concrete dikes and berms outside the limits of excavation.

39-3.03B Materials

Not Used

39-3.03C Construction

Reserved

39-3.03D Payment

Not Used

39-3.04 COLD PLANING ASPHALT CONCRETE PAVEMENT

39-3.04A General

Section 39-3.04 includes specifications for cold planing asphalt concrete pavement.

Cold planing asphalt concrete pavement includes the removal of pavement markers, traffic stripes, and pavement markings within the area of cold planing.

Schedule cold planing activities such that the pavement is cold planed, the HMA is placed, and the area is opened to traffic during the same work shift.

39-3.04B Materials

HMA for temporary tapers must be of the same quality that is used for the HMA overlay or comply with the specifications for minor HMA in section 39-2.07.

39-3.04C Construction

39-3.04C(1) General

Do not use a heating device to soften the pavement.

The cold planing machine must be:

1. Equipped with a cutter head width that matches the planing width unless a wider cutter head is authorized.
2. Equipped with automatic controls for the longitudinal grade and transverse slope of the cutter head and:
 - 2.1. If a ski device is used, it must be at least 30 feet long, rigid, and a 1-piece unit. The entire length must be used in activating the sensor.
 - 2.2. If referencing from existing pavement, the cold planing machine must be controlled by a self-contained grade reference system. The system must be used at or near the centerline of the roadway. On the adjacent pass with the cold planing machine, a joint-matching shoe may be used.
3. Equipped to effectively control dust generated by the planing operation
4. Operated such that no fumes or smoke is produced.

Replace broken, missing, or worn machine teeth.

If you do not complete placing the HMA surfacing before opening the area to traffic, you must:

1. Construct a temporary HMA taper to the level of the existing pavement.
2. Place HMA during the next work shift.
3. Submit a corrective action plan that shows you will complete cold planing and placement of HMA in the same work shift. Do not restart cold planing activities until the corrective action plan is authorized.

39-3.04C(2) Grade Control and Surface Smoothness

Install and maintain grade and transverse slope references.

The final cut must result in a neat and uniform surface.

The completed surface of the planed pavement must not vary more than 0.02 foot when measured with a 12-foot straightedge parallel with the centerline. With the straightedge at right angles to the centerline, the transverse slope of the planed surface must not vary more than 0.03 foot.

Where lanes are open to traffic, the drop-off of between adjacent lanes must not be more than 0.15 foot.

39-3.04C(3) Planed Material

Remove cold planed material concurrently with planing activities such that the removal does not lag more than 50 feet behind the planer.

39-3.04C(4) Temporary HMA Tapers

If a drop-off between the existing pavement and the planed area at transverse joints cannot be avoided before opening to traffic, construct a temporary HMA taper.

Compact by any method that will produce a smooth riding surface

Completely remove temporary tapers before placing permanent surfacing.

39-3.04D Payment

Not Used

39-3.05 REMOVE BASE AND SURFACING

39-3.05A General

Section 39-3.05 includes specifications for removing base and asphalt concrete surfacing.

39-3.05B Materials

Not Used

39-3.05C Construction

Where base and surfacing are described to be removed, remove base and surfacing to a depth of at least 6 inches below the grade of the existing surfacing. Backfill resulting holes and depressions with embankment material under section 19.

39-3.05D Payment

The payment quantity for remove base and surfacing is the volume determined from the dimensions shown.

39-3.06–39-3.08 RESERVED

DIVISION VIII MISCELLANEOUS CONSTRUCTION

78 INCIDENTAL CONSTRUCTION

Add the Following to Section 78-2

Damaged or destroyed survey monuments shall be replaced with new survey monuments.

Survey monuments shall be constructed or adjusted, as applicable, in accordance with Standard Drawing A-74 Type D.

Survey control for the reestablishment of survey monuments will be provided by the Department.

DIVISION IX TRAFFIC CONTROL DEVICES
81 MISCELLANEOUS TRAFFIC CONTROL DEVICES

Add to Section 81-8.03B:

Remove existing pavement markers and any bituminous or epoxy adhesives, prior to placing chip seal. Install pavement markers.

Dispose of all removed materials.

Replace Section 81-8.04 with:

Removal of existing pavement markers and any bituminous or epoxy adhesives, and disposal of all removed materials is paid under Remove Pavement Marker.

82 SIGNS AND MARKERS

Replace Section 82-1.01A with:

82-1.01A Summary

Section 82-1 includes general specifications for fabricating and installing sign panels and markers and constructing roadside signs.

Signs and markers must comply with the *California MUTCD*, *California Sign Specifications*, and the FHWA publication *Standard Highway Signs and Markings*. For the *California Sign Specifications*, go to the Caltrans Traffic Operations website.

Replace Item 1 of the 2nd paragraph of section 82-2.02A with:

1. Phrase *Property of The County of Fresno*

Add to section 82-2.02B:

Signs must be 0.080 inch thick aluminum alloy and street name signs must be 0.125 inch thick alloy faced on both sides.

Add to section 82-2.02C:

Reflective sheeting on all signs shall be 3M Diamond Grade DG3 Series 4000 or equal and must meet ASTM Type XI specifications.

Add to section 82-2.02D:

All signs must have the 3M 1160 graffiti resistant clear overlay film or equal.

Replace Section 82-2.04 with:

82-2.04 PAYMENT

Not Used

Add to section 82-3.02A:

All new roadside signs must be square post 14 gauge steel.

Add to section 82-3.02B:

All post for traffic signs must be 2"X2"X10' square by 14 gauge steel, with 7/16 inch holes punched one inch on center on all four sides for the entire length of the post.

Welded Anchor (2 ¼"X2 ¼"X30") and sleeve (2 ½"X2 ½"X18") shall be used as a base to anchor post in the ground. Hole size and placement must be the same as the metal post.

All mounting hardware shall be either galvanized or stainless steel. Banding shall be 3/4 inch wide stainless steel with flare leg sign brackets. Hose clamps are not permitted. All signs shall be mounted using 3/8" aluminum drive rivets. Nuts and bolts are not permitted.

Replace Section 82-3.02D with:

82-3.02D Laminated Wood Box Posts

Furnish a laminated wood box post with an attached metal cap at the top of each post.

Replace the last line of section 82-3.04 with:

Full compensation for furnishing sign panels is included in the bid item price per each Roadside Sign - One Post and Roadside Sign - Two Post. One or more sign panels furnished and installed on a single post will be counted as (1) one Roadside Sign - One Post. One or more sign panels furnished and installed on two posts will be counted as (1) one Roadside Sign - Two Post.

84 MARKINGS

Add to Section 84-1.03

Before obliterating any pavement delineation (traffic stripes, pavement markings) that is to be replaced on the same alignment and location, as determined by the Engineer, the pavement delineation shall be referenced by the Contractor, with a sufficient number of control points to reestablish the alignment and location of the new pavement delineation. The references shall include the limits or changes in striping pattern, including one- and 2-way barrier lines, limit lines, crosswalks and other pavement markings. Full compensation for referencing existing pavement delineation shall be considered as included in the contract prices paid for various items of work and no additional compensation will be allowed.

The Contractor shall protect pedestrian crosswalks, stop bars, rumble bars, and rumble Botts' dots from damage or displacement, unless otherwise directed by the Engineer.

Replace or repair facilities, which are damaged with your operation, at your expense.

Add between the 1st and 2nd paragraphs of section 84-2.01C:

For each lot or batch of thermoplastic, submit a manufacturer's certificate of compliance with test results for the tests specified in section 84-2.01D. The date of test must be within 1 year of use.

Add to the end of section 84-2.01D:

Each lot or batch of thermoplastic must be tested under California Test 423 for:

1. Brookfield Thermosel viscosity
2. Hardness
3. Yellowness index, white only
4. Daytime luminance factor
5. Yellow color, yellow only
6. Glass bead content
7. Binder content

During the installation of thermoplastic traffic stripes or markings at the job site, apply a test stripe of the thermoplastic on suitable material in the presence of the Engineer. The test stripe must be at least 1 foot in length. The test stripe will be tested for yellow color, daytime luminance factor, and yellowness index requirements.

Delete the 1st paragraph of Section 84-2.03C(2)(a)

Replace the 2nd paragraph of section 84-2.03C(2)(b) with:

Apply extruded thermoplastic for a traffic stripe at a rate of at least 0.37 lb of thermoplastic per foot of 4-inch-wide solid stripe. The applied thermoplastic traffic stripe must be at least 0.100 inch thick.

Replace Section 84-2.03C(2)(c) with:

Apply sprayable thermoplastic under State Specification PTH-02SPRAY at a temperature from 350 to 400 degrees F.

Apply sprayable thermoplastic at a rate of at least 0.22 lb of thermoplastic per foot of 4-inch-wide solid stripe.

The applied sprayable thermoplastic material must be 0.08 inch (80 mil) thick, and shall be visible from both directions of travel

DIVISION XI MATERIALS

92 ASPHALT BINDERS

Replace 92-1.01D(2) with:

92-1.01D(2) Certification

Asphalt binder suppliers must comply with the Caltrans Certification Program for Suppliers of Asphalt. For a copy of the certification program, go to the METS website.

Replace Section 92-1.02B with

92-1.02B Performance Grade Asphalt Binders

PG asphalt binder must comply with the requirements shown in the following table:

PG Asphalt Binders

Quality characteristic	Test method	Requirement				
		PG 58-22 ^a	PG 64-10	PG 64-16	PG 64-28	PG 70-10
Original Binder						
Flash point (min, °C)	AASHTO T 48	230	230	230	230	230
Solubility ^b (min, %)	AASHTO T 44	99	99	99	99	99
Viscosity at 135 °C ^c (max, Pa•s)	AASHTO T 316	3.0	3.0	3.0	3.0	3.0
Dynamic shear Test temperature at 10 rad/s (°C) G*/sin(delta) (min, kPa) G*/sin(delta) (max, kPa)	AASHTO T 315	58 1.00 2.00	64 1.00 2.00	64 1.00 2.00	64 1.00 2.00	70 1.00 2.00
RTFO ^f test ^e mass loss (max, %)	AASHTO T 240	1.00	1.00	1.00	1.00	1.00
RTFO ^f Test Aged Binder						
Dynamic shear Test temperature at 10 rad/s (°C) G*/sin(delta) (min, kPa)	AASHTO T 315	58 2.20	64 2.20	64 2.20	64 2.20	70 2.20
Ductility at 25 °C (min, cm)	AASHTO T 51	75	75	75	75	75
PAV ^g Test temperature (°C)	AASHTO R 28	100	100	100	100	110
RTFO ^f Test and PAV ^g Aged Binder						
Dynamic shear, Test temperature at 10 rad/s (°C) G*/sin(delta) (max, kPa)	AASHTO T 315	22 ^d 5000	31 ^d 5000	28 ^d 5000	22 ^d 5000	34 ^d 5000
Creep stiffness, Test temperature, °C S-value (max, MPa) M-value (min)	AASHTO T 313	-12 300 0.300	0 300 0.300	-6 300 0.300	-18 300 0.300	0 300 0.300

^aUse as asphalt rubber base stock for high mountain and high desert area.

^bThe Engineer waives solubility requirements if the supplier is an authorized material source as defined by the Caltrans *Certification Program for Suppliers of Asphalt*.

^cThe Engineer waives this specification if the supplier provides written certification the asphalt binder can be adequately pumped and mixed at temperatures meeting applicable safety standards.

^dTest the sample at 3 °C higher if it fails at the specified test temperature. G*/sin(delta) remains 5000 kPa maximum.

^eThe residue from mass change determination may be used for other tests.

^fRTFO means rolling thin film oven.

^gPAV means Pressure Aging Vessel.

PG modified asphalt binder must comply with the requirements shown in the following table:

PG Modified Asphalt Binders

Quality characteristic	Test method	Requirement		
		PG 58-34 M	PG 64-28 M	PG 76-22 M
Original Binder				
Flash point (min, °C)	AASHTO T 48	230	230	230
Solubility (min, %)	AASHTO T 44 ^a	97.5	97.5	97.5 ^b
Viscosity at 135 °C ^c (max, Pa·s)	AASHTO T 316	3.0	3.0	3.0
Dynamic shear, Test temperature at 10 rad/s (°C) G*/sin(delta) (min, kPa)	AASHTO T 315	58 1.00	64 1.00	76 1.00
RTFO ^g test ^d , Mass loss (max, %)	AASHTO T 240	1.00	1.00	1.00
RTFO ^g Test Aged Binder				
Dynamic shear, Test temperature at 10 rad/s (°C) G*/sin(delta) (min, kPa)	AASHTO T 315	58 2.20	64 2.20	76 2.20
Dynamic shear, Test temperature at 10 rad/s, °C Delta (max, degree)	AASHTO T 315	80 ^e	80 ^e	80 ^e
Elastic recovery ^f , Test temperature (°C) Recovery (min, %)	AASHTO T 301	25 75	25 75	25 65
PAV ^h , Temperature (°C)	AASHTO R 28	100	100	110
RTFO ^g Test and PAV ^h Aged Binder				
Dynamic shear, Test temperature at 10 rad/s (°C) G*/sin(delta) (max, kPa)	AASHTO T 315	16 5000	22 5000	31 5000
Creep stiffness, Test temperature (°C) S-value (max, Mpa) M-value (min)	AASHTO T 313	-24 300 0.300	-18 300 0.300	-12 300 0.300

^aThe Department allows ASTM D5546 or ASTM D7553 instead of AASHTO T 44. Particles recovered from ASTM D5546 or ASTM D7553 or AASHTO T 44 must be less than 250 µm.

^bReport only for spray application.

^cThe Engineer waives the viscosity requirements if the supplier provides written certification the asphalt binder can be adequately pumped and mixed at temperatures meeting applicable safety standards.

^dThe residue from mass change determination may be used for other tests.

^eTest temperature is the temperature at which G*/sin(delta) is 2.2 kPa. A graph of log G*/sin(delta) plotted against temperature may be used to determine the test temperature when G*/sin(delta) is 2.2 kPa. A graph of (delta) versus temperature may be used to determine delta at the temperature when G*/sin(delta) is 2.2 kPa. The graph must have at least 2 points that envelope G*/sin(delta) of 2.2 kPa, and the test temperature must not be more than 6 degree C apart. The Engineer also accepts direct measurement of delta at the temperature when G*/sin(delta) is 2.2 kPa.

^fTests without a force ductility clamp may be performed.

^gRTFO means rolling thin film oven.

^hPAV means Pressure Aging Vessel.

Do not modify PG modified asphalt binder using polyphosphoric acid.

Crumb rubber must be from automobile and truck tires and must be free from contaminants including fabric, metal, minerals, and other nonrubber substances.

PG modified asphalt binder modified with crumb rubber must be homogeneous and must not contain visible particles of crumb rubber.

The supplier of PG modified asphalt binder modified with crumb rubber must:

1. Report the quantity of crumb rubber by weight of asphalt binder
2. Certify a minimum of 10 percent of crumb rubber by weight of asphalt binder

94 ASPHALTIC EMULSIONS

Replace the 1st sentence in Section 94-1.01D with:

Sample asphaltic emulsion under AASHTO R66.

Project Details

DEPARTMENT OF PUBLIC WORKS AND PLANNING
 2020 / 2021 BITUMINOUS SEAL COATS
 CONTRACT NO. 20-14-M

BASE BID (LOCATIONS 1 TO 12)

NO.	PROJECT LOCATION	LIMITS		LENGTH (miles)	CHIPPED AREA (SY)		PMCRS-2h EMULSION (tons)	3/8" SCREENING (tons)	FOG SEAL EMULSION (tons)		SAND (tons)	
					TRAVEL LANE	LT/ACC/DEC LANE & MEDIAN			CHIPPED AREA	SHOULDER/ BIKE LANE	TRAVEL LANE	SHOULDER/ BIKE LANE
		FROM	TO									
1	COALINGA-MENDOTA	DERRICK	2.500 SE/O DERRICK	2.500	35,200		50.0	462.0	10.0	1.0	111.0	7.0
2	DICKENSON	SHIELDS	HERNDON	3.647	51,350		72.0	674.0	14.0		162.0	
3	HENDERSON RD	ORMUS	ONTARIO	5.524	77,778		109.0	1,021.0	21.0	7.0	246.0	82.0
4	ORMUS	MANNING	HENDERSON RD	0.144	2,028		3.0	27.0	1.0	1.0	7.0	1.0
5	MOUNTAIN VIEW	SSR 41	MARKS	3.270	46,042	1,700	67.0	627.0	13.0	5.0	146.0	49.0
6	SAND CREEK RD	COUNTY LINE (TULARE)	ENNIS	2.035	28,653		41.0	377.0	8.0		91.0	
7	NEES	JERROLD	FAIRFAX	2.005	28,231		40.0	371.0	8.0	5.0	89.0	60.0
8	AUBERRY RD	2.652 NE/O DRY CREEK	MILLERTON RD (EAST)	1.653	23,275	3,465	38.0	351.0	7.0	3.0	74.0	25.0
9	JEFFERSON	CALAVERAS	SAN MATEO	1.997	28,118		40.0	370.0	8.0	3.0	89.0	30.0
10	MCKINLEY	MCCALL	NEWMARK	4.506	63,445		89.0	833.0	17.0		200.0	
11	ENNIS	GEORGE SMITH	SAND CREEK	0.769	10,828		16.0	143.0	3.0	1.0	35.0	7.0
12	PEPPERWEED RD	SAND CREEK RD	SQUAW VALLEY RD	1.568	22,078		31.0	290.0	6.0		70.0	
BASE BID TOTALS				29.618	394,948	5,165	565.0	5,256.0	142.0		1,581.0	

NOTES:

1. THE EXISTING CONCRETE BRIDGE SURFACE SHALL BE KEPT AS IS (LOCATION 10, FRESNO CANAL BRIDGE).
2. CHIP THE EXISTING LEFT-TURN (LT) LANES AND ON-GRADE MEDIAN AREAS AT LOCATION 5 (MOUNTAIN VIEW).
3. CHIP THE EXISTING LEFT-TURN (LT), ACCELERATION (ACC), DECELERATION (DEC) LANES, AND ON-GRADE MEDIAN AREAS AT LOCATION 8 (AUBERRY).

DEPARTMENT OF PUBLIC WORKS AND PLANNING
 2020 / 2021 BITUMINOUS SEAL COATS
 CONTRACT NO. 20-14-M

TRAFFIC STRIPING AND PAVEMENT MARKING DETAILS

BASE BID (LOCATIONS 1 TO 12)

NO.	LOCATION	LIMITS		LENGTH		STRIPING															
						DETAIL	DETAIL	DETAIL	DETAIL	DETAIL	DETAIL	DETAIL	DETAIL	DETAIL	DETAIL	DETAIL	DETAIL	DETAIL	DETAIL	DETAIL	DETAIL
						1	5	6	15	18	19	21	22	27B	28	29	38	38A	39	39A	
		FROM	TO	(MILES)	(FEET)	(LF)	(LF)	(LF)	(LF)	(LF)	(LF)	(LF)	(LF)	(LF)	(LF)	(LF)	(LF)	(LF)	(LF)	(LF)	
1	COALINGA-MENDOTA	DERRICK	2.500 SE/O DERRICK	2.500	13,200		13,200														
2	DICKENSON	SHIELDS	HERNDON	3.647	19,256		16,256			3,000											
3	HENDERSON RD	ORMUS	ONTARIO	5.524	29,166	320	19,916		410	3,900		4,130	490	58,332							
4	ORMUS	MANNING	HENDERSON RD	0.144	760							760		1,520							
5	MOUNTAIN VIEW	SSR 41	MARKS	3.270	17,265		10,117			3,608		3,540		34,530	1,743				530		
6	SAND CREEK RD	COUNTY LINE (TULARE)	ENNIS	2.035	10,744								10,744	15,000							
7	NEES	JERROLD	FAIRFAX	2.005	10,586			9,966			620			21,172							
8	AUBERRY RD	2.652 NE/O DRY CREEK	MILLERTON RD (EAST)	1.653	8,727								7,600			2,350	1,100			16,850 ^(P)	700 ^(P)
9	JEFFERSON	CALAVERAS	SAN MATEO	1.997	10,544		9,944			600				21,088							
10	MC KINLEY	MC CALL	NEWMARK	4.506	23,791		19,891			3,900											
11	ENNIS	GEORGE SMITH	SAND CREEK	0.769	4,060							4,060									
12	PEPPERWEED RD	SAND CREEK RD	SQUAW VALLEY RD	1.568	8,279								8,279	16,558							
BASE BID TOTALS				29.618	156,378	320	89,324	9,966	410	15,008	620	12,490	27,113	168,200	1,743	2,350	1,100	530	16,850	700	

^(P) WATERBORNE PAINT

BASE BID (LOCATIONS 1 TO 12)

NO.	LOCATION	LIMITS		LENGTH		RPM			PAVEMENT MARKING													
						TYPE D	TYPE H	BOTTS' DOT	STOP BAR	"STOP AHEAD"	ARROW TYPE I	TURN ARROW	BIKELANE SYMBOL WITH ARROW	"STOP"								
						(EA)	(EA)	(EA)	(SF)	(SF)	(SF)	(SF)	(SF)	(SF)								
		FROM	TO	(MILES)	(FEET)																	
1	COALINGA-MENDOTA	DERRICK	2.500 SE/O DERRICK	2.500	13,200																	
2	DICKENSON	SHIELDS	HERNDON	3.647	19,256			180	60	265												
3	HENDERSON RD	ORMUS	ONTARIO	5.524	29,166	43																
4	ORMUS	MANNING	HENDERSON RD	0.144	760				12	53												
5	MOUNTAIN VIEW	SSR 41	MARKS	3.270	17,265				64	212		90										
6	SAND CREEK RD	COUNTY LINE (TULARE)	ENNIS	2.035	10,744	940																
7	NEES	JERROLD	FAIRFAX	2.005	10,586	232	27															
8	AUBERRY RD	2.652 NE/O DRY CREEK	MILLERTON RD (EAST)	1.653	8,727	768					56	105	126 ^(P)									
9	JEFFERSON	CALAVERAS	SAN MATEO	1.997	10,544																	
10	MC KINLEY	MC CALL	NEWMARK	4.506	23,791				65	159												
11	ENNIS	GEORGE SMITH	SAND CREEK	0.769	4,060				24	159												
12	PEPPERWEED RD	SAND CREEK RD	SQUAW VALLEY RD	1.568	8,279	724			15	53												
BASE BID TOTALS				29.618	156,378	2,706	27	180	240	901	56	195	126									

^(P) WATERBORNE PAINT

- NOTES: 1. ALL TRAFFIC STRIPES TO BE SPRAYABLE THERMOPLASTIC EXCEPT WHERE NOTED WITH ^(P)
 2. PAVEMENT MARKINGS TO BE THERMOPLASTIC EXCEPT WHERE NOTED WITH ^(P)
 3. ABBREVIATION: RPM - RAISED PAVEMENT MARKER

DEPARTMENT OF PUBLIC WORKS AND PLANNING
 2020 / 2021 BITUMINOUS SEAL COATS
 CONTRACT NO. 20-14-M

TRAFFIC STRIPING AND PAVEMENT MARKING REMOVAL DETAILS

BASE BID (LOCATIONS 1 TO 12)

NO.	LOCATION	LIMITS		LENGTH		STRIPING										RPM			PAVEMENT MARKING				
						DETAIL	DETAIL	DETAIL	DETAIL	DETAIL	DETAIL	DETAIL	DETAIL	DETAIL	DETAIL	TYPE	TYPE	BOTTS'	STOP	TURN	ARROW	"STOP"	
						1	6	15	19	21	22	27B	29	38	38A	D	H	DOT	BAR	ARROW	TYPE I	"AHEAD"	
		FROM	TO	(MILES)	(FEET)	(LF)	(LF)	(LF)	(LF)	(LF)	(LF)	(LF)	(LF)	(LF)	(LF)	(EA)	(EA)	(EA)	(SF)	(SF)	(SF)	(SF)	
1	COALINGA-MENDOTA	DERRICK	2.500 SE/O DERRICK	2.500	13,200																		
2	DICKENSON	SHIELDS	HERNDON	3.647	19,256												180						106
3	HENDERSON RD	ORMUS	ONTARIO	5.524	29,166	320		410			490					43							
4	ORMUS	MANNING	HENDERSON RD	0.144	760																		
5	MOUNTAIN VIEW	SSR 41	MARKS	3.270	17,265																		
6	SAND CREEK RD	COUNTY LINE (TULARE)	ENNIS	2.035	10,744					10,744	15,000					940							
7	NEES	JERROLD	FAIRFAX	2.005	10,586											232	27						
8	AUBERRY RD	2.652 NE/O DRY CREEK	MILLERTON RD (EAST)	1.653	8,727					7,600		2,350	1,100			768				105	56		
9	JEFFERSON	CALAVERAS	SAN MATEO	1.997	10,544																		
10	MC KINLEY	MC CALL	NEWMARK	4.506	23,791																		
11	ENNIS	GEORGE SMITH	SAND CREEK	0.769	4,060				2,100														
12	PEPPERWEED RD	SAND CREEK RD	SQUAW VALLEY RD	1.568	8,279					8,279	16,558					724				15			53
BASE BID TOTALS				29.618	156,378	320		410		2,100	27,113	31,558	2,350	1,100		2,706	27	180	15	105	56	159	

NOTES: 1. THE EXISTING PAINT STRIPES AND PAINT PAVEMENT MARKINGS SHALL NOT BE REMOVED

LOCATION MAP

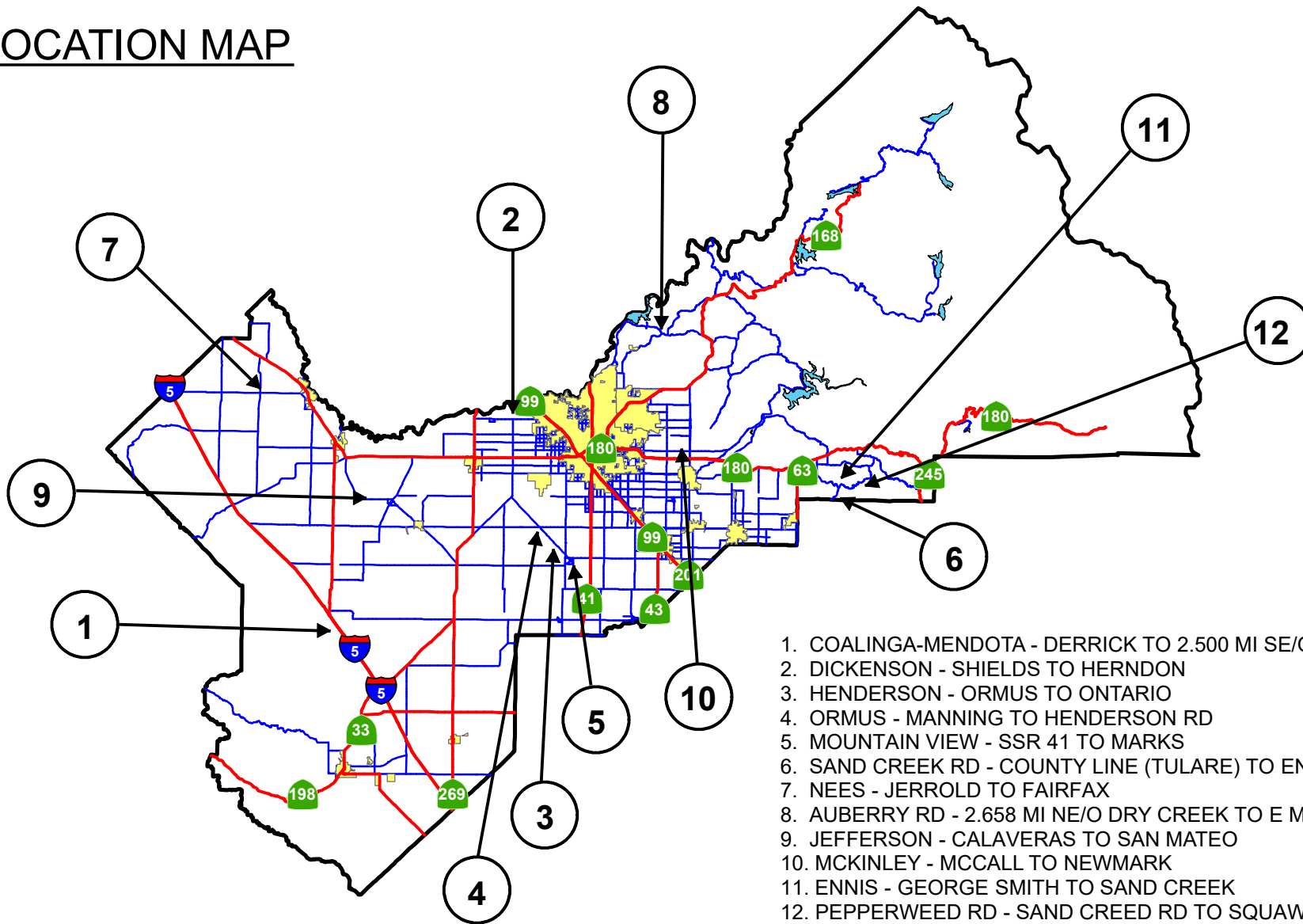

1. COALINGA-MENDOTA - DERRICK TO 2.500 MI SE/O DERRICK
2. DICKENSON - SHIELDS TO HERNDON
3. HENDERSON - ORMUS TO ONTARIO
4. ORMUS - MANNING TO HENDERSON RD
5. MOUNTAIN VIEW - SSR 41 TO MARKS
6. SAND CREEK RD - COUNTY LINE (TULARE) TO ENNIS
7. NEES - JERROLD TO FAIRFAX
8. AUBERRY RD - 2.658 MI NE/O DRY CREEK TO E MILLERTON RD
9. JEFFERSON - CALAVERAS TO SAN MATEO
10. MCKINLEY - MCCALL TO NEWMARK
11. ENNIS - GEORGE SMITH TO SAND CREEK
12. PEPPERWEED RD - SAND CREED RD TO SQUAW VALLEY RD

CONTRACT NUMBER: 20-14-M

DATE:

NO SCALE

DEPARTMENT OF PUBLIC WORKS & PLANNING

DESIGNED: C.M. 12/02/2020

DRAWN: C.M. 12/02/2020

PROJECT NO. L 499058



2020-2021 BITUMINOUS SEAL COATS
VARIOUS LOCATIONS IN FRESNO COUNTY

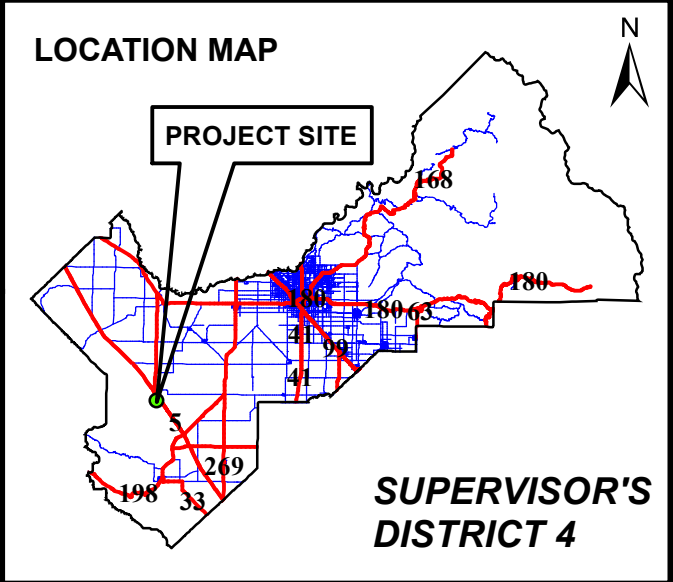
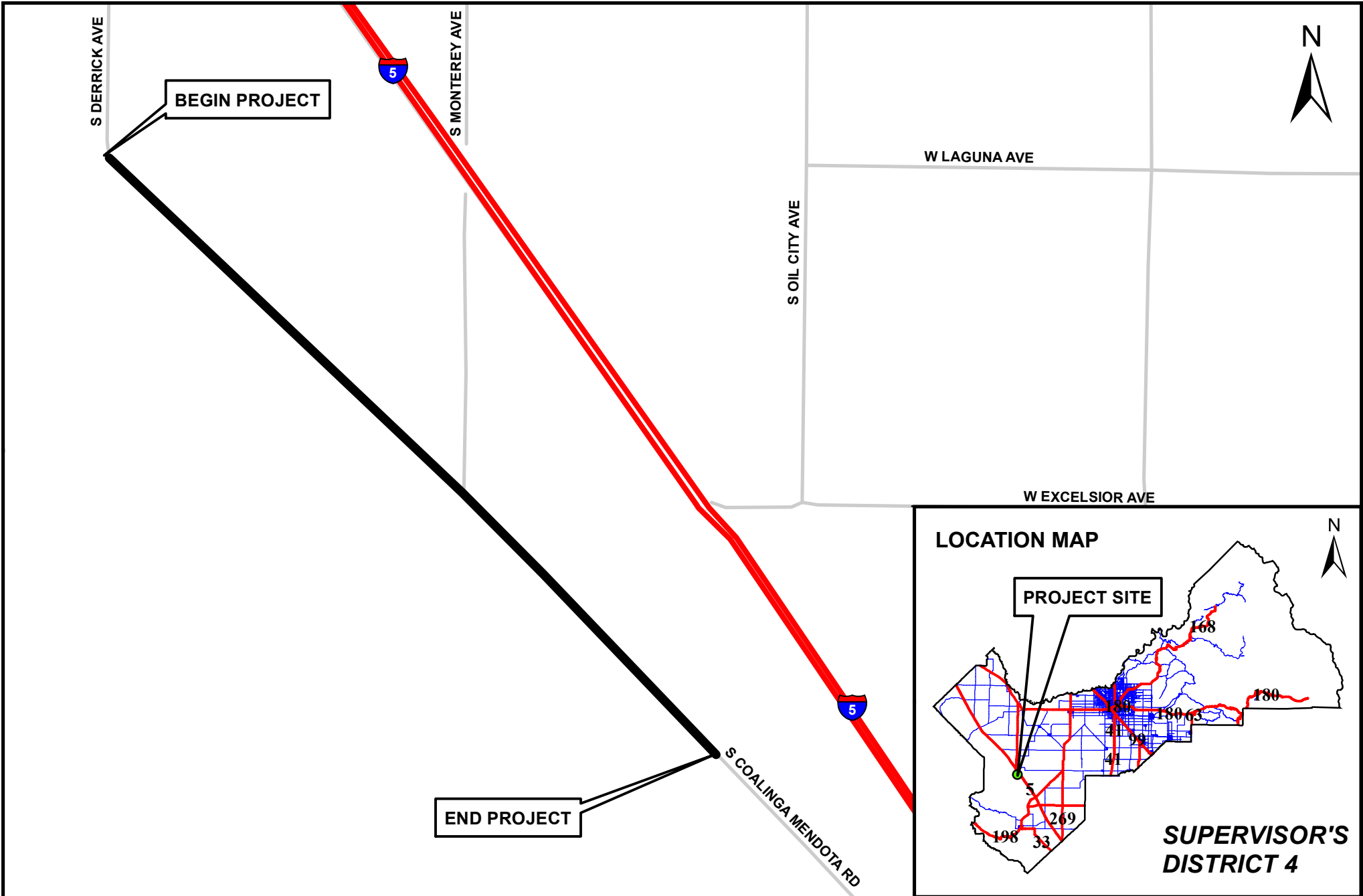

DATE:	
DESIGNED: C.M.	11/30/2020
DRAWN: C.M.	11/30/2020
CHECKED:	

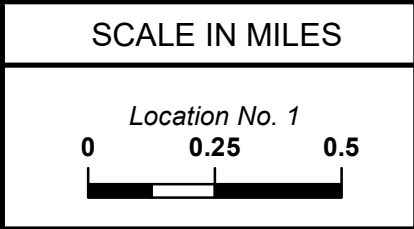

DEPARTMENT OF PUBLIC WORKS & PLANNING

2020-2021 BITUMINOUS SEAL COATS
S COALINGA-MENDOTA RD
S DERRICK AVE TO 2.500 MI SE/O S DERRICK AVE

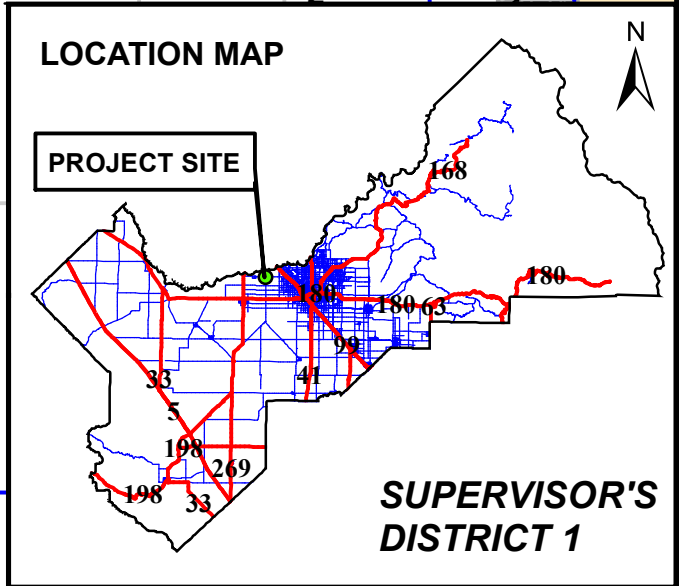
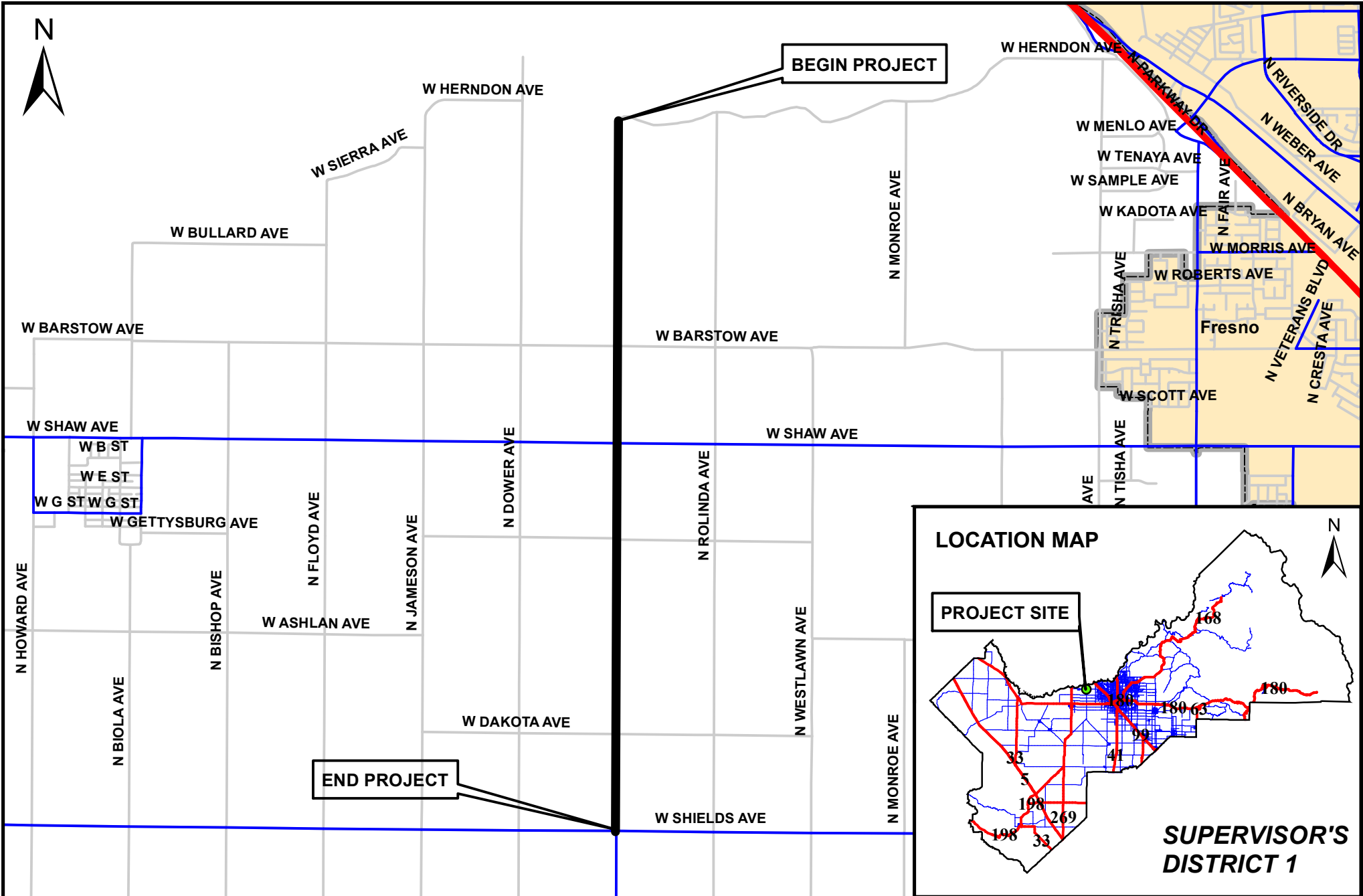

DATE:	
DESIGNED: C.M.	11/30/2020
DRAWN: C.M.	11/30/2020
CHECKED:	

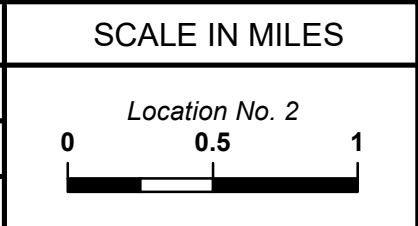

DEPARTMENT OF PUBLIC WORKS & PLANNING

**2020-2021 BITUMINOUS SEAL COATS
N DICKENSON AVE
W SHIELDS AVE TO W HERNDON AVE**

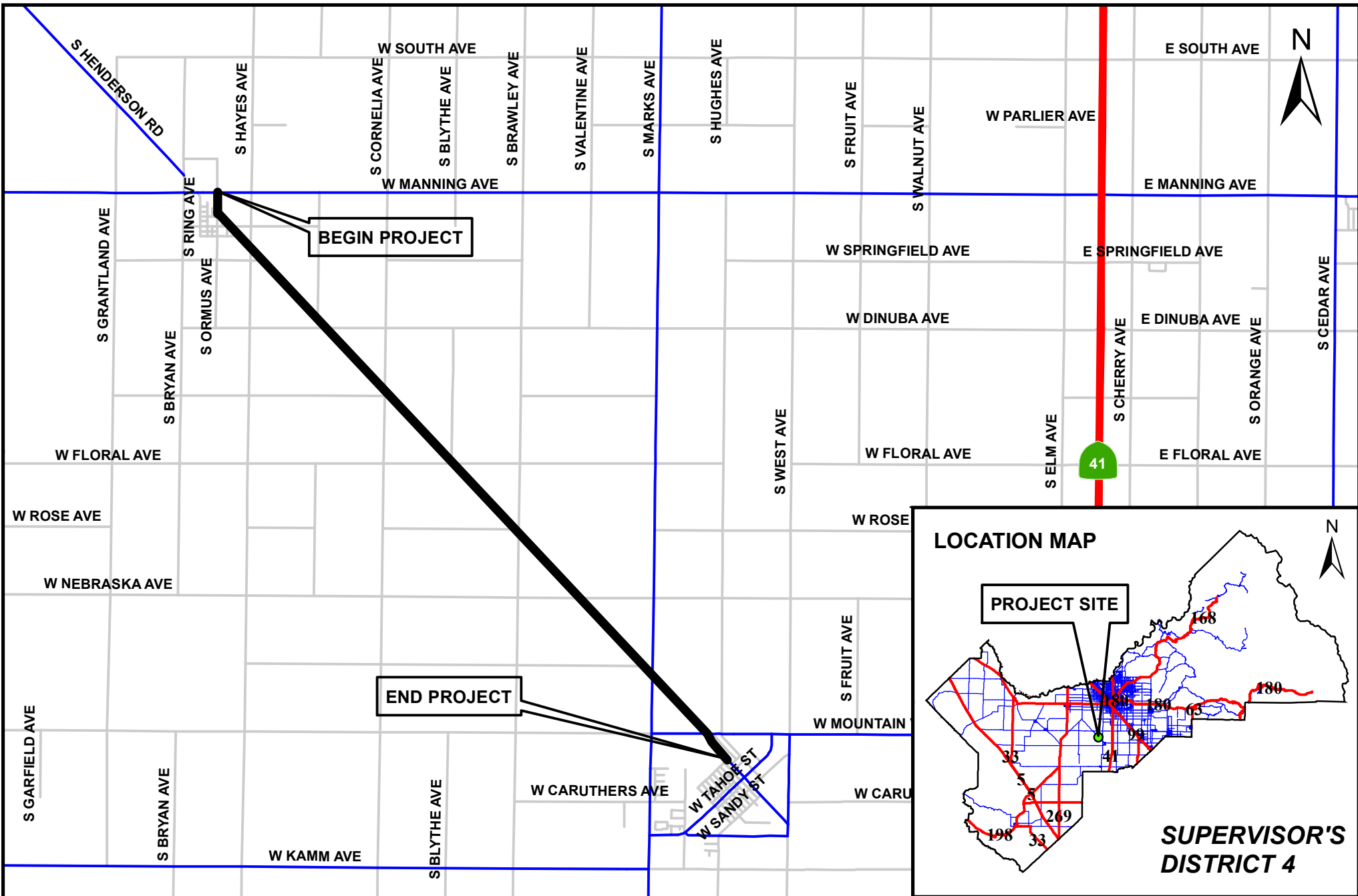

BEGIN PROJECT

END PROJECT

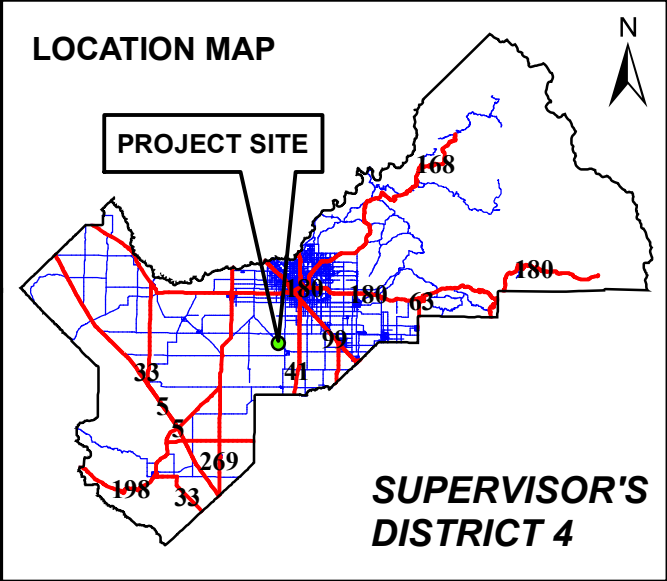

DATE:	
DESIGNED: C.M.	12/01/2020
DRAWN: C.M.	12/01/2020
CHECKED:	

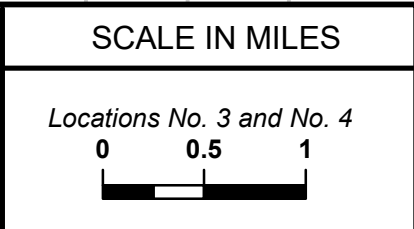

DEPARTMENT OF PUBLIC WORKS & PLANNING

2020-2021 BITUMINOUS SEAL COATS
LOC. 3 S HENDERSON RD - S ORMUS AVE TO W ONTARIO AVE
LOC. 4 S ORMUS AVE - W MANNING AVE TO S HENDERSON RD

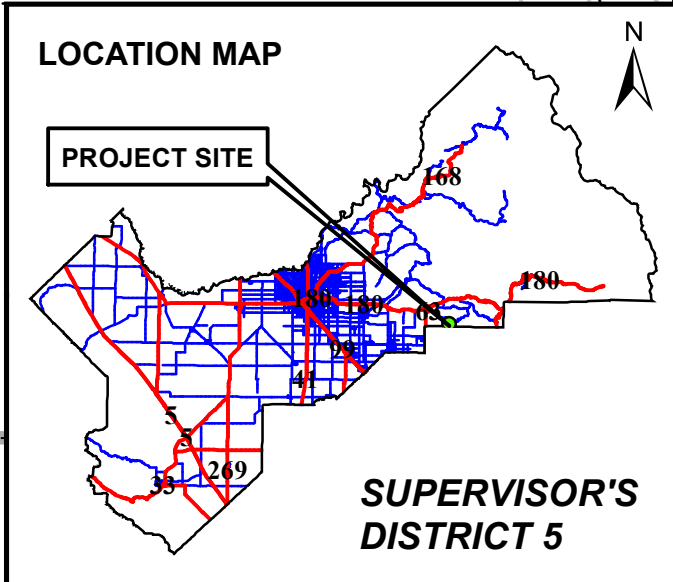
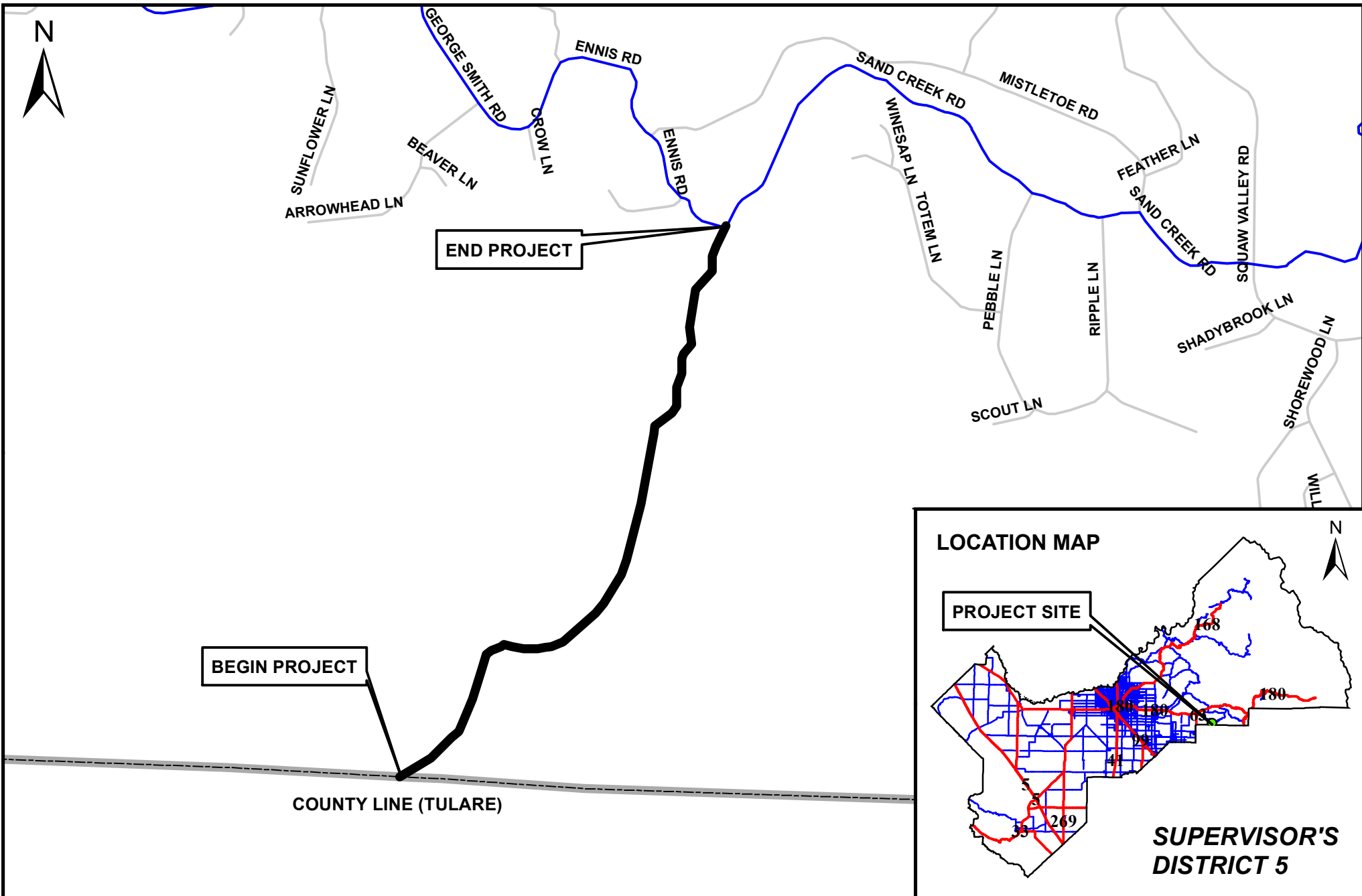

DATE:	
DESIGNED: C.M.	12/01/2020
DRAWN: C.M.	12/01/2020
CHECKED:	

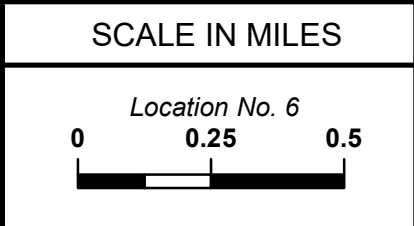

DEPARTMENT OF PUBLIC WORKS & PLANNING

2020-2021 BITUMINOUS SEAL COATS
SAND CREEK RD
COUNTY LINE (TULARE) TO ENNIS RD



Firebaugh

N FAIRFAX AVE

N JERROLD AVE

END PROJECT

BEGIN PROJECT

W NEES AVE

SANTA FE GR

W HERNDON AVE

N HUDSON AVE

N JERROLD AVE

W BULLARD AVE

LOCATION MAP



PROJECT SITE

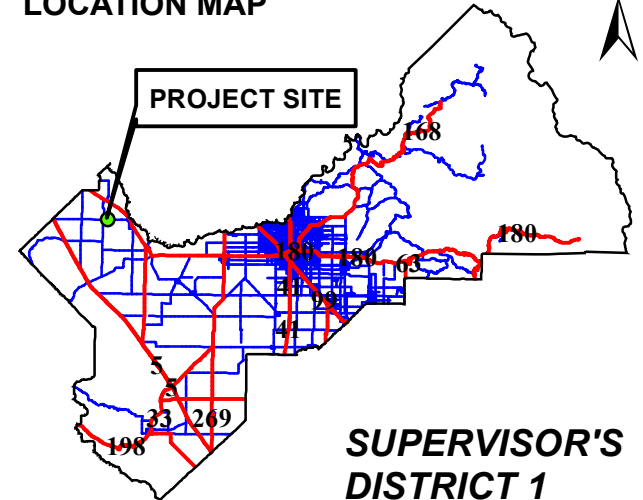

SUPERVISOR'S DISTRICT 1

DATE:

SCALE IN MILES

DEPARTMENT OF PUBLIC WORKS & PLANNING

DESIGNED: C.M. 12/01/2020

DRAWN: C.M. 12/01/2020

CHECKED:

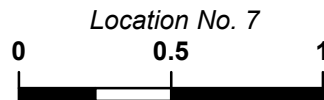

**2020-2021 BITUMINOUS SEAL COATS
W NEES AVE
N JERROLD AVE TO N FAIRFAX AVE**

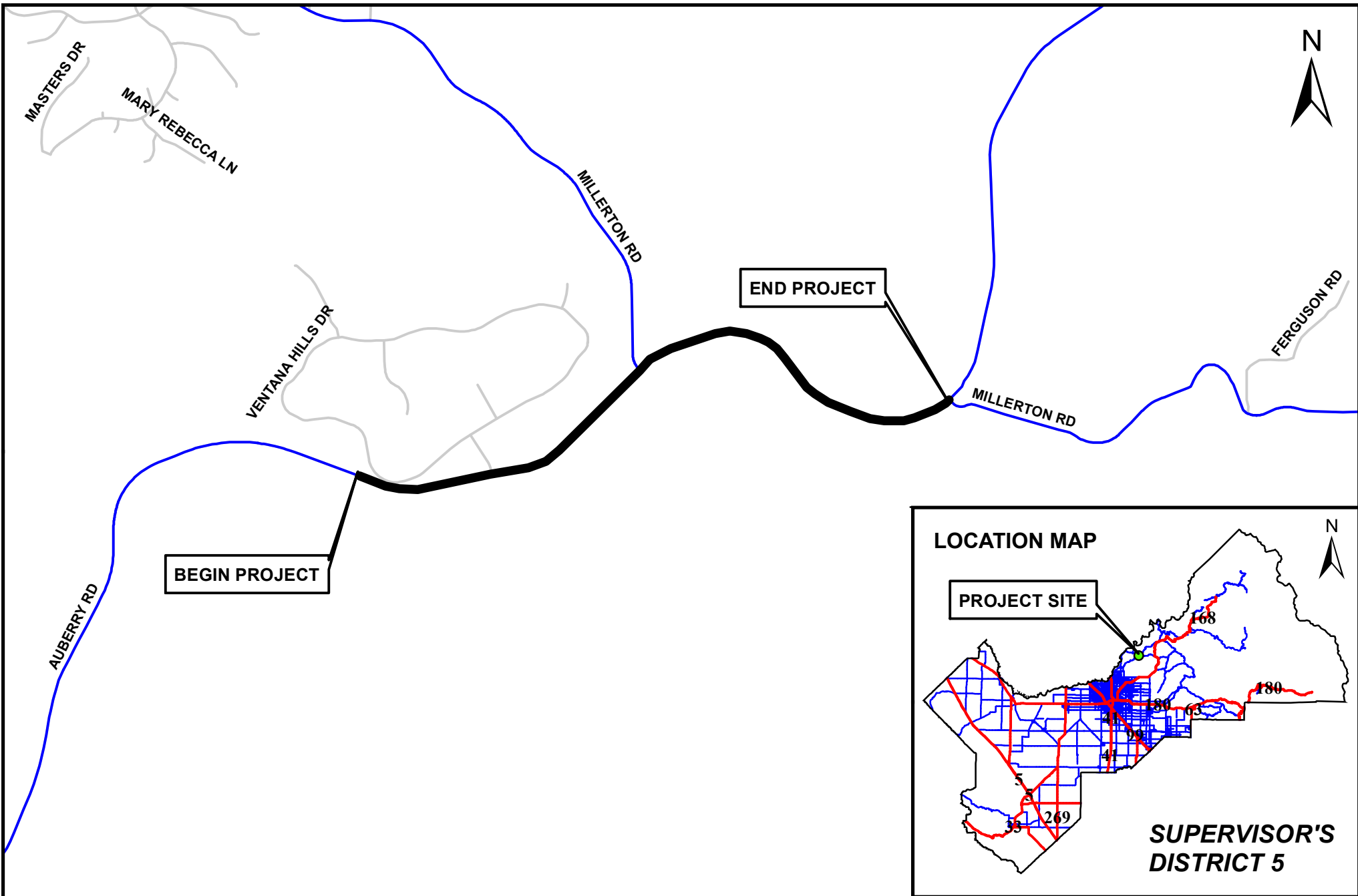

DATE:	
DESIGNED: C.M.	12/01/2020
DRAWN: C.M.	12/01/2020
CHECKED:	

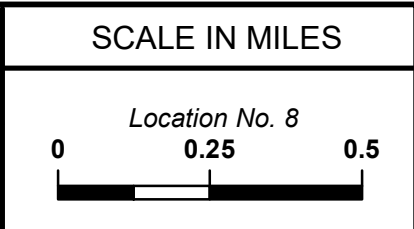

DEPARTMENT OF PUBLIC WORKS & PLANNING

2020-2021 BITUMINOUS SEAL COATS
AUBERRY RD
2.652 MI NE/O DRY CREEK RD TO E MILLERTON RD



SANTA FE GRD

W JEFFERSON AVE

END PROJECT

S SAN MATEO AVE

S TUOLUMNE ST

W LINCOLN AVE

W CLAYTON AVE

S CALAVERAS AVE

S ALPINE AVE

W AMERICAN AVE

BEGIN PROJECT

W JEFFERSON AVE

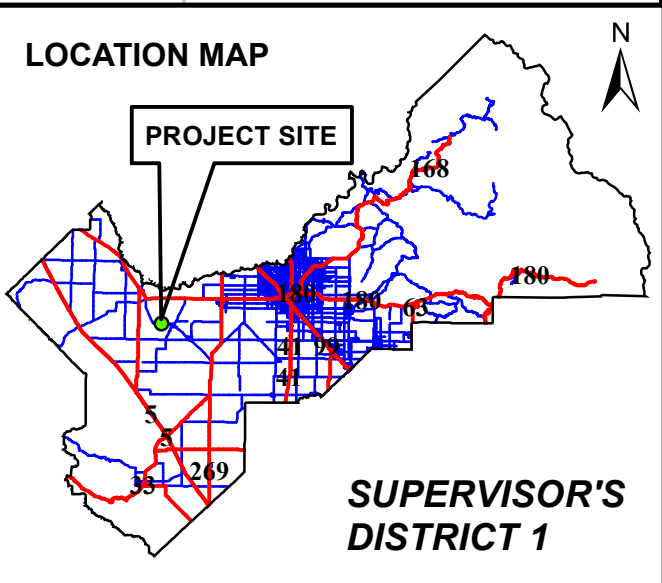

DATE:

SCALE IN MILES

DEPARTMENT OF PUBLIC WORKS & PLANNING

DESIGNED: C.M. 12/01/2020

DRAWN: C.M. 12/01/2020

CHECKED:

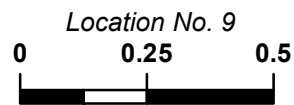

**2020-2021 BITUMINOUS SEAL COATS
W JEFFERSON AVE
W CALAVERAS AVE TO W SAN MATEO AVE**

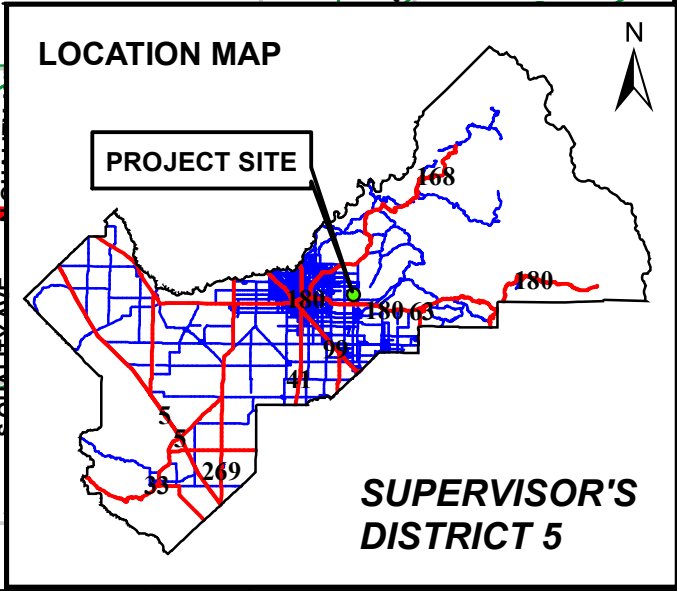
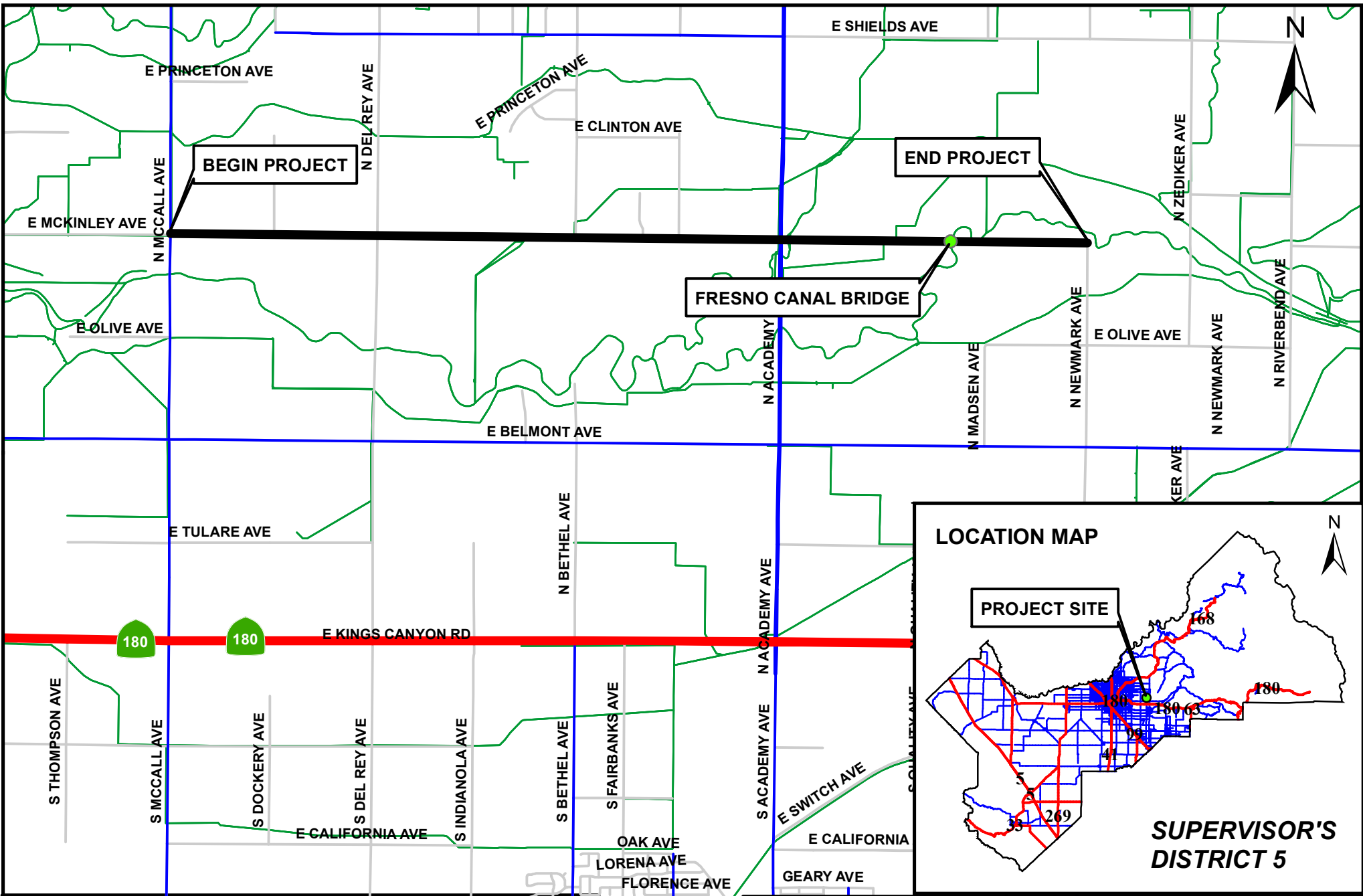

DATE:	
DESIGNED: C.M.	12/01/2020
DRAWN: C.M.	12/01/2020
CHECKED:	

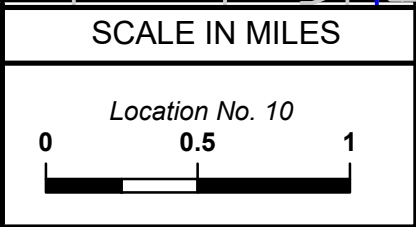

DEPARTMENT OF PUBLIC WORKS & PLANNING

**2020-2021 BITUMINOUS SEAL COATS
E MCKINLEY AVE
N MCCALL AVE TO N NEWMARK AVE**

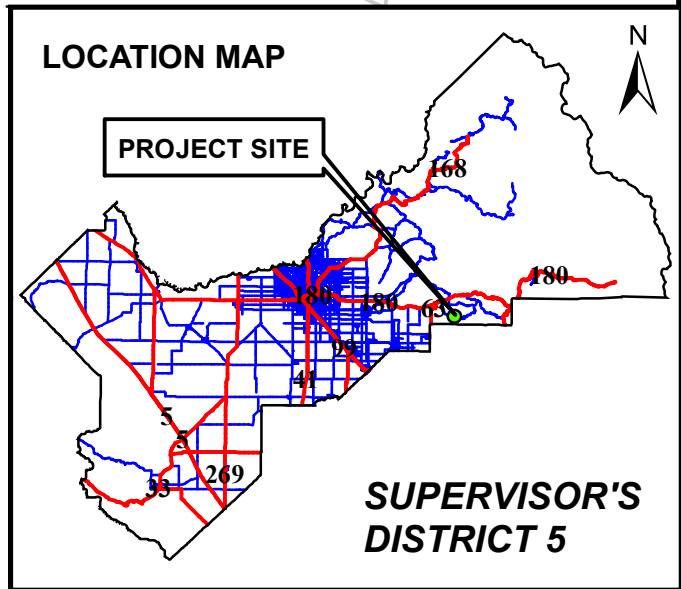
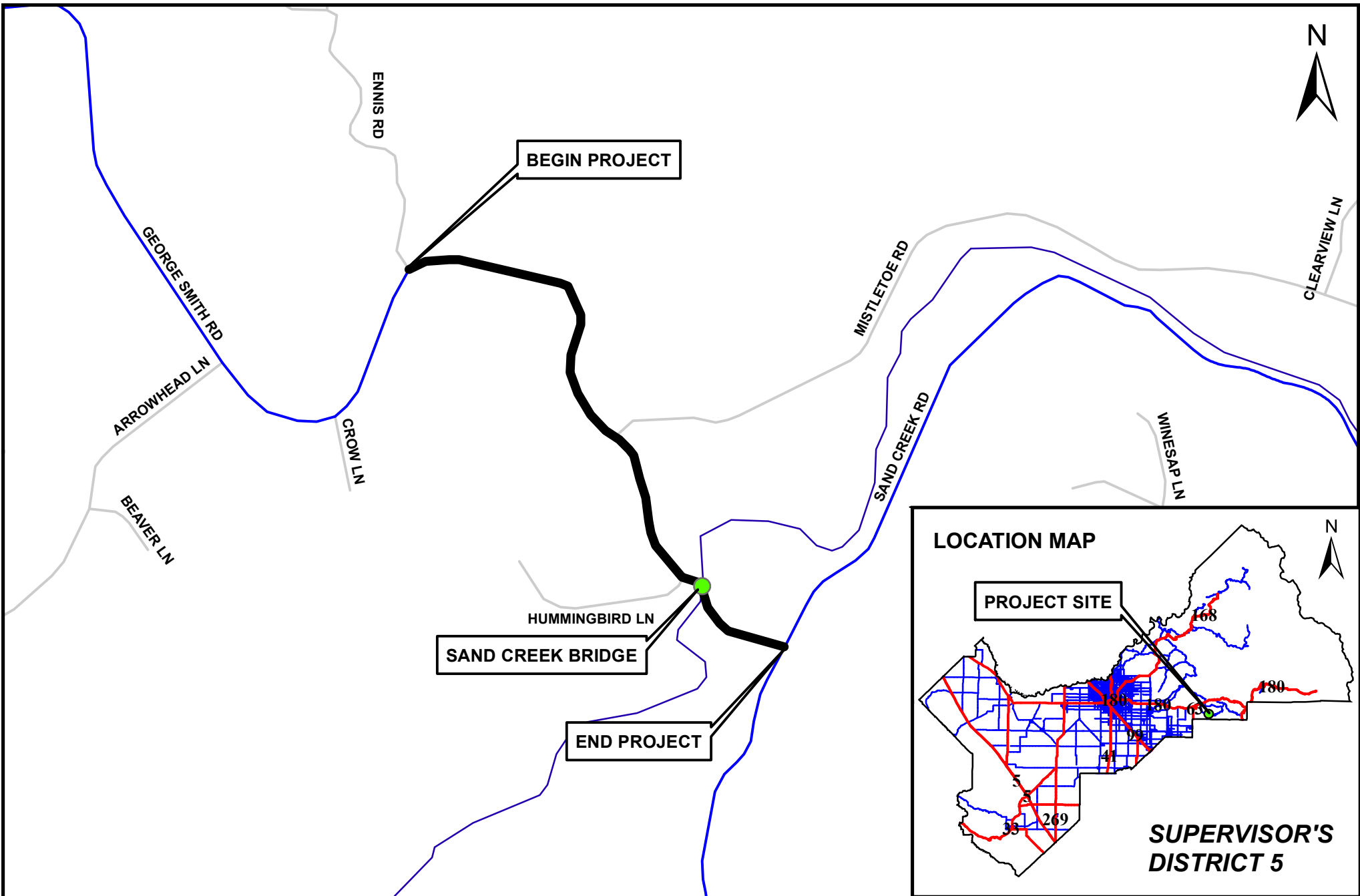

DATE:	
DESIGNED: C.M.	12/01/2020
DRAWN: C.M.	12/01/2020
CHECKED:	

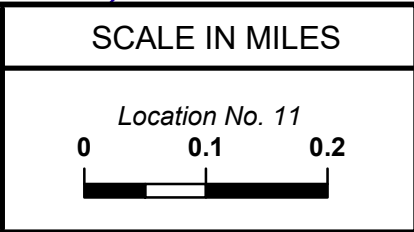

DEPARTMENT OF PUBLIC WORKS & PLANNING

2020-2021 BITUMINOUS SEAL COATS
ENNIS RD
GEORGE SMITH RD TO SAND CREEK RD

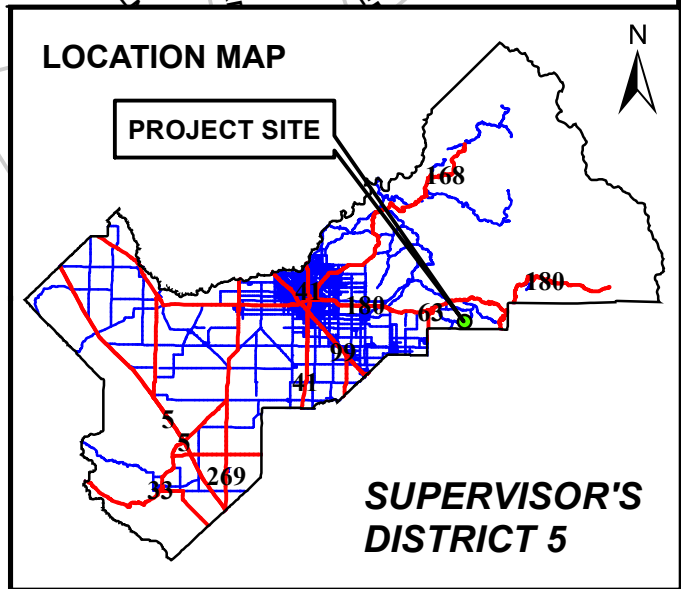
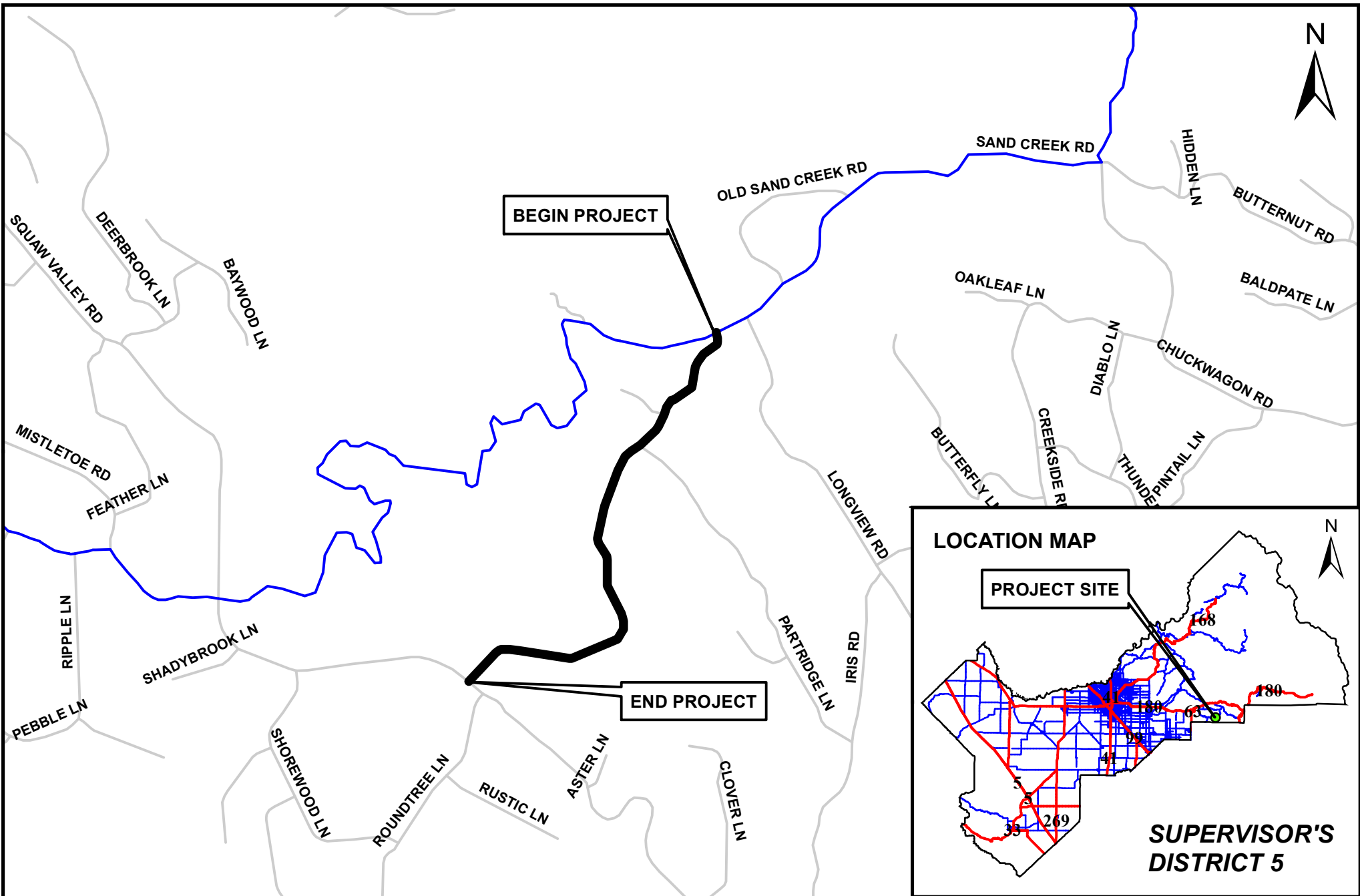

DATE:	
DESIGNED: C.M.	12/01/2020
DRAWN: C.M.	12/01/2020
CHECKED:	

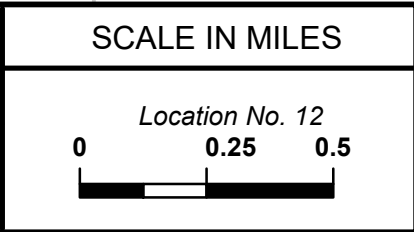

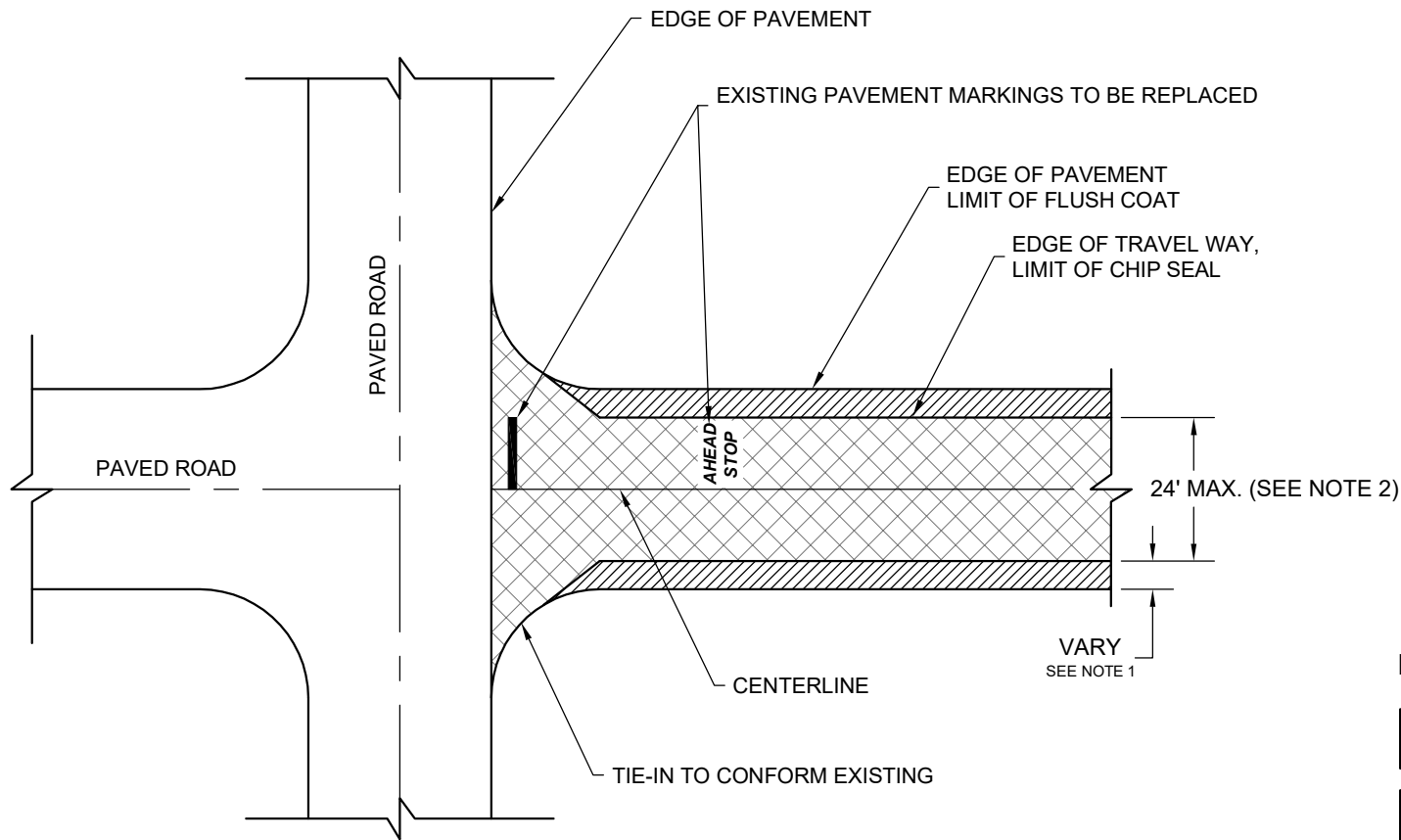

DEPARTMENT OF PUBLIC WORKS & PLANNING

2020-2021 BITUMINOUS SEAL COATS
PEPPERWEED RD
SAND CREEK RD TO SQUAW VALLEY RD



LEGEND

-  AREA TO BE CHIPPED
-  FLUSH COAT (SHOULDER)

NOTES

1. APPLY FLUSH COAT IN ENTIRE ROAD WIDTH (EDGE TO EDGE) INCLUDING EXISTING DIKES.
2. DIMENSION SHOWN IS FOR TRAVEL LANES.
3. CHIP EXISTING LT, ACC, DCC LANES, AND MEDIAN AREAS AT LOCATION 5 (MOUNTAIN VIEW) AND LOCATION 8 (AUBERRY).
4. PROTECT TRAFFIC STRIPE AND MARKING OUTSIDE OF CHIPPED AREA BEFORE APPLYING FLUSH COAT AT LOCATION 8, EXCEPT BIKELANE WITH ARROW SYMBOL.

CONTRACT NO. 20-14-M

	DATE:			
DESIGNED: T.T.	12/08/20	SCALE	NONE	
DRAWN: T.T.	12/08/20	DRAWING NO.		
CHECKED:				

DEPARTMENT OF PUBLIC WORKS AND PLANNING

TYPICAL CONSTRUCTION DETAILS
2020-2021 BITUMINOUS SEAL COATS
VARIOUS ROADS IN FRESNO COUNTY

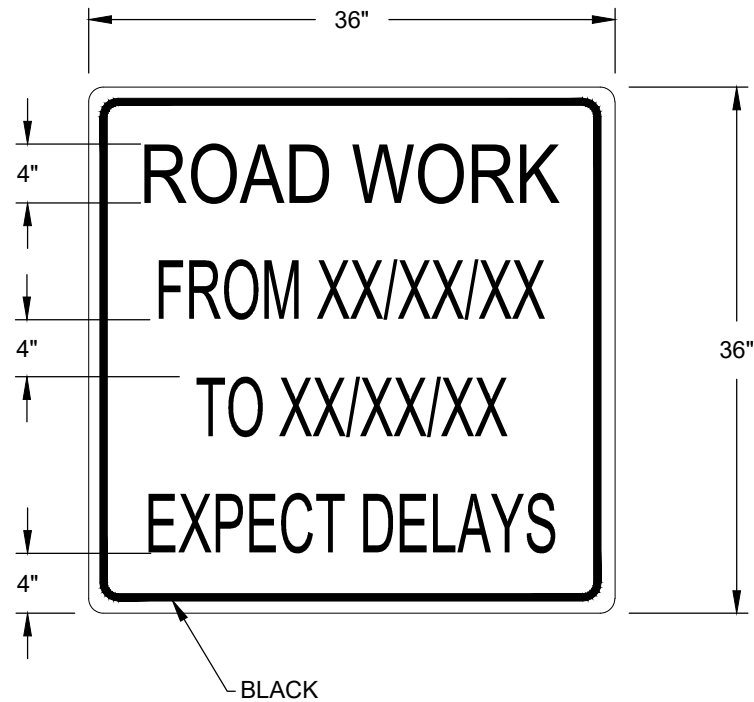

1. LETTERS SHALL BE BLACK, STYLE SHALL BE HIGHWAY "B"
2. BACKGROUND SHALL BE ORANGE
3. SIGN PANEL SHALL CONFORM TO SECTION 12 OF THE STATE STANDARD SPECIFICATIONS 2015

CONTRACT No. 20-14-M

		DATE:			DEPARTMENT OF PUBLIC WORKS AND PLANNING	
DESIGNED:	T.T.	12/08/20	SCALE		NONE	ADVANCED NOTIFICATION SIGN DETAIL 2020-2021 BITUMINOUS SEAL COATS VARIOUS ROADS
DRAWN:	T.T.	12/08/20	DRAWING NO.			
CHECKED:						

CENTERLINES (2 LANE HIGHWAYS)

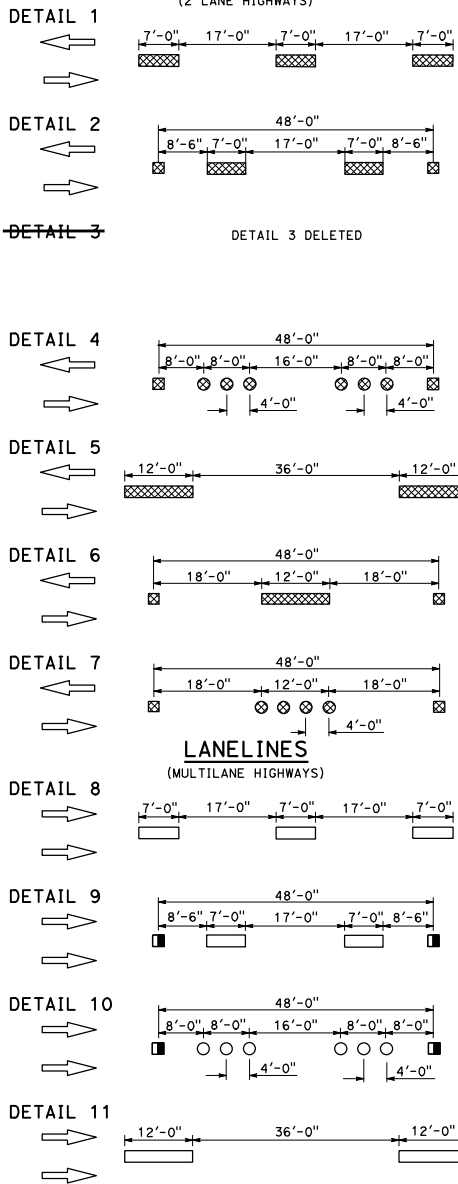

LANELINES (Cont)

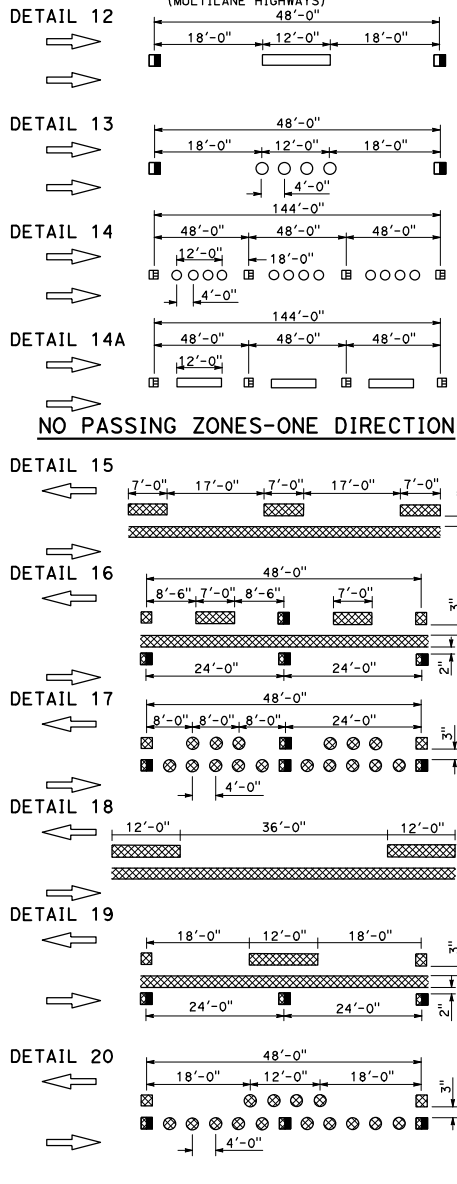

NO PASSING ZONES-TWO DIRECTION

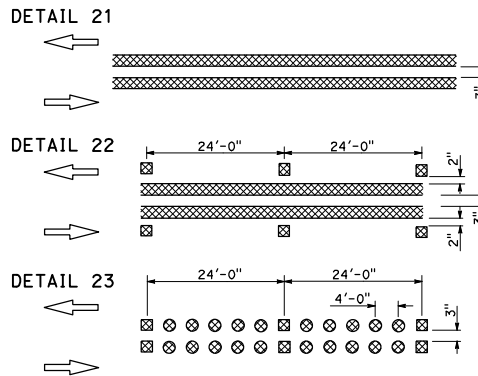

NO PASSING ZONES-ONE DIRECTION

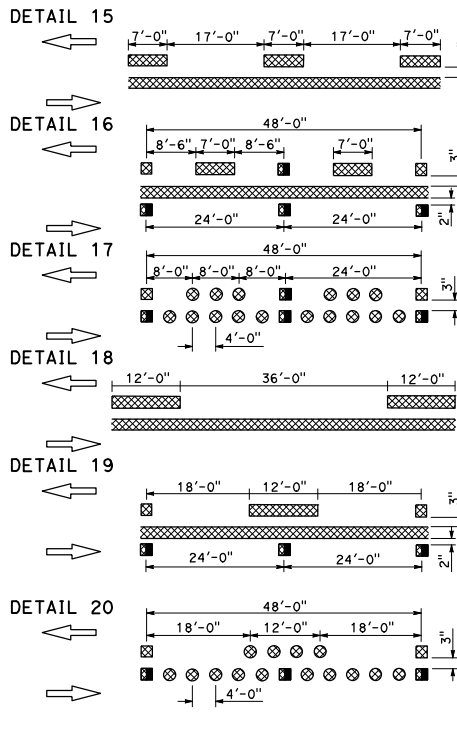

DIST	COUNTY	ROUTE	POST MILES TOTAL PROJECT	SHEET NO.	TOTAL SHEETS

Atifa Ferouz
REGISTERED CIVIL ENGINEER

October 30, 2015
PLANS APPROVAL DATE

Atifa Ferouz
REGISTERED PROFESSIONAL ENGINEER
No. C80402
Exp. 3-31-17
CIVIL
STATE OF CALIFORNIA

THE STATE OF CALIFORNIA OR ITS OFFICERS OR AGENTS SHALL NOT BE RESPONSIBLE FOR THE ACCURACY OR COMPLETENESS OF SCANNED COPIES OF THIS PLAN SHEET.

TYPICAL LANE LINE DELINEATION IN ADVANCE OF EXIT RAMP

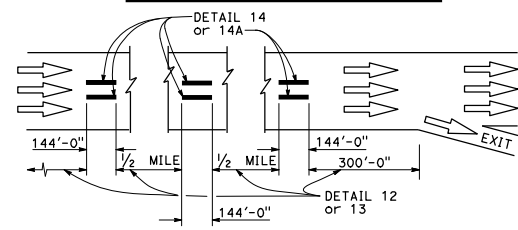

- #### LEGEND
- MARKERS**
- TYPE A WHITE NON-REFLECTIVE
 - ⊗ TYPE AY YELLOW NON-REFLECTIVE
 - ▣ TYPE C RED-CLEAR RETROREFLECTIVE
 - ⊠ TYPE D TWO-WAY YELLOW RETROREFLECTIVE
 - TYPE G ONE-WAY CLEAR RETROREFLECTIVE
 - ⊞ TYPE H ONE-WAY YELLOW RETROREFLECTIVE
- LINES**
- ▭ 4" WHITE
 - ▨ 4" YELLOW

NOTE:
Detail 14 is to be used in combination with Detail 13. Detail 14A is to be used in combination with Detail 12.

MARKER DETAILS

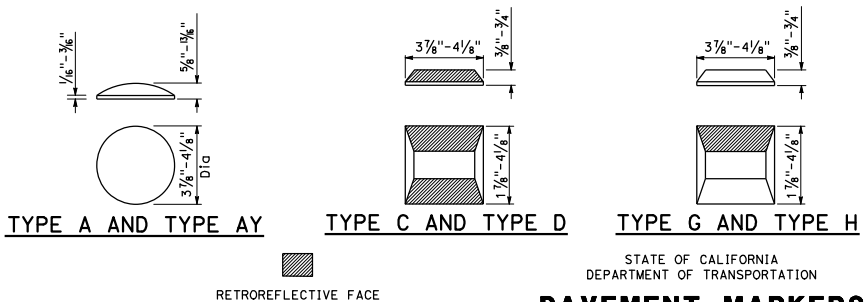

TYPE A AND TYPE AY TYPE C AND TYPE D TYPE G AND TYPE H

RETROREFLECTIVE FACE

STATE OF CALIFORNIA
DEPARTMENT OF TRANSPORTATION

**PAVEMENT MARKERS
AND TRAFFIC LINES
TYPICAL DETAILS**

NO SCALE **A20A**

LEFT EDGELINES (DIVIDED HIGHWAYS)

DETAIL 24

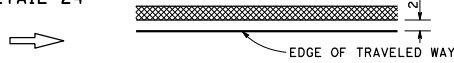

DETAIL 25

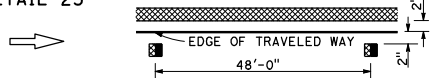

DETAIL 25A

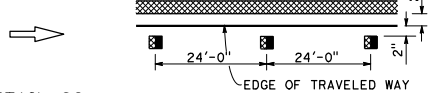

DETAIL 26

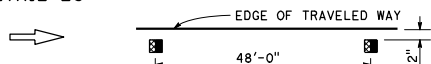

DETAIL 27

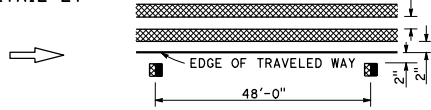

RIGHT EDGELINES

DETAIL 27A

DETAIL 27A DELETED

DETAIL 27B

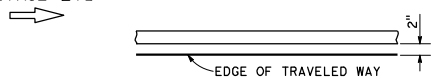

RIGHT EDGELINE EXTENSION THROUGH INTERSECTIONS

DETAIL 27C

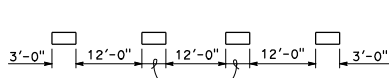

MEDIAN ISLANDS

DETAIL 28



DETAIL 29

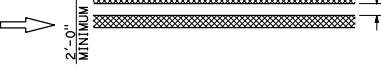

DETAIL 30

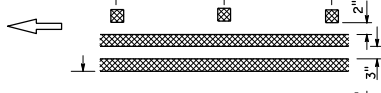

DETAIL 31



DETAIL 32

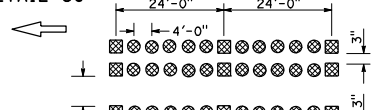

DETAIL 33

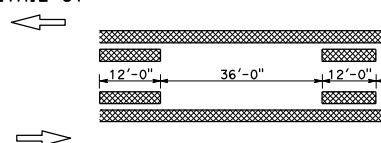

TWO-WAY LEFT TURN LANES

DETAIL 34

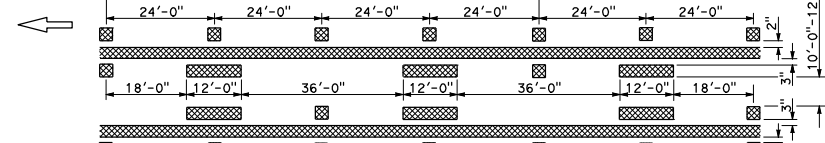

DETAIL 35

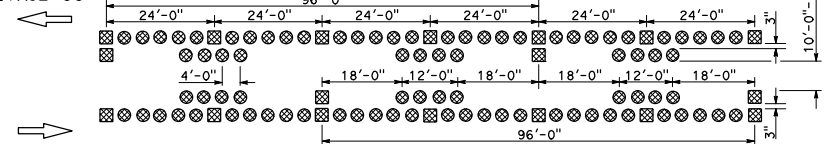

LEGEND

MARKERS

- TYPE AY YELLOW NON-REFLECTIVE
- ⊗ TYPE D TWO-WAY YELLOW RETROREFLECTIVE
- ⊠ TYPE H ONE-WAY YELLOW RETROREFLECTIVE

LINES

- ▭ 4" WHITE
- ▨ 4" YELLOW

INTERSECTION TREATMENTS

DETAIL 34

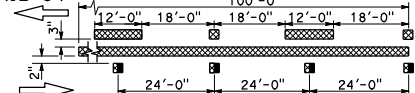

DETAIL 34A

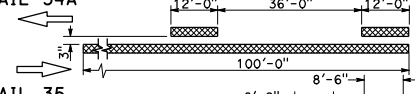

DETAIL 35

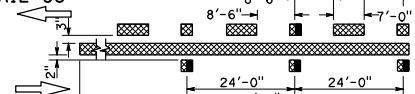

DETAIL 35A

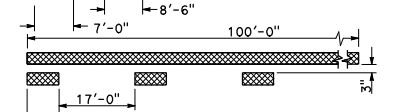
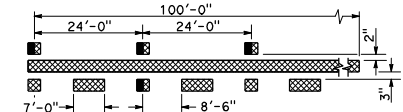
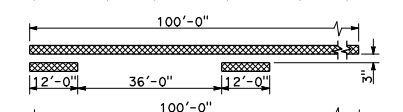
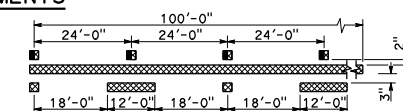
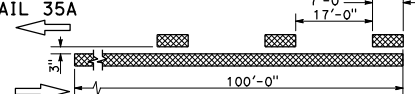

MARKER DETAILS

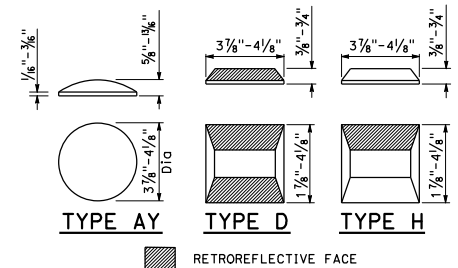

STATE OF CALIFORNIA
DEPARTMENT OF TRANSPORTATION
PAVEMENT MARKERS AND TRAFFIC LINES TYPICAL DETAILS
NO SCALE

A20B

D16+	COUNTY	ROUTE	POST MILES TOTAL PROJECT	SHEET NO.	TOTAL SHEETS

Atifa Ferouz
REGISTERED CIVIL ENGINEER

October 30, 2015
PLANS APPROVAL DATE

Atifa Ferouz
No. C80402
Exp. 3-31-17
CIVIL ENGINEER PROFESSIONAL ENGINEER
STATE OF CALIFORNIA

THE STATE OF CALIFORNIA OR ITS OFFICERS OR AGENTS SHALL NOT BE RESPONSIBLE FOR THE ACCURACY OR COMPLETENESS OF SCANNED COPIES OF THIS PLAN SHEET.

CHANNELIZING LINE

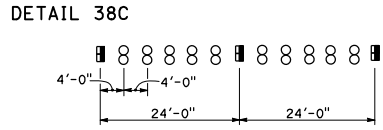
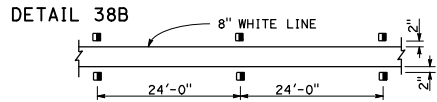
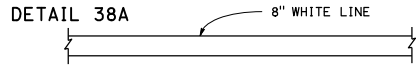
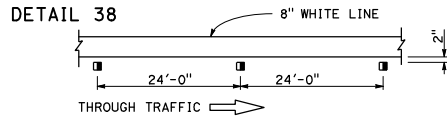

BIKE LANE LINE

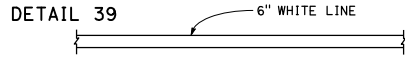

INTERSECTION LINE BIKE LANE

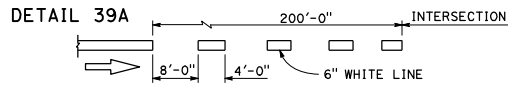

LANE LINE EXTENSIONS THROUGH INTERSECTIONS

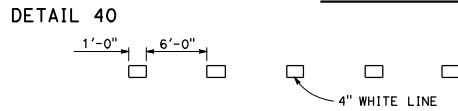

CENTER LINE EXTENSIONS THROUGH INTERSECTIONS

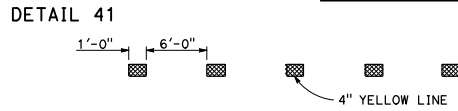

LEGEND

MARKERS

- TYPE A WHITE NON-REFLECTIVE
- ⊗ TYPE AY YELLOW NON-REFLECTIVE
- TYPE G ONE-WAY CLEAR RETROREFLECTIVE
- ▨ 4" YELLOW LINE

MARKER DETAILS

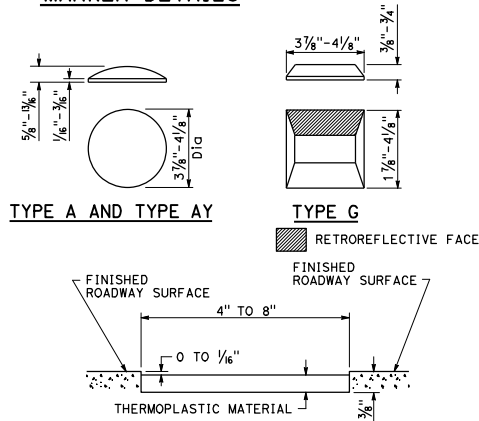

DETAIL FOR RECESSED THERMOPLASTIC TRAFFIC STRIPE

See Notes A and B.

RECESSED THERMOPLASTIC NOTES

- A. See typical traffic line details for pavement marking patterns.
- B. The top of the thermoplastic installed in recessed pavement shall be 0 to 1/16" below the pavement surface.

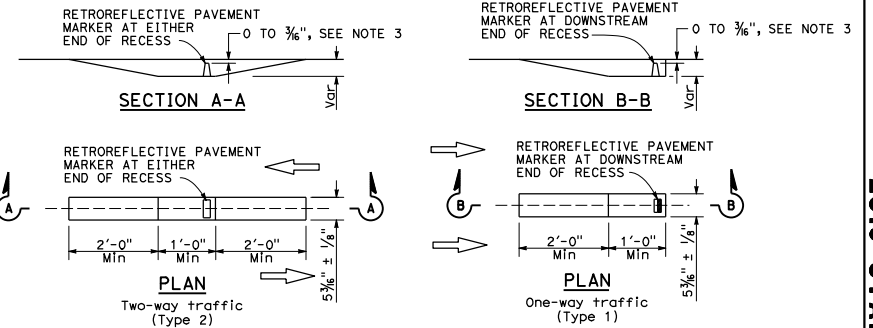
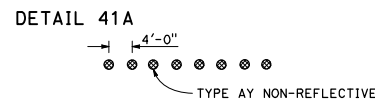
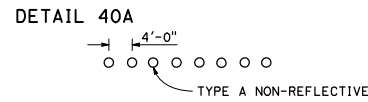

RECESS DETAIL FOR RETROREFLECTIVE PAVEMENT MARKER

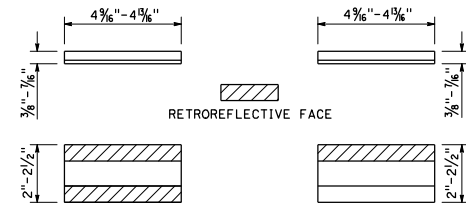

TYPE C AND TYPE D TYPE G AND TYPE H

See Notes 1 and 2.

RETROREFLECTIVE PAVEMENT MARKER FOR RECESSED INSTALLATION

STATE OF CALIFORNIA DEPARTMENT OF TRANSPORTATION

PAVEMENT MARKERS AND TRAFFIC LINES TYPICAL DETAILS

NO SCALE

A20D

D16+	COUNTY	ROUTE	POST MILES TOTAL PROJECT	SHEET TOTAL SHEETS

Atifa Ferouz
REGISTERED CIVIL ENGINEER

October 30, 2015
PLANS APPROVAL DATE

Atifa Ferouz
No. C80402
Exp. 3-31-17
CIVIL
STATE OF CALIFORNIA

THE STATE OF CALIFORNIA OR ITS OFFICERS OR AGENTS SHALL NOT BE RESPONSIBLE FOR THE ACCURACY OR COMPLETENESS OF SCANNED COPIES OF THIS PLAN SHEET.

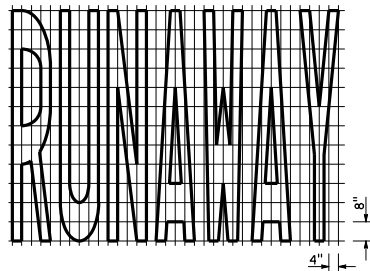

A=43 ft²

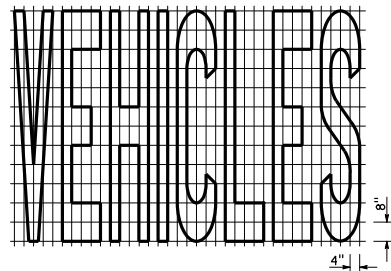

A=42 ft²

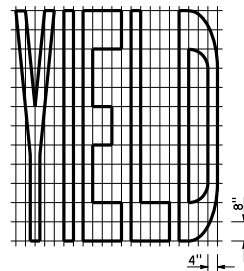

A=24 ft²

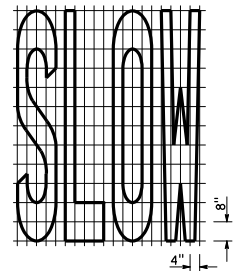

A=23 ft²

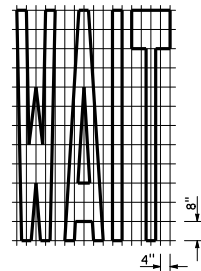

A=19 ft²

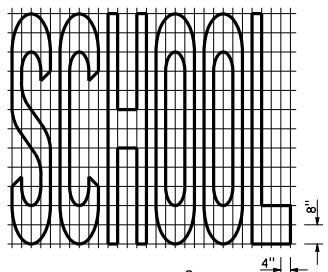

A=35 ft²

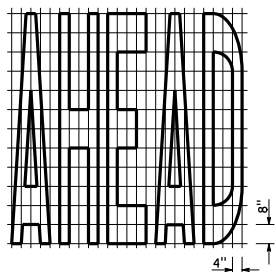

A=31 ft²

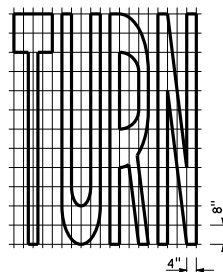

A=24 ft²

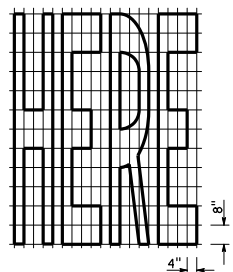

A=26 ft²

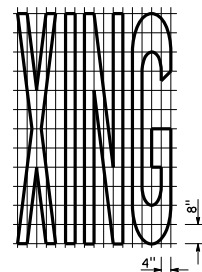

A=21 ft²

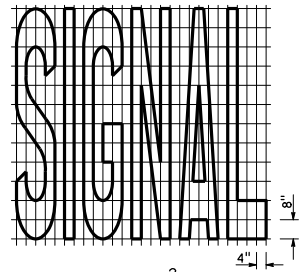

A=32 ft²

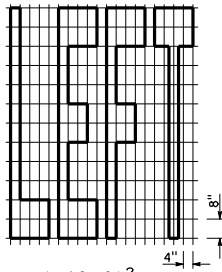

A=19 ft²

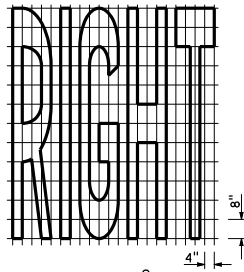

A=26 ft²

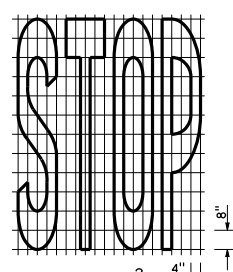

A=22 ft²

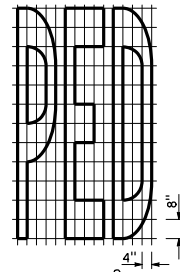

A=18 ft²

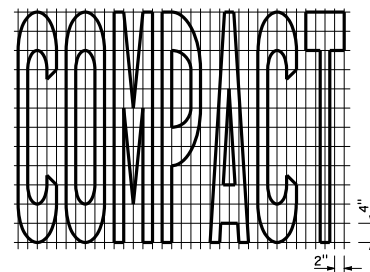

A=10 ft²

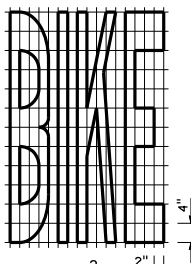

A=5 ft²

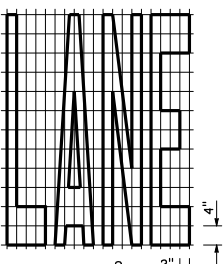

A=6 ft²

Dist	COUNTY	ROUTE	POST MILES TOTAL PROJECT	SHEET TOTAL SHEETS

Atifa Ferouz
REGISTERED CIVIL ENGINEER

October 30, 2015
PLANS APPROVAL DATE

Atifa Ferouz
No. C80402
Exp. 3-31-17
CIVIL
STATE OF CALIFORNIA

THE STATE OF CALIFORNIA OR ITS OFFICERS OR AGENTS SHALL NOT BE RESPONSIBLE FOR THE ACCURACY OR COMPLETENESS OF SCANNED COPIES OF THIS PLAN SHEET.

NOTES:

1. If a message consists of more than one word, it must read "UP", i.e., the first word must be nearest the driver.
2. The space between words must be at least four times the height of the characters for low speed roads, but not more than ten times the height of the characters. The space may be reduced appropriately where there is limited space because of local conditions.
3. Minor variations in dimensions may be accepted by the Engineer.
4. Portions of a letter, number or symbol may be separated by connecting segments not to exceed 2" in width.

WORD MARKINGS					
ITEM	ft ²	ITEM	ft ²	ITEM	ft ²
XING	21	YIELD	24	BIKE	5
AHEAD	31	SCHOOL	35	SLOW	23
WAIT	19	SIGNAL	32	STOP	22
LANE	6	TURN	24	LEFT	19
RIGHT	26	HERE	26	VEHICLES	42

STATE OF CALIFORNIA
DEPARTMENT OF TRANSPORTATION
**PAVEMENT MARKINGS
WORDS**
NO SCALE

A24D

2015 STANDARD PLAN A24D

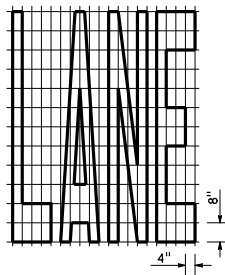

A=24 f+2

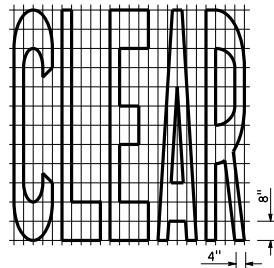

A=27 f+2

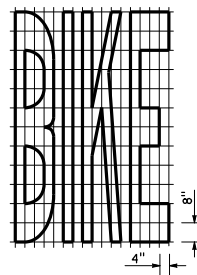

A=21 f+2

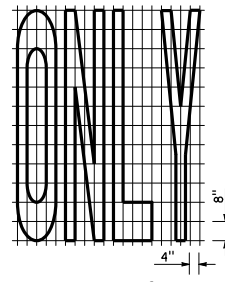

A=22 f+2

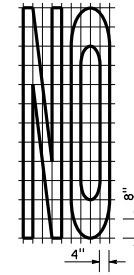

A=14 f+2

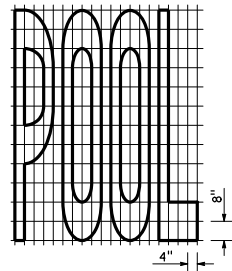

A=23 f+2

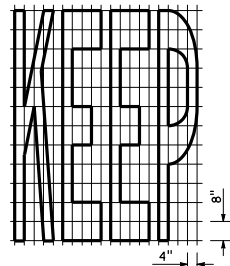

A=24 f+2

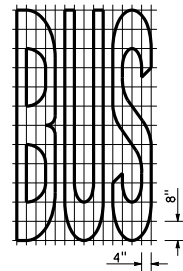

A=20 f+2

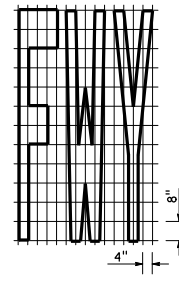

A=16 f+2

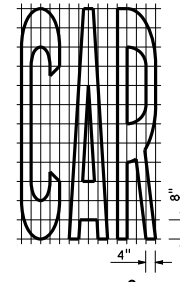

A=17 f+2

DIST	COUNTY	ROUTE	POST MILES TOTAL PROJECT	SHEET TOTAL SHEETS

Atifa Ferouz
REGISTERED CIVIL ENGINEER

October 30, 2015
PLANS APPROVAL DATE

Atifa Ferouz
No. C80402
Exp. 3-31-17
CIVIL
STATE OF CALIFORNIA

THE STATE OF CALIFORNIA OR ITS OFFICERS OR AGENTS SHALL NOT BE RESPONSIBLE FOR THE ACCURACY OR COMPLETENESS OF SCANNED COPIES OF THIS PLAN SHEET.

WORD MARKINGS			
ITEM	f+2	ITEM	f+2
LANE	24	NO	14
POOL	23	BIKE	21
CAR	17	BUS	20
CLEAR	27	ONLY	22
KEEP	24	FWY	16

NOTES:

1. If a message consists of more than one word, it must read "UP", i.e., the first word must be nearest the driver.
2. The space between words must be at least four times the height of the characters for low speed roads, but not more than ten times the height of the characters. The space may be reduced appropriately where there is limited space because of local conditions.
3. Minor variations in dimensions may be accepted by the Engineer.
4. Portions of a letter, number or symbol may be separated by connecting segments not to exceed 2" in width.
5. The words "NO PARKING" pavement marking is to be used for parking facilities. For typical locations of markings, see Standard Plans A90A and A90B.
6. The words "NO PARKING", shall be painted in white letters no less than 1'-0" high on a contrasting background and located so that it is visible to traffic enforcement officials.

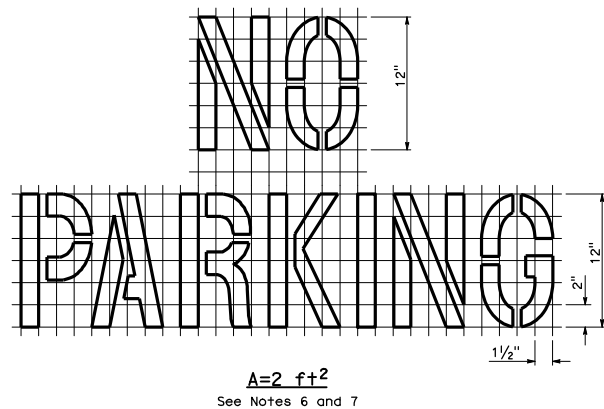

A=2 f+2
See Notes 6 and 7

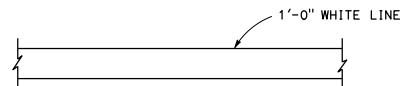

LIMIT LINE (STOP LINE)

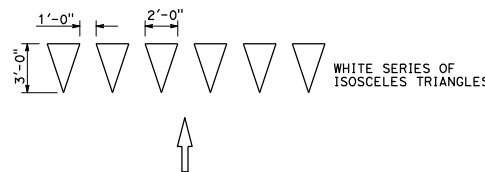

YIELD LINE

STATE OF CALIFORNIA
DEPARTMENT OF TRANSPORTATION
PAVEMENT MARKINGS
WORDS, LIMIT AND YIELD LINES

NO SCALE

A24E

Dist	COUNTY	ROUTE	POST MILES TOTAL PROJECT	SHEET TOTAL NO. SHEETS

Devinder Singh
REGISTERED CIVIL ENGINEER

January 20, 2017
PLANS APPROVAL DATE

THE STATE OF CALIFORNIA OR ITS OFFICERS OR AGENTS SHALL NOT BE RESPONSIBLE FOR THE ACCURACY OR COMPLETENESS OF SCANNED COPIES OF THIS PLAN SHEET.

TO ACCOMPANY PLANS DATED _____

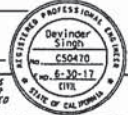

TABLE 1

SPEED (S)	MINIMUM TAPER LENGTH * FOR WIDTH OF OFFSET 12 FEET (W)				MAXIMUM CHANNELIZING DEVICE SPACING		
	TANGENT	MERGING	SHIFTING	SHOULDER	X	Y	Z **
	2L	L	L/2	L/3	TAPER	TANGENT	CONFLICT
mph	ft	ft	ft	ft	ft	ft	ft
20	160	80	40	27	20	40	10
25	250	125	63	42	25	50	12
30	360	180	90	60	30	60	15
35	490	245	123	82	35	70	17
40	640	320	160	107	40	80	20
45	1080	540	270	180	45	90	22
50	1200	600	300	200	50	100	25
55	1320	660	330	220	50	100	25
60	1440	720	360	240	50	100	25
65	1560	780	390	260	50	100	25
70	1680	840	420	280	50	100	25
75	1800	900	450	300	50	100	25

* - For other offsets, use the following merging taper length formula for L:
For speed of 40 mph or less, $L = WS^2/60$
For speed of 45 mph or more, $L = WS$

Where: L = Taper length in feet

W = Width of offset in feet

S = Posted speed limit, off-peak 85th-percentile speed prior to work starting, or the anticipated operating speed in mph

** - Use for taper and tangent sections where there are no pavement markings or where there is a conflict between existing pavement markings and channelizers (CA).

TABLE 2

SPEED *	Min D **	DOWNGRADE Min D ***		
		-3%	-6%	-9%
		ft	ft	ft
mph	ft	ft	ft	ft
20	115	116	120	126
25	155	158	165	173
30	200	205	215	227
35	250	257	271	287
40	305	315	333	354
45	360	378	400	427
50	425	446	474	507
55	495	520	553	593
60	570	598	638	686
65	645	682	728	785
70	730	771	825	891
75	820	866	927	1003

* - Speed is posted speed limit, off-peak 85th-percentile speed prior to work starting, or the anticipated operating speed in mph

** - Longitudinal buffer space or flagger station spacing

*** - Use on sustained downgrade steeper than -3 percent and longer than 1 mile.

TABLE 3

ROAD TYPE	DISTANCE BETWEEN SIGNS *		
	A	B	C
	ft	ft	ft
URBAN - 25 mph OR LESS	100	100	100
URBAN - MORE THAN 25 mph TO 40 mph	250	250	250
URBAN - MORE THAN 40 mph	350	350	350
RURAL	500	500	500
EXPRESSWAY / FREEWAY	1000	1500	2640

* - The distances are approximate, are intended for guidance purposes only, and should be applied with engineering judgment. These distances should be adjusted by the Engineer for field conditions, if necessary, by increasing or decreasing the recommended distances.

STATE OF CALIFORNIA
DEPARTMENT OF TRANSPORTATION

**TRAFFIC CONTROL SYSTEM TABLES
FOR LANE AND RAMP CLOSURES**

NO SCALE

RSP T9 DATED JANUARY 20, 2017 SUPERSEDES STANDARD PLAN T9
DATED OCTOBER 30, 2015 - PAGE 249 OF THE STANDARD PLANS BOOK DATED 2015.

REVISED STANDARD PLAN RSP T9

2015 REVISED STANDARD PLAN RSP T9

NOTES:

See Standard Plan T9 for tables.

Use cone spacing X for taper segment, Y for tangent segment or Z for conflict situations, as appropriate, per Table 1, unless X, Y, or Z cone spacing is shown on this sheet.

All temporary warning signs shall have black legend on fluorescent orange background.

California codes are designated by (CA). Otherwise, Federal (MUTCD) codes are shown.

D16+	COUNTY	ROUTE	POST MILES TOTAL PROJECT	SHEET TOTAL SHEETS

Devinder Singh
REGISTERED CIVIL ENGINEER

October 30, 2015
PLANS APPROVAL DATE

Devinder Singh
No. C50470
Exp. 6-30-17
CIVIL ENGINEER PROFESSIONAL SEAL
STATE OF CALIFORNIA

THE STATE OF CALIFORNIA OR ITS OFFICERS OR AGENTS SHALL NOT BE RESPONSIBLE FOR THE ACCURACY OR COMPLETENESS OF SCANNED COPIES OF THIS PLAN SHEET.

TYPICAL LANE CLOSURE WITH REVERSIBLE CONTROL

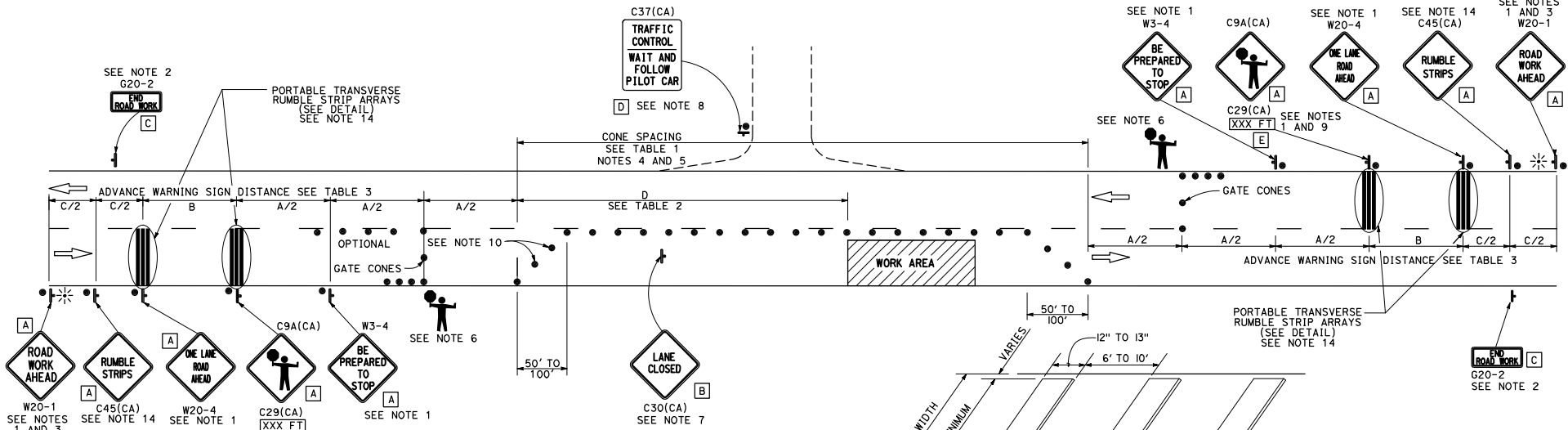

NOTES:

- Each advance warning sign in each direction of travel shall be equipped with at least two flags for daytime closure. Each flag shall be at least 16" x 16" in size and shall be orange or fluorescent red-orange in color. Flashing beacons shall be placed at the locations indicated for lane closure during hours of darkness.
- A G20-2 "END ROAD WORK" sign, as appropriate, shall be placed at the end of the lane control unless the end of work area is obvious, or ends within a larger project's limits.
- If the W20-1 sign would follow within 2000' of a stationary W20-1 or G20-1 "ROAD WORK NEXT _____ MILES", use a W20-4 sign for the first advance warning sign.
- All cones used for lane closures during the hours of darkness shall be fitted with retroreflective bands (or sleeves).
- Portable delineators, placed at one-half the spacing indicated for traffic cones, may be used instead of cones for daytime closures only.
- Additional advance flaggers may be required. Flagger should stand in a conspicuous place, be visible to approaching traffic as well as approaching vehicles after the first vehicle has stopped. During the hours of darkness, the flagging station and flagger shall be illuminated and clearly visible to approaching traffic. The illumination footprint of the lighting on the ground shall be at least 20' in diameter. Place a minimum of four cones at 50' intervals in advance of flagger station as shown.
- Place C30(CA) "LANE CLOSED" sign at 500' to 1000' intervals throughout extended work areas. They are optional if the work area is visible from the flagger station.
- When a pilot car is used, place a C37(CA) "TRAFFIC CONTROL-WAIT AND FOLLOW PILOT CAR" sign with black legend on white background at all intersections, driveways and alleys without a flagger within traffic control area. Signs shall be clean and visible at all times. Where traffic can not be effectively self-regulated, at least one flagger shall be used at each intersection within traffic control area.
- An optional C29(CA) sign may be placed below the C9A(CA) sign.
- Either traffic cones or barricades shall be placed on the taper. Barricades shall be Type I, II, or III.
- The color of the portable transverse rumble strips shall be black or orange. Use 2 arrays, each array shall consist of 3 rumble strips.
- Portable transverse rumble strips shall not be placed on sharp horizontal or vertical curves nor shall they be placed through pedestrian crossings.
- If the portable transverse rumble strips become out of alignment (skewed) by more than 6 inches, measured from one end to the other, they shall be readjusted to bring the placement back to the original location.
- Portable transverse rumble strips are not required if any one of the following conditions is satisfied:
 - Work duration occupies a location for four hours or less
 - Posted speed limit is below 45 MPH
 - Work is of emergency nature
 - Work zone is in snow or icy weather conditions

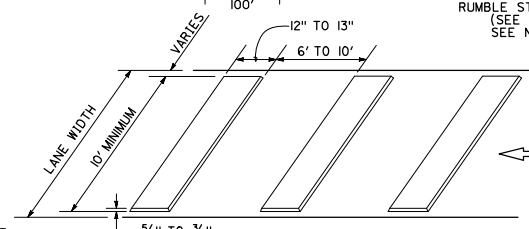

PORTABLE TRANSVERSE RUMBLE STRIP ARRAY DETAIL

SIGN PANEL SIZE (Min)

- A 48" x 48"
- B 30" x 30"
- C 36" x 18"
- D 36" x 42"
- E 20" x 7"

LEGEND

- TRAFFIC CONE
- † TEMPORARY TRAFFIC CONTROL SIGN
- ⚡ PORTABLE FLASHING BEACON
- 🚧 FLAGGER

STATE OF CALIFORNIA
DEPARTMENT OF TRANSPORTATION

TRAFFIC CONTROL SYSTEM FOR LANE CLOSURE ON TWO LANE CONVENTIONAL HIGHWAYS

NO SCALE

T13

254

2015 STANDARD PLAN T13

DIST	COUNTY	ROUTE	POST MILES TOTAL PROJECT	SHEET NO.	TOTAL SHEETS

Devinder Singh
REGISTERED CIVIL ENGINEER

October 30, 2015
PLANS APPROVAL DATE

Devinder Singh
REGISTERED PROFESSIONAL ENGINEER
No. C50470
Exp. 6-30-17
CIVIL
STATE OF CALIFORNIA

THE STATE OF CALIFORNIA OR ITS OFFICERS OR AGENTS SHALL NOT BE RESPONSIBLE FOR THE ACCURACY OR COMPLETENESS OF SCANNED COPIES OF THIS PLAN SHEET.

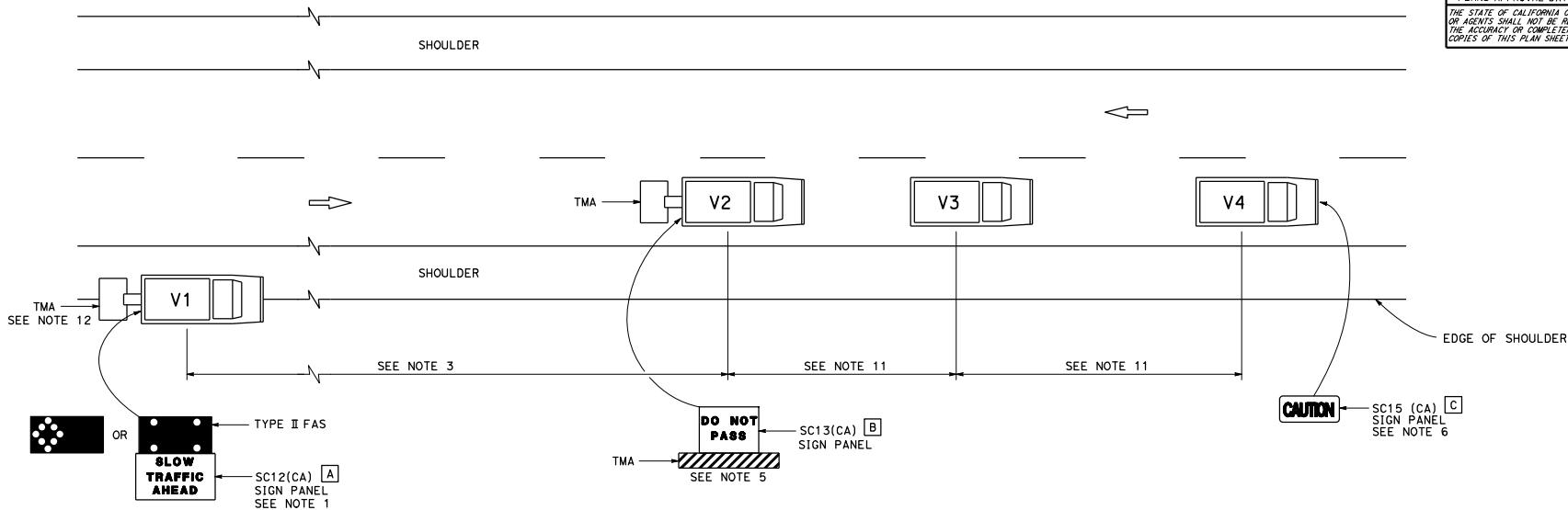

NOTES:

1. Either a changeable message sign or a SC12(CA) "SLOW TRAFFIC AHEAD" sign shall be mounted on the rear of sign vehicle V1. The changeable message sign shall be sequenced to show the "CAUTION" message first, follow by the "SLOW TRAFFIC AHEAD" message. A Type II flashing arrow sign may be used with the SC12(CA) sign panel.
2. Sign vehicle V1 should be positioned where highly visible when shoulders are not available.
3. If traffic queues develop, sign vehicle V1 should be positioned upstream from the end of queue.
4. Vehicle-mounted sign panels shall have Type III or above retroreflective sheeting, black on white, or black on fluorescent orange, with 6" minimum series D letters per Caltrans sign specifications.
5. Shadow vehicle shall be equipped with a truck-mounted attenuator. The sign panel shown shall be mounted on the rear of shadow vehicle V2. The message "LANE CLOSED" may be used in place of the "DO NOT PASS" message.
6. The sign panel shown shall be mounted on the front of sign vehicle V4, facing opposing traffic.

7. All vehicles shall be equipped with flashing or rotating amber lights.
8. Sign vehicle V4 will not be required when the work and vehicles V2 and V3 are 2' or more from the centerline of the highway during the work or application operations.
9. All vehicles used for lane closures shall be equipped with two-way radios and the vehicle operators shall maintain communication during the work or application operation.
10. This plan shall not be used where workers would be on foot in the work area. Use a stationary type lane closure (Standard Plan T13) for this condition.
11. Minimize spacing between vehicles V2 and V3 and vehicles V3 and V4 to deter road users from driving in between them.
12. If sign vehicle V1 encroaches into the traffic lane due to insufficient shoulder width, sign vehicle V1 shall be equipped with a truck-mounted attenuator. Sign vehicle V1 shall stay as close to the edge of shoulder as practicable.

LEGEND

- V1 SIGN VEHICLE
- V2 SHADOW VEHICLE
- V3 WORK/APPLICATION VEHICLE
- V4 SIGN VEHICLE
- TMA TRUCK-MOUNTED ATTENUATOR
- FLASHING ARROW SIGN (FAS) IN FLASHING CAUTION MODE
- FLASHING ARROW SIGN (FAS) IN ALTERNATING DIAMOND CAUTION

SIGN PANEL SIZE (Min)

- A 72" x 42"
- B 54" x 42"
- C 54" x 24"

STATE OF CALIFORNIA
DEPARTMENT OF TRANSPORTATION

**TRAFFIC CONTROL SYSTEM
FOR MOVING LANE CLOSURE
ON TWO LANE HIGHWAYS**

NO SCALE

T17

STATE OF CALIFORNIA • DEPARTMENT OF TRANSPORTATION
STANDARD ENCROACHMENT PERMIT APPLICATION
 TR-0100 (REV 12/2018)

Complete ALL fields, write "N/A" if not applicable. Type or print clearly.
 This application is not complete until all requirements have been approved.

Permission is requested to encroach on the State Highway right-of-way as follows:

1. COUNTY	2. ROUTE	3. POST MILE	FOR CALTRANS USE TRACKING NO. DIST/CO/RTE/PM SIMPLEX STAMP DATE OF SIMPLEX STAMP
4. ADDRESS OR STREET NAME	5. CITY		
6. CROSS STREET (Distance and direction from project site)			
7. WORK TO BE PERFORMED BY <input type="checkbox"/> APPLICANT <input type="checkbox"/> CONTRACTOR	8. IS THIS APPLICATION FOR THE CONTRACTOR'S (DOUBLE) PERMIT? <input type="checkbox"/> NO <input type="checkbox"/> YES. If "YES", provide the Parent Permit Number		
9. ESTIMATE START DATE	10. ESTIMATED COMPLETION DATE		
11. ESTIMATED NUMBER OF WORKING DAYS WITHIN STATE HIGHWAY RIGHT-OF-WAY			
12. ESTIMATED CONSTRUCTION COSTS WITHIN STATE HIGHWAY RIGHT-OF-WAY			
13. HAS THE PROJECT BEEN REVIEWED BY ANOTHER CALTRANS BRANCH? <input type="checkbox"/> NO <input type="checkbox"/> YES. If "YES", which branch?			
14. FUNDING SOURCE(S) <input type="checkbox"/> FEDERAL <input type="checkbox"/> STATE <input type="checkbox"/> LOCAL <input type="checkbox"/> PRIVATE <input type="checkbox"/> SB 1 (ROAD REPAIR AND ACCOUNTABILITY ACT OF 2017)			
15. CALTRANS PROJECT CODE (ID)		16. APPLICANT'S REFERENCE / UTILITY WORK ORDER NUMBER	
17. DESCRIBE WORK TO BE DONE WITHIN STATE HIGHWAY RIGHT-OF-WAY Attach 6 complete sets of plans (folded to 8.5" x 11") and any applicable specifications, calculations, maps, traffic control plans, etc.			

18 (a). PORTION OF STATE HIGHWAY RIGHT-OF-WAY WHERE WORK IS BEING PROPOSED (check all that apply)

Traffic lane
 Shoulder
 Sidewalk
 Median
 At or near an intersection
 Mobile work
 Outside of the shoulder, _____ feet from edge of pavement
 Other _____

18 (b). PROPOSED TRAFFIC CONTROL PLANS AND METHOD

No traffic control needed
 State Standard Plans (T-Sheets) # _____
 Project specific Traffic Control Plans included
 To be submitted by contractor

19. EXCAVATION	MAX. DEPTH (in)	MIN. DEPTH (in)	AVG. WIDTH (in)	LENGTH (ft)	SURFACE TYPE (e.g. Asphalt, concrete, soil, etc.)
20. PIPES	PRODUCT BEING TRANSPORTED		CARRIER PIPE DIAMETER ____ (in.) MATERIAL _____		CASING PIPE DIAMETER ____ (in.) MATERIAL _____
PROPOSED INSTALLATION METHOD (e.g. HDD, Bore & Jack, Open Cut, etc.)					VOLTAGE / PSIG

DOES THE PROPOSED PROJECT INVOLVE THE REPLACEMENT AND/OR ABANDONMENT OF AN EXISTING FACILITY?
 NO YES. If "YES", provide a description _____

21. IS A CITY, COUNTY OR OTHER PUBLIC AGENCY INVOLVED IN THE APPROVAL OF THIS PROJECT?

YES (if "YES", check the type of project AND attach the environmental documentation and conditions of approval)
 COMMERCIAL DEVELOPMENT
 BUILDING
 GRADING
 OTHER _____
 CATEGORICALLY EXEMPT
 NEGATIVE DECLARATION
 ENVIRONMENTAL IMPACT REPORT
 OTHER _____
 NO (if "NO", check the category below which best describes the project AND answer questions A-K on page 2)
 DRIVEWAY OR ROAD APPROACH, RECONSTRUCTION, MAINTENANCE OR RESURFACING
 FENCE
 EROSION CONTROL
 PUBLIC UTILITY MODIFICATION, EXTENSIONS, HOOKUPS
 MAILBOX
 LANDSCAPING
 FLAGS, SIGNS, BANNERS, DECORATIONS, PARADES AND CELEBRATIONS
 OTHER _____

The following questions must be answered when a City, County or other public agency IS NOT involved in the approval of this project.

Your answers to these questions will assist Caltrans staff in identifying any physical, biological, social or economic resources that may be affected by your proposed project within State Highway right-of-way and to determine which type of environmental studies may be required to approve your application for an encroachment permit. It is the applicant's responsibility for the production of all required environmental documentation and supporting studies and in some cases this may be costly and time consuming. If possible, attach photographs of the location of the proposed project. Answer these questions to the best of your ability. Provide a description of any "YES" answers (type, name, number, etc.).

A. Will any existing vegetation and/or landscaping within State Highway right-of-way be disturbed?

B. Are there waterways (e.g. river, creek, pond, natural pool or dry streambed) adjacent to or within the limits of the proposed project?

C. Is the proposed project located within five miles of the coast line?

D. Will the proposed project generate construction noise levels greater than 86 decibels (dBA) (e.g. Jack-hammering, pile driving)?

E. Will the proposed project incorporate land from a public park, recreation area or wildlife refuge open to the public?

F. Are there any recreational trails or paths within the limits of the proposed project?

G. Will the proposed project impact any structures, buildings, rail lines or bridges within State Highway right-of-way?

H. Will the proposed project impact access to any businesses or residences?

I. Will the proposed project impact any existing public utilities or public services?

J. Will the proposed project impact any existing pedestrian facilities, such as sidewalks, crosswalks or overcrossings?

K. Will new lighting be constructed within or adjacent to State Highway right-of-way?

22. Will the proposed project cause a substantial change in the significance of a historical resource (45 years or older), or cultural resource? YES NO (if "YES", provide a description)

23. Will the proposed project be on an existing State Highway or street where the activity involves removal of a scenic resource? (e.g. A significant tree or stand of trees, a rock outcropping or a historic building) YES NO (if "YES", provide a description)

24. Is work being done on the applicant's property in addition to State Highway right-of-way? YES NO
(If "YES", attach 6 complete sets of site and grading plans)

25. Will the proposed project require the disturbance of soil? YES NO
If "YES", estimate the area of disturbed soil within State Highway right-of-way in acres: _____
and estimate the area of disturbed soil outside State Highway right-of-way in acres: _____

26. Will the proposed project require dewatering? YES NO
If "YES", estimate Total gallons AND gallons/month. _____ (Total gallons) AND _____ (gallons/month)
SOURCE*: STORMWATER NON-STORMWATER
(*See Caltrans SWMP for definition of non-storm water discharge: <http://www.dot.ca.gov/env/stormwater/>)

27. How will any storm water or ground water be disposed?
 Storm Drain System Combined Sewer / Stormwater System Stormwater Retention Basin N/A
 Other (explain) _____

ADA Notice

For individuals with sensory disabilities, this document is available in alternate formats. For alternate format information, contact the Forms Management Unit at (916) 445-1233, TTY 711, or write to Records and Forms Management, 1120 N Street, MS-89, Sacramento, CA 95814.

TRACKING NO.

READ THE FOLLOWING CLAUSES PRIOR TO SIGNING THIS ENCROACHMENT PERMIT APPLICATION.

The applicant's submission of this application to the California Department of Transportation constitutes the applicant's agreement and representation that the work or other activity contemplated by the encroachment permit application shall comply with all applicable standards, specifications, policies, requirements, conditions, and regulations of the California Department of Transportation, and the applicant understands the application may be denied if there is non-compliance with any of the above. An exception process exists and may result in approval of a non-compliant encroachment, in the discretion of the California Department of Transportation, but the exception process may require additional time to complete. The applicant understands and agrees all work or other activity contemplated by the encroachment permit application is subject to inspection and oversight by the California Department of Transportation. The applicant understands and agrees encroachment permit fees must still be paid if an application is withdrawn or denied. The applicant understands a denial may be appealed, in accordance with California Streets and Highways Code, Section 671.5, and the related regulations found in California Code of Regulations, Title 21, Division 2, Chapter 8, Article 2.

The applicant understands and agrees that immediately upon issuance of the encroachment permit the applicant is bound by, subject to, and must comply with the "Encroachment Permit General Provisions" (TR-0045), "Stormwater Special Provisions" (TR-0400) and any other applicable Special Provisions and Conditions of the encroachment permit. The "Encroachment Permit General Provisions" (TR-0045), and the Stormwater Special Provisions (TR-0400) are available at: [http://www.dot.ca.gov/trafficops/ep/docs/Appendix_K_\(WEB\).pdf](http://www.dot.ca.gov/trafficops/ep/docs/Appendix_K_(WEB).pdf). If a paper copy is needed of the "Encroachment Permit General Provisions" (TR-0045) and/or "Stormwater Special Provisions" (TR-0400), please contact the District Office of Encroachment Permits. Their contact information is available at: [http://www.dot.ca.gov/trafficops/ep/docs/Appendix_G_\(WEB\).pdf](http://www.dot.ca.gov/trafficops/ep/docs/Appendix_G_(WEB).pdf). The "Encroachment Permit General Provisions" (TR-0045) and any other applicable Special Provisions and Conditions will be provided as part of the encroachment permit. Information about Stormwater requirements is available at the Internet address: <http://www.dot.ca.gov/hq/construc/stormwater/>.

The applicant understands an encroachment permit may be denied, revoked, and/or a bond may be required, for non-payment of prior or present encroachment permit fees. An encroachment permit is not a property right and does not transfer with the property to a new owner. Each of the persons purporting to execute this application on behalf of the applicant and/or on behalf of the applicant's authorized agent or engineer represents and warrants such person has full and complete legal authority to do so and to thereby bind applicant to the terms and conditions herein and to the terms and/or conditions of the encroachment permit. Applicant understands and agrees this application may be executed in one or more counterparts, each of which shall be deemed an original, but all of which together shall constitute one and the same instrument. Executed copies of this application and/or its counterparts may be reproduced and/or exchanged by copy machine, mailing, facsimile, or electronic means (such as e-mail), and such copies shall be deemed to be effective as originals.

28. NAME OF APPLICANT (Project or Property Owner or Organization)

ADDRESS OF APPLICANT (Include City, State and Zip Code)

E-MAIL ADDRESS	PHONE NUMBER	FAX NUMBER
----------------	--------------	------------

29. NAME OF AUTHORIZED AGENT / ENGINEER (A "Letter of Authorization" is required if different from #28)	IS A LETTER OF AUTHORIZATION ATTACHED? <input type="checkbox"/> YES <input type="checkbox"/> NO
--	--

ADDRESS OF AUTHORIZED AGENT / ENGINEER (Include City, State and Zip Code)

E-MAIL ADDRESS	PHONE NUMBER	FAX NUMBER
----------------	--------------	------------

30. NAME OF BILLING CONTACT (Same as #28 Same as #29)

BILLING ADDRESS WHERE INVOICE(S) IS / ARE TO BE MAILED (Include City, State and Zip Code)

E-MAIL ADDRESS	PHONE NUMBER	FAX NUMBER
----------------	--------------	------------

* I hereby certify under penalty of perjury under the laws of the State of California that the information in this application and any document submitted with or in support of this application are true and correct to the best of my knowledge and belief, and that copies of any documents submitted with or in support of this application are true and correct copies of unaltered original documents. I further understand that if I have provided information that is false, intentionally incomplete, or misleading I may be charged with a crime and subjected to fine or imprisonment, or both fine and imprisonment. (Penal Code Section 72)

31. SIGNATURE OF APPLICANT OR AUTHORIZED AGENT*	32. PRINT OR TYPE NAME
---	------------------------

33. TITLE	34. DATE
-----------	----------

INSTRUCTIONS

Complete ALL fields, write "N/A" if not applicable. Type or print clearly. All dimensions must be in U.S. Customary (English) units.

Print your application single sided and submit all of the required attachments (See Section VII A&B of the "Encroachment Permit Application Guide Booklet" found at: http://www.dot.ca.gov/trafficops/ep/docs/EP_Application_Guide_Booklet.pdf).

1. County (e.g. Fresno, San Francisco, Los Angeles, etc.)
2. State Highway Route Number (e.g. I-5, SR-99, etc.)
3. Highway Postmile: (location of work, see <https://postmile.dot.ca.gov/>)
If unable to determine, contact the appropriate District Encroachment Permits Office for assistance at: [http://www.dot.ca.gov/trafficops/ep/docs/Appendix_G_\(WEB\).pdf](http://www.dot.ca.gov/trafficops/ep/docs/Appendix_G_(WEB).pdf)
4. Address of project site (if the property has a physical address with a Number and Street/Road Name)
5. City (e.g. Sacramento, Redding, Irvine, etc.)
6. Distance and the direction from the nearest cross street to the project site (e.g. 500 ft. north of "C" Street).
7. Indicate whether the work will be performed by the applicant (your own forces) or by a contractor.
8. Indicate if you are applying for a "Contractor's (Double) Permit" and provide the "Parent Permit Number".
9. Estimated start date for the proposed work. (Allow a minimum of 60 calendar days from the submittal date of your application for processing)
10. Estimated completion date for the proposed work.
11. Estimated number of working days within State Highway right-of-way.
12. Estimated construction costs for all work to be done within State Highway right-of-way.
13. Has another Caltrans' branch seen or reviewed your project? Which branch? (e.g. Design, Project Management, Right-of-Way, Environmental, etc.)
14. Identify funding source(s) for the proposed work.
15. Caltrans' Project Code (ID) if this is a State project, capital project, or joint venture project.
16. Your company's reference number or utility work order number for this project.
17. Describe the proposed work to be done entirely. If applicable, attach six (6) complete sets of FOLDED plans (folded 8-1/2" X 11") and any applicable specifications, calculations, maps, etc.
18. (a) Identify portion(s) of State right-of-way where work will occur and (b) proposed traffic control plans to be used if any.
19. Maximum and minimum depth, average width, and length of the excavation area. Existing surface type (e.g. Asphalt, concrete, soil, etc.)
20. Product being transported (e.g. water, natural gas, etc.)
Carrier pipe, diameter (inches) and material (e.g. Steel, HDPE, etc.)
Casing pipe (if any), diameter and material Proposed installation method, Voltage of electrical current or pressure of liquid or gas.
21. Check "YES", if you are getting a permit or approval from another agency (City, County, etc.), and an environmental determination has been made. Then check the Categorically Exempt, Negative Declaration, Environmental Impact Report box or Other if one has been prepared. Attach a copy of the approved document and a copy of the Notice of Determination. Skip questions A-K on page 2 of the application.

If you checked "NO", check the box of the appropriate type of work to be done, or check "other" and fill in the type of work to be done. Also answer questions A-K on page 2 of the application.
22. A Historical Resource includes, but is not limited to, any object, building, structure, site, area, place, record, or manuscript that has historical or archaeological significance, or significance in the architectural, engineering, scientific, economic, agricultural, educational, social, political, military, or cultural annals of California.
23. In this context a Scenic Resource includes, but is not limited to, trees that display outstanding features of form or age; unique, massive rock formations; historic buildings that are rare examples of their period, style, design, or which have special architectural features and details of importance.
24. Is there any work being done on the applicant's property?
25. Indicate if the proposed project will require the disturbance of soil. If "YES," estimate the area within AND outside of State Highway right-of-way in acres.
26. Indicate if the proposed project will require dewatering. If "YES," estimate volume in total gallons AND gallons per month. Also indicate the source: Stormwater or Non-Stormwater (see Caltrans Stormwater Management Plan for definitions of non-stormwater discharge at: <http://www.dot.ca.gov/hq/env/stormwater/>).
27. Indicate how any stormwater or ground water will be disposed of from or near the limits of the proposed project.
28. Name of the applicant or organization applying for the permit. List the mailing address, e-mail address, phone and fax numbers.
29. Name of the authorized agent or engineer acting on behalf of the applicant or organization. Attach a letter of authorization signed by the applicant or organization. List the mailing address, e-mail address, phone and fax numbers.
30. Name of the billing contact. List the mailing address where invoices are to be mailed, email address, phone and fax numbers.
31. Signature of the applicant or applicant's authorized agent.
32. Name of the applicant or applicant's authorized agent.
33. Title (owner, president, etc.) of the applicant or applicant's authorized agent.
34. Date of the signature.

APPLICATION FOR ENCROACHMENT PERMIT

COUNTY OF TULARE
RESOURCE MANAGEMENT AGENCY
5961 S. MOONEY BLVD.
VISALIA, CA 93277
(559) 624-7000

ANY REQUIREMENTS OR REGULATIONS YOU FEEL UNJUST MAY BE APPEALED TO THE COUNTY BOARD OF SUPERVISORS. THE CONTRACTOR AND APPLICANT UNDERSTAND THAT THIS IS AN APPLICATION ONLY, NOT A PERMIT. NO WORK SHALL START UNTIL A PERMIT IS ISSUED AND THE PERMIT IS ON THE JOB SITE.

The undersigned hereby applies for a permit to allow them to do certain work within the right-of-way of a County Highway, in accordance with Sections 3-07-1160 to 3-07-1385 of the Ordinance Code of Tulare County. The necessary information concerning said work is as follows:

1. LOCATION and DESCRIPTION of the proposed work to be done within right-of-way.

A. General location described by number or name of highway.

Road _____ From Avenue _____ To Avenue _____
Avenue _____ From Road _____ To Road _____
Other _____ From _____ To _____

B. Description of exact location in feet of encroachment from the County property line or section line and edge of pavement, starting from the nearest cross road property line. (If more room is needed attach a sheet).

Example: Install 6" steel Water main on Road 100 starting 1510' south of the Center Line of Ave. 100, at 25' east of the center line or section line of Road 100, and 5' east of the edge of oil, then south for 350', then east 5' to private property.

INSTALL:

Blank lines for installation details.

2. ATTACH TWO (2) SETS OF PLANS showing road right-of-way, edge of pavement from property line. The exact location of proposed work, all County drain pipes, roads, avenues, type of driveways, bridges (need blowup), footage of encroachment for each road and all existing utilities.

3. TYPE OF WORK to be done. (check one)

Sewer [] Water [] Elec. Service [] A.C. Driveway [] Pipeline []
TV Cable [] Other _____

4. PURPOSE OF THE PROPOSED WORK. (check one)

New Main [] Replacement [] New Service [] Other _____

5. Will pavement be cut or disturbed.

Yes [] No [] Bore [] Open Trench []

6. The materials which will be used to perform this work are as follows.

Plastic Pipe [] Steel Pipe [] Cable [] Concrete Pipe [] Other _____
Size _____ Size _____ Size _____ Size _____ Size _____
Type _____ Type _____ Type _____ Type _____ Type _____
SDR Rating _____

7. The proposed work will be commenced on or about _____

To be completed on or about _____

8. Other pertinent information, including additional information required by the Resource Management Agency (RMA).

IF ADDITIONAL SPACE IS REQUIRED FOR FURNISHING ANY OF THE INFORMATION REQUIRED, PUT THE INFORMATION ON A SEPARATE SHEET OF PAPER AND ATTACH IT TO THIS APPLICATION.

The applicant agrees that the aforementioned work is subject to, and will be performed in accordance with all of the provisions of Sections 3-07-1160 to 3-07-1385 of the Ordinance Code of Tulare County. The applicant agrees to hold the County, its officers, agents and employees harmless from any and all causes of action, penalties, liabilities or loss resulting from claims or court actions arising out of any accidents, loss or damage to persons or property occurring as a result of any work performed pursuant to the permit.

The applicant agrees that the County shall not be responsible for any damage to any structure or installation constructed pursuant to a permit which is not clearly or visibly marked by the construction, reconstruction, maintenance or repair or by use of overweight equipment on the highway. The applicant agrees that he, his successors and assigns, upon being notified of such damage by the Resource

Management Agency Director or designee, shall immediately repair, remove or relocate the damaged structure or installation.

9. As required by sections 3-07-1195 to 3-07-1215 of the Ordinance Code of Tulare County, the following insurance policy and bond are furnished covering said work.

BOND (Min. \$5,000 to Max. \$25,000 determined by R.M.A.) (check one) INSURANCE POLICY (check one)

On file with R.M.A.

On file with R.M.A.

Enclosed

Enclosed

Bond Amount \$ _____

10. APPROVAL OF SERVING PUBLIC UTILITY, PUBLIC AGENCY, OR COMMUNITY SERVICES DISTRICT FOR UTILITY, SEWER OR WATER CONNECTIONS:

Name of Serving Utility	Phone number	Signature	Date
<u>CONTRACTOR</u>		<u>APPLICANT (PROPERTY OWNER)</u>	
Company Name _____		Name _____	
Address: _____		Address: _____	
City: _____ Zip Code: _____		City: _____ Zip Code: _____	
Signature: _____		Signature: _____	
Phone No (____) _____		Phone No (____) _____	
Date: _____		Date: _____	
Email: _____		Email: _____	

FOR COUNTY USE ONLY

Application Received _____	Field Review _____ By _____
Insurance expires _____	Office Check _____ By _____
Bond expires _____	OK for Permit _____ By _____

Returned _____ for _____ correction _____

Notes to be added to Permits _____

SELF-DEALING TRANSACTION DISCLOSURE FORM

(1) Company Board Member Information:

Name: _____ Date: _____

Job Title: _____

(2) Company/Agency Name and Address:

(3) Disclosure (Please describe the nature of the self-dealing transaction you are a party to)

(4) Explain why this self-dealing transaction is consistent with the requirements of Corporations Code 5233 (a)

(5) Authorized Signature

Signature: _____ Date: _____

SELF-DEALING TRANSACTION DISCLOSURE FORM INSTRUCTIONS

In order to conduct business with the County of Fresno (hereinafter referred to as "County"), members of a contractor's board of directors (hereinafter referred to as "County Contractor"), must disclose any self-dealing transactions that they are a party to while providing goods, performing services, or both for the County. A self-dealing transaction is defined below:

"A self-dealing transaction means a transaction to which the corporation is a party and which one or more of its directors has a material financial interest"

The definition above will be utilized for purposes of completing the disclosure form.

- (1) Enter board member's name, job title (if applicable), and date this disclosure is being made.
- (2) Enter the board member's company/agency name and address.
- (3) Describe in detail the nature of the self-dealing transaction that is being disclosed to the County. At a minimum, include a description of the following:
 - a. The name of the agency/company with which the corporation has the transaction; and
 - b. The nature of the material financial interest in the Corporation's transaction that the board member has.
- (4) Describe in detail why the self-dealing transaction is appropriate based on applicable provisions of the Corporations Codes.
- (5) Form must be signed by the board member that is involved in the self-dealing transaction described in Sections (3) and (4).

expression, age, sexual orientation, or military and veteran status. Contractor shall insure that the evaluation and treatment of employees and applicants for employment are free of such discrimination.

2. Contractor shall comply with the provisions of the Fair Employment and Housing Act (Gov. Code, § 12900 et seq.), the regulations promulgated thereunder (Cal. Code Regs., tit. 2, § 11000 et seq.), the provisions of Article 9.5, Chapter 1, Part 1, Division 3, Title 2 of the Government Code (Gov. Code, §§ 11135-11139.5), and the regulations or standards adopted by the awarding state agency to implement such article.
3. Contractor or recipient shall permit access by representatives of the Department of Fair Employment and Housing and the awarding state agency upon reasonable notice at any time during the normal business hours, but in no case less than 24 hours' notice, to such of its books, records, accounts, and all other sources of information and its facilities as said Department or Agency shall require to ascertain compliance with this clause.
4. Recipient, contractor and its subcontractors shall give written notice of their obligations under this clause to labor organizations with which they have a collective bargaining or other agreement.
5. The contractor shall include the nondiscrimination and compliance provisions of this clause in all subcontracts to perform work under the contract.

Under 2 CA Code of Regs § 11122:

STANDARD CALIFORNIA NONDISCRIMINATION CONSTRUCTION CONTRACT SPECIFICATIONS (GOV. CODE SECTION 12990)

These specifications are applicable to all state contractors and subcontractors having a construction contract or subcontract of \$5,000 or more.

1. As used in the specifications:
 - a. "Act" means the Fair Employment and Housing Act.
 - b. "Administrator" means Administrator, Office of Compliance Programs, California Department of Fair Employment and Housing, or any person to whom the Administrator delegates authority;
2. Whenever the contractor or any subcontractor subcontracts a portion of the work, it shall include in each subcontract of \$5,000 or more the nondiscrimination clause in this contract directly or through incorporation by reference. Any subcontract for work involving a construction trade shall also include the Standard California Construction Contract Specifications, either directly or through incorporation by reference.
3. The contractor shall implement the specific nondiscrimination standards provided in paragraphs 6(a) through (e) of these specifications.
4. Neither the provisions of any collective bargaining agreement, nor the failure by a union with whom the contractor has a collective bargaining agreement, to refer members of any group protected by the Act shall excuse the contractor's obligations under these specifications, Government Code section 12990, or the regulations promulgated pursuant thereto.5. In order for the nonworking training hours of apprentices and trainees to be counted, such apprentices and trainees must be employed by the contractor during the training period, and the contractor must have made a commitment to employ the apprentices and trainees at the completion of their training, subject to the availability of employment opportunities. Trainees must be trained pursuant to training programs approved by the U.S. Department of Labor or the California Department of Industrial Relations.
5. In order for the nonworking training hours of apprentices and trainees to be counted, such apprentices and trainees must be employed by the contractor during the training period, and the contractor must have made a commitment to employ the apprentices and trainees at the completion of their training, subject to the availability of employment opportunities. Trainees must be trained pursuant to training programs approved by the U.S. Department of Labor or the California Department of Industrial Relations.
6. The contractor shall take specific actions to implement its nondiscrimination program. The evaluation of the contractor's compliance with these specifications shall be based upon its effort to achieve maximum results from its actions. The contractor must be able to demonstrate fully its efforts under steps a. through e. below:
 - a. Ensure and maintain a working environment free of harassment, intimidation, and coercion at all sites, and at all facilities at which the contractor's employees are assigned to work. The contractor shall specifically ensure that all foremen, superintendents, and other on-site

- supervisory personnel are aware of and carry out the contractor's obligations to maintain such a working environment.
- b. Provide written notification within seven days to the director of the DFEH when the referral process of the union or unions with which the contractor has a collective bargaining agreement has impeded the contractor's efforts to meet its obligations.
 - c. Disseminate the contractor's equal employment opportunity policy by providing notice of the policy to unions and training, recruitment and outreach programs and requesting their cooperation in assisting the contractor to meet its obligations; and by posting the company policy on bulletin boards accessible to all employees at each location where construction work is performed.
 - d. Ensure all personnel making management and employment decisions regarding hiring, assignment, layoff, termination, conditions of work, training, rates of pay or other employment decisions, including all supervisory personnel, superintendents, general foremen, on-site foremen, etc., are aware of the contractor's equal employment opportunity policy and obligations, and discharge their responsibilities accordingly.
 - e. Ensure that seniority practices, job classifications, work assignments, and other personnel practices, do not have a discriminatory effect by continually monitoring all personnel and employment related activities to ensure that the equal employment opportunity policy and the contractor's obligations under these specifications are being carried out.
7. Contractors are encouraged to participate in voluntary associations that assist in fulfilling their equal employment opportunity obligations. The efforts of a contractor association, joint contractor-union, contractor-community, or other similar group of which the contractor is a member and participant, may be asserted as fulfilling any one or more of its obligations under these specifications provided that the contractor actively participates in the group, makes every effort to assure that the group has a positive impact on equal employment opportunity in the industry, ensures that the concrete benefits of the program are reflected in the contractor's workforce participation, and can provide access to documentation that demonstrates the effectiveness of actions taken on behalf of the contractor. The obligation to comply, however, is the contractor's.
 8. The contractor is required to provide equal employment opportunity for all persons. Consequently, the contractor may be in violation of the Fair Employment and Housing Act (Government Code section 12990 et seq.) if a particular group is employed in a substantially disparate manner.
 9. The contractor shall not use the nondiscrimination standards to discriminate against any person because race, religious creed, color, national origin, ancestry, physical disability, mental disability, medical condition, genetic information, marital status, sex, gender, gender identity, gender expression, age, sexual orientation, or military and veteran status.
 10. The contractor shall not enter into any subcontract with any person or firm decertified from state contracts pursuant to Government Code section 12990.
 11. The contractor shall carry out such sanctions and penalties for violation of these specifications and the nondiscrimination clause, including suspension, termination and cancellation of existing subcontracts as may be imposed or ordered pursuant to Government Code section 12990 and its implementing regulations by the awarding agency. Any contractor who fails to carry out such sanctions and penalties shall be in violation of these specifications and Government Code section 12990.
 12. The contractor shall designate a responsible official to monitor all employment related activity to ensure that the company equal employment opportunity policy is being carried out, to submit reports relating to the provisions hereof as may be required by OCP and to keep records. Records shall at least include for each employee the name, address, telephone numbers, construction trade, union affiliation if any, employee identification number when assigned, status, (e.g., mechanic, apprentice trainee, helper, or laborer), dates of changes in status, hours worked per week in the indicated trade, rate of pay, and locations at which the work was performed. Records shall be maintained in any easily understandable and retrievable form; however, to the degree that existing records satisfy this requirement, contractors shall not be required to maintain separate records.

Add to the end of the 2nd sentence in the 1st paragraph of section 7-1.02K(1):

, and hauling and delivery of ready-mixed concrete.

04-22-16

Add between the 4th and 5th paragraphs of section 7-1.02K(3):

04-22-16

Submitted certified payrolls for hauling and delivering ready-mixed concrete must be accompanied by a written time record. The time record must include:

1. Truck driver's full name and address
2. Name and address of the factory or batching plant
3. Time the concrete was loaded at the factory or batching plant
4. Time the truck returned to the factory or batching plant
5. Truck driver's signature certifying under penalty of perjury that the information contained in this written time record is true and correct

Add between the 9th and 10th paragraphs of section 7-1.03:

07-15-16

If a height differential of more than 0.04 foot is created by construction activities at a joint transverse to the direction of traffic on the traveled way or a shoulder subject to public traffic, construct a temporary taper at the joint with a slope complying with the requirements shown in the following table:

Temporary Tapers

Height differential (foot)	Slope (horizontal:vertical)	
	Taper use of 14 days or less	Taper use of more than 14 days
Greater than 0.08	100:1 or flatter	200:1 or flatter
0.04–0.08	70:1 or flatter	70:1 or flatter

For a taper on existing asphalt concrete or concrete pavement, construct the taper with minor HMA under section 39-2.07.

Grind existing surfaces to accommodate a minimum taper thickness of 0.10 foot under either of the following conditions:

1. HMA material such as rubberized HMA, polymer-modified bonded wearing course, or open-graded friction course is unsuitable for raking to a maximum 0.02 foot thickness at the edge
2. Taper will be in place for more than 14 days

For a taper on a bridge deck or approach slab, construct the taper with polyester concrete under section 60-3.04B.

The completed surface of the taper must be uniform and must not vary more than 0.02 foot from the lower edge of a 12-foot straightedge when placed on its surface parallel and perpendicular to traffic.

If authorized, you may use alternative materials or methods to construct the required taper.

Replace § 337.15 in the 3rd item in the list in the paragraph of section 7-1.06B with:

05-06-16

§ 337.1

Add between the 1st and 2nd paragraphs of section 7-1.11A:

02-12-16

Comply with 46 CFR 381.7(a)–(b).

AA

8 PROSECUTION AND PROGRESS

07-15-16

Replace the table in the 3rd paragraph of section 8-1.10A with:

07-15-16

Liquidated Damages

Total bid		Liquidated damages per day
From over	To	
\$0	\$60,000	\$1,400
\$60,000	\$200,000	\$2,900
\$200,000	\$500,000	\$3,200
\$500,000	\$1,000,000	\$3,500
\$1,000,000	\$2,000,000	\$4,000
\$2,000,000	\$5,000,000	\$4,800
\$5,000,000	\$10,000,000	\$6,800
\$10,000,000	\$20,000,000	\$10,000
\$20,000,000	\$50,000,000	\$13,500
\$50,000,000	\$100,000,000	\$19,200
\$100,000,000	\$250,000,000	\$25,300

^^

9 PAYMENT

01-15-16

Replace *may withhold* in the 1st paragraph of section 9-1.16E(4) with:

01-15-16

withholds

^^

DIVISION II GENERAL CONSTRUCTION

10 GENERAL

04-15-16

Replace section 10-1.02B with:

04-15-16

10-1.02B Traffic Elements

Before starting the operational test of a traffic management system that directly impacts traffic, the system must be ready for operation, and all signs, pavement delineation, and pavement markings must be in place at the system's location.

If maintaining existing traffic management system elements during construction is shown on the Bid Item List, a list of the systems shown within the project limits and their operational status is included in the *Information Handout*. Before starting job site activities, conduct a preconstruction operational status check of the existing system's elements and each element's communication status with the transportation management center to which it communicates. If an existing system element is discovered and has not been identified, the Department adds the element to the list of systems. The pre- and postconstruction operational status check of the discovered elements is change order work.

If maintaining existing traffic management system elements during construction is not shown on the Bid Item List and an existing system element is discovered during the work, notify the Engineer. The Engineer orders a pre- and postconstruction operational status check of the discovered elements. The status check of the discovered elements is change order work.

To prevent encroachment onto the traveled way where the useable shoulder area is less than 15 feet wide, you may use a smaller message panel with at least 12-inch-high characters.

The message displayed on the sign must be visible from a distance of 1,500 feet and legible from a distance of 750 feet at noon on a cloudless day and during the night by persons with 20/20 vision or vision corrected to 20/20.

The characters on a sign panel may be 10 inches in height if:

1. PCMS is mounted on a service patrol truck or other incident response vehicle or used for traffic control operations on a highway facility where the posted speed limit is less than 40 mph
2. Message is legible from a distance of at least 650 feet at noon on a cloudless day and during the night by persons with 20/20 vision or vision corrected to 20/20

A matrix sign must provide a complete alphanumeric selection.

A PCMS must automatically adjust its brightness under varying light conditions to maintain the legibility of the message. The sign must be equipped with an automatic-dimming mode that automatically compensates for the influence of temporary light sources or abnormal lighting conditions. The sign must have 3 or more manual dimming modes of different intensities.

During the hours of darkness, a matrix sign not using lamps must be either internally or externally illuminated.

The controller must be an all solid-state unit containing the necessary circuitry for the storage of at least 5 preprogrammed messages. The controller must be installed at a location that allows the operator to perform all functions from a single position. The controller must have a keyboard entry system that allows the operator to generate an infinite number of additional messages in addition to the preprogrammed stored messages. The keyboard must be equipped with a security lockout feature to prevent unauthorized use of the controller.

The controller must have:

1. Nonvolatile memory that stores keyboard-created messages during periods when the power is not activated
2. Variable display rate that allows the operator to match the information display to the speed of approaching traffic
3. Screen upon which messages may be reviewed before being displayed on the sign

The flashing-off time must be adjustable from within the control cabinet.

12-3.32C Construction

Place a PCMS as far from the traveled way as practicable where it is legible to approaching traffic without encroaching on the traveled way. Where the vertical roadway curvature restricts the sight distance of approaching traffic, place the sign on or before the crest of the curvature where it is most visible to the approaching traffic. Where the horizontal roadway curvature restricts the sight distance of approaching traffic, place the sign at or before the curve where it is most visible to approaching traffic. Where practicable, place the sign behind guardrail or Type K temporary railing.

Make a taper consisting of 9 traffic cones placed 25 feet apart to delineate the location of a PCMS except where the sign is placed behind guardrail or Type K temporary railing.

When in full operation, the bottom of a sign must be at least 7 feet above the roadway in areas where pedestrians are anticipated and 5 feet above the roadway elsewhere, and the top of the sign must be not more than 14.5 feet above the roadway.

Operate the PCMS under the manufacturer's instructions.

Keep the PCMS clean to provide maximum visibility.

If multiple signs are needed, place each sign on the same side of the road at least 1,000 feet apart on freeways and expressways and at least 500 feet apart on other types of highways.

If more than one PCMS is simultaneously visible to traffic, only 1 sign may display a sequential message at any time. Do not use dynamic message displays, such as animation, rapid flashing, dissolving, exploding, scrolling, horizontal movement, or vertical movement of messages. The message must be centered within each line of the display.

You may use an additional PCMS if more than 2 phases are needed to display a message.

Display only messages shown or ordered.

Repeat the entire message continuously in not more than 2 phases of at least 3 seconds per phase. The sum of the display times for both of the phases must be a maximum of 8 seconds. If more than 2 phases are needed to display a message, use an additional PCMS.

You must be available by cell phone during activities that require a sign. Be prepared to immediately change the displayed message if ordered. You may operate the sign with a 24-hour timer control or remote control if authorized.

After the initial placement, move a sign from location to location as ordered.

When a PCMS is not in use, move it to an area at least 15 feet from the edge of the traveled way or remove it from the job site away from traffic.

12-3.32D Payment

Not Used

Add between the 1st sentence and 2nd sentences in the 1st paragraph of section 12-4.02A(3)(a):

07-15-16

For a project in District 7, submit the request at least 15 days before the proposed closure date.

Replace section 12-4.02C(2) with:

01-15-16

12-4.02C(2) Lane Closure System

12-4.02C(2)(a) General

The Department provides LCS training. Request the LCS training at least 30 days before submitting the 1st closure request. The Department provides the training within 15 days after your request.

LCS training is web-based or held at a time and location agreed upon by you and the Engineer. For web-based training, the Engineer provides you the website address to access the training.

With 5 business days after completion of the training, the Department provides LCS accounts and user IDs to your assigned, trained representatives.

Each representative must maintain a unique password and current user information in the LCS.

04-15-16

The project is not accessible in LCS after Contract acceptance.

01-15-16

12-4.02C(2)(b) Status Updates for Authorized Closures

Update the status of authorized closures using the LCS Mobile web page.

For a stationary closure, use code:

1. 10-97 immediately before you place the 1st advance warning sign
2. 10-98 immediately after you remove all of the advance warning signs

For a moving closure, use code:

1. 10-97 immediately before the actual start time of the closure
2. 10-98 immediately after the actual end time of the closure

Cancel an authorized closure by using code 10-22 within 2 hours after the authorized start time.

If you are unable to access the LCS Mobile web page, immediately notify the Engineer of the closure's status.

Replace the 1st sentence in the 3rd paragraph of section 12-6.03A with:

07-15-16

When the Engineer determines the temporary pavement delineation is no longer required for the direction of traffic, remove the temporary pavement delineation, including any underlying adhesive for temporary pavement markers, from the final layer of surfacing and from the pavement to remain in place.

^^

13 WATER POLLUTION CONTROL

09-02-16

Replace *General Industrial Permit* in the 2nd item in the list in the paragraph of section 13-1.01C(3) with:

05-06-16

Industrial General Permit

Replace the 2nd paragraph of section 13-1.01D(2) with:

05-06-16

Discharges from manufacturing facilities, such as batch plants and crushing plants, must comply with the discharge requirements in the NPDES General Permit for Storm Water Discharges Associated with Industrial Activities; Order No. 2014-0057-DWQ, CAS000001 (Industrial General Permit), issued by the SWRCB. For the Industrial General Permit, go to the SWRCB website.

Replace *General Industrial Permit* in the 3rd paragraph of section 13-1.01D(2) with:

05-06-16

Industrial General Permit

Replace the 2nd paragraph of section 13-3.01D(2) with:

09-02-16

For a project in the Lake Tahoe Hydrologic Unit, discharges of stormwater from the project must comply with the NPDES General Permit for General Waste Discharge Requirements and National Pollutant Discharge Elimination System General Permit for Storm Water Discharges Associated with Construction Activity in the Lake Tahoe Hydrologic Unit, Counties of Alpine, El Dorado, and Placer, (Order No. R6T-2016-0010 and NPDES No. CAG616002). You may view the General Permit for the Lake Tahoe Hydrologic Unit at the Construction Storm Water Program page of the SWRCB website.

Replace the 2nd paragraph of section 13-8.01D(2) with:

09-02-16

For a project within the Lake Tahoe Hydrologic Unit, the design, installation, operation, and monitoring of the temporary ATS and monitoring of the treated effluent must comply with Attachment E of the NPDES General Permit for General Waste Discharge Requirements and National Pollutant Discharge Elimination System General Permit for Storm Water Discharges Associated with Construction Activity in the Lake Tahoe Hydrologic Unit, Counties of Alpine, El Dorado, and Placer, (Order No. R6T-2016-0010 and NPDES No. CAG616002). You may view the General Permit for the Lake Tahoe Hydrologic Unit at the Construction Storm Water Program page of the SWRCB website.

AA

16 TEMPORARY FACILITIES

04-15-16

Add between the 1st and 2nd sentences of section 16-2.03A(1):

04-15-16

Constructing a high-visibility fence includes the installation of any signs specified in the special provisions.

AA

DIVISION III EARTHWORK AND LANDSCAPE

20 LANDSCAPE

07-15-16

Replace 86 in the 1st paragraph of section 20-2.01C(2) with:

04-15-16

87

Replace the 8th paragraph of section 20-2.01C(2) with:

07-15-16

Trenches for irrigation supply lines and conduits 3 inches and larger in diameter must be a minimum of 18 inches below the finished grade, measured to the top of the installed pipe.

Replace 86 in the 1st paragraph of section 20-2.01C(3) with:

04-15-16

87

Replace section 20-2.04A(4) with:

04-15-16

Perform conductors test. The test must comply with the specifications in section 87.

Where the conductors are installed by trenching and backfilling, perform the test after a minimum of 6 inches of backfill material has been placed and compacted over the conductors.

Replace the 1st paragraph of section 20-2.04C(4) with:

04-15-16

Splice low voltage control and neutral conductors under section 87, except do not use Method B.

Replace the 3rd paragraph of section 20-2.05B with:

07-15-16

The impeller must be glass reinforced nylon on a tungsten carbide shaft.

Replace 86 in the 2nd paragraph of section 20-2.06C with:

04-15-16

87

Replace section 20-2.07B(5) with:

04-15-16

20-2.07B(5) PVC Pipe Conduit Sleeve

PVC pipe conduit sleeves must be schedule 40 complying with ASTM D1785.

Fittings must be schedule 80.

Replace section 20-2.07C(3) with:

04-15-16

20-2.07C(3) PVC Pipe Conduit Sleeve

Where PVC pipe conduit sleeves 2 inches or less in outside diameter is installed under surfacing, you may install by directional boring under section 20-2.07C(2)(b).

For sleeves 2 inches or less in diameter, the top of the conduit must be a minimum of 18 inches below surfacing.

Extend sleeves 6 inches beyond surfacing. Cap ends of conduit until used.

Replace sections 20-2.09B and 20-2.09C with:

07-15-16

20-2.09B Materials

20-2.09B(1) General

Swing joints must match the inlet connection size of the riser.

Where shown, a sprinkler assembly must include a check valve.

Threaded nipples for swing joints and risers must be schedule 80, PVC 1120 or PVC 1220 pipe, and comply with ASTM D1785. Risers for sprinkler assemblies must be UV resistant.

Fittings for sprinkler assemblies must be injection-molded PVC, schedule 40, and comply with ASTM D2466.

Flexible hose for sprinkler assemblies must be leak-free, non-rigid and comply with ASTM D2287, cell Type 6564500. The hose must comply with ASTM D2122 and have the thickness shown in the following table:

Nominal hose diameter (inch)	Minimum wall thickness (inch)
1/2	0.127
3/4	0.154
1	0.179

Solvent cement and fittings for flexible hose must comply with section 20-2.08B(5).

20-2.09B(2) Pop-Up Sprinkler Assemblies

Each pop-up sprinkler assembly must include a body, nozzle, swing joint, pressure reducing device, fittings, and sprinkler protector where shown.

20-2.09B(3) Riser Sprinkler Assemblies

Each riser sprinkler assembly must include a body, flexible hose, threaded nipple, nozzle, swing joint (except for a Type V riser), pressure reducing device, fittings, and riser support where shown.

20-2.09B(4) Tree Well Sprinkler Assemblies

Each tree well sprinkler assembly must include a threaded nipple, nozzle, swing joint, fittings, perforated drainpipe, and drain grate.

The perforated drainpipe must be commercial-grade, rigid PVC pipe with holes spaced not more than 6 inches on center on 1 side of the pipe.

The drain grate must be a commercially-available, 1-piece, injection-molded grate manufactured from structural foam polyolefins with UV light inhibitors. Drain grate must be black.

Gravel for filling the drainpipe must be graded such that 100 percent passes the 3/4-inch sieve and 100 percent is retained on the 1/2-inch sieve. The gravel must be clean, washed, dry, and free from clay or organic material.

20-2.09C Construction

Where shown, install a flow shut-off device under the manufacturer's instructions, unless you use equipment with a preinstalled flow shut-off device.

Where shown, install a pressure reducing device under the manufacturer's instructions, unless you use equipment with a preinstalled pressure reducing device.

Install pop-up and riser sprinkler assembly:

1. From 6-1/2 to 8 feet from curbs, dikes, and sidewalks
2. At least 10 feet from paved shoulders
3. At least 3 feet from fences and walls

If sprinkler assembly cannot be installed within these limits, the location will be determined by the Engineer.

Set sprinkler assembly riser on slopes perpendicular to the plane of the slope.

Replace the paragraph of section 20-2.10B(3) with:

07-15-16

Each check valve must be one of the following:

1. Schedule 80 PVC with a factory setting to withstand a minimum 7-foot head on risers
2. Class 200 PVC if used on a nonpressurized plastic irrigation supply line
3. Internal to the sprinkler body with a factory setting to withstand a minimum 7-foot head

Replace the paragraph of section 20-2.10C(3) with:

07-15-16

Install check valves as necessary to prevent low-head drainage.

Replace the paragraphs of section 20-3.01B(10) with:

07-15-16

Each plant stake for vines must be nominal 1 by 1 inch and 18 inches long.

Each plant stake for trees must be nominal 2 by 2 inches or nominal 2 inches in diameter and long enough to keep the tree in an upright position.

Replace the paragraph of section 20-3.01B(11) with:

07-15-16

Each plant tie for vines must be extruded vinyl-based tape, 1 inch wide and at least 8 mils thick.

Each plant tie for trees must be a (1) minimum 3/4-inch-wide, UV-resistant, flexible vinyl tie complying with ASTM D412 for tensile and elongation strength, or (2) lock-stitch, woven polypropylene with a minimum 900 lb tensile strength.

Add between the 7th and 8th paragraphs of section 20-3.02C(3)(b):

07-15-16

Spread the vine shoots and tie them with a plant tie to each stake above the crossing point.

Replace the 8th paragraph of section 20-3.02C(3)(b) with:

07-15-16

Tie trees to the stakes with 2 tree ties, 1 tie to each stake. Each tie must form a figure eight by crossing the tie between the tree and the stake. Install ties at the lowest position that will support the tree in an upright position. Install the ties such that they provide trunk flexibility but do not allow the trunk to rub against the stakes. Wrap each end of the tie 1-1/2 turns around the stake and securely tie or nail it to the stake.

Replace the 1st paragraph of section 20-5.02C(1) with:

07-15-16

Where edging is used to delineate the limits of inert ground cover or wood mulch areas, install the edging before installing the inert ground cover or wood mulch.

Delete *AND MULCHES* in the heading of section 20-5.03.

07-15-16

Delete *and mulches* in the paragraph of section 20-5.03A(1)(a).

07-15-16

Replace the paragraph of section 20-5.03A(3)(a) with:

07-15-16

Before installing inert ground cover, remove plants and weeds to the ground level.

Delete *or mulch* at each occurrence in sections 20-5.03A(3)(c) and 20-5.03A(3)(d).

07-15-16

Replace section 20-5.03E with:

07-15-16

20-5.03E Reserved

Replace section 20-5.04 with:

07-15-16

20-5.04 WOOD MULCH

20-5.04A General

20-5.04A(1) Summary

Section 20-5.04 includes specifications for placing wood mulch.

20-5.04A(2) Definitions

Reserved

20-5.04A(3) Submittals

Submit a certificate of compliance for wood mulch.

Submit a 2 cu ft mulch sample with the mulch source shown on the bag. Obtain authorization before delivering the mulch to the job site.

20-5.04A(4) Quality Assurance

Reserved

20-5.04B Materials

20-5.04B(1) General

Mulch must not contain more than 0.1 percent of deleterious materials such as rocks, glass, plastics, metals, clods, weeds, weed seeds, coarse objects, sticks larger than the specified particle size, salts, paint, petroleum products, pesticides or chemical residues harmful to plant or animal life.

20-5.04B(2) Tree Bark Mulch

Tree bark mulch must be derived from cedar, Douglas fir, or redwood species.

The mulch must be ground such that at least 95 percent of the material by volume is less than 2 inches long in any dimension and no more than 30 percent by volume is less than 1 inch long in any dimension.

20-5.04B(3) Wood Chip Mulch

Wood chip mulch must:

1. Be derived from clean wood
2. Not contain leaves or small twigs
3. Contain at least 95 percent by volume of wood chips with a width and thickness from 1/16 to 3/8 inch and a length from 1/2 to 3 inches

20-5.04B(4) Shredded Bark Mulch

Shredded bark mulch must:

1. Be derived from trees
2. Be a blend of loose, long, thin wood, or bark pieces
3. Contain at least 95 percent by volume of wood strands with a width and thickness from 1/8 to 1-1/2 inches and a length from 2 to 8 inches

20-5.04B(5) Tree Trimming Mulch

Tree trimming mulch must:

1. Be derived from chipped trees and may contain leaves and small twigs
2. Contain at least 95 percent by volume of material less than 3 inches long for any dimension and not more than 30 percent by volume of material less than 1 inch long for any dimension

20-5.04B(6)–20-5.04B(11) Reserved

20-5.04C Construction

Before placing wood mulch, remove plants and weeds to the ground level.

Maintain the planned flow lines, slope gradients, and contours of the job site. Grade the subgrade to a smooth and uniform surface.

Place mulch after the plants have been planted.

Place mulch in the plant basin at the rate described. Mulch must not come in contact with the plant crown and stem.

Place mulch as shown in areas outside of plant basins to a uniform thickness.

Spread mulch from the outside edge of the plant basin to the adjacent edges of shoulders, paving, retaining walls, dikes, edging, curbs, sidewalks, walls, fences, and existing plantings. If the plant is 12 feet or more from the adjacent edges of any of these elements, spread the mulch 6 feet beyond the outside edge of the plant basin.

Do not place mulch within 4 feet of:

1. Flow line of earthen drainage ditches
2. Edge of paved ditches
3. Drainage flow lines

20-5.04D Payment

The payment quantity for wood mulch is the volume measured in the vehicle at the point of delivery.

^^

21 EROSION CONTROL

07-15-16

Add between *tube* and 12 in the 1st paragraph of section 21-2.02Q:

8 or

07-15-16

^^

DIVISION IV SUBBASES AND BASES

23 GENERAL

07-15-16

Replace the headings and paragraphs in section 23 with:

07-15-16

23-1 GENERAL

23-1.01 GENERAL

23-1.01A Summary

Section 23 includes general specifications for constructing subbases and bases.

23-1.01B Definitions

Reserved

23-1.01C Submittals

Submit a QC plan for the types of subbases or bases where described.

23-1.01D Quality Assurance

23-1.01D(1) General

23-1.01D(1)(a) General

Take samples under California Test 125.

23-1.01D(1)(b) Test Result Disputes

You and the Engineer must work together to avoid potential conflicts and to resolve disputes regarding test result discrepancies. Notify the Engineer within 5 business days of receiving the test result if you dispute the test result.

If you or the Engineer dispute each other's test results, submit your test results and copies of paperwork including worksheets used to determine the disputed test results. An independent third party performs referee testing. Before the independent third party participates in a dispute resolution, it must be qualified under AASHTO Materials Reference Laboratory program and the Department's Independent Assurance Program. The independent third party must have no prior direct involvement with this Contract. By mutual agreement, the independent third party is chosen from:

1. Department laboratory in a district or region not in the district or region the project is located
2. Transportation Laboratory
3. Laboratory not currently employed by you or your material producer

If split acceptance samples are not available, the independent third party uses any available material representing the disputed material for evaluation.

If the independent third party determines the Department's test results are valid, the Engineer deducts the independent third party testing costs from payments. If the independent third party determines your test results are valid, the Department pays the independent third party testing costs.

23-1.01D(2) Quality Control

23-1.01D(2)(a) General

Provide a QC manager when the quantity of subbase or base is as shown in the following table:

QC Manager Requirements	
Subbase or base	Requirement
Stabilized soil (sq yd)	≥ 20,000
Aggregate subbases (cu yd)	≥ 20,000
Aggregate bases (cu yd)	≥ 20,000
CTB (cu yd)	≥ 10,000
Lean concrete base (cu yd)	≥ 2,000
Rapid strength concrete base (cu yd)	≥ 1,000
Lean concrete base rapid setting (cu yd)	≥ 1,000
Concrete base (cu yd)	≥ 1,000
Treated permeable bases (cu yd)	≥ 2,000
Reclaimed pavements (sq yd)	≥ 10,000

Provide a testing laboratory to perform quality control tests. Maintain sampling and testing equipment in proper working condition.

You are not entitled to compensation for the suspension of work resulting from noncompliance with quality control requirements, including those identified within the QC plan.

23-1.01D(2)(b) Quality Control Plan

The QC plan must describe the organization and procedures used to:

1. Control the production process
2. Determine if a change to the production process is needed
3. Implement a change

The QC plan must include action and suspension limits and details of corrective action to be taken if any process is outside of those limits. Suspension limits must not exceed specified acceptance criteria.

The QC plan must describe how test results will be submitted including times for sampling and testing for each quality characteristic.

23-1.01D(2)(c) Qualifications

Testing laboratories and testing equipment must comply with the Department's Independent Assurance Program.

Personnel performing sampling and testing must be qualified under the Department's Independent Assurance Program for the sampling and testing performed.

23-1.01D(3) Department Acceptance

Reserved

23-1.02 MATERIALS

Not Used

23-1.03 CONSTRUCTION

Not Used

23-1.04 PAYMENT

Not Used

Replace *Reserved* in section 26-1.01D(2) with:

07-15-16

26-1.01D(2)(a) General

Reserved

26-1.01D(2)(b) Quality Control Plan

Reserved

26-1.01D(2)(c) Qualifications

Reserved

26-1.01D(2)(d) Quality Control Testing

AB quality control must include testing the quality characteristics at the frequencies shown in the following table:

QC Testing Frequencies

Quality characteristic	Test method	Sampling location	Minimum frequency
R-value	California Test 301	Stockpiles, transportation units, windrows, or roadways	1 test before starting work and every 2,000 cu yd thereafter ^a
Aggregate gradation	California Test 202	Stockpiles, transportation units, windrows, or roadways	1 per 500 cu yd but at least one per day of placement
Sand equivalent	California Test 217	Stockpiles, transportation units, windrows, or roadways	1 per project
Durability index ^b	California Test 229	Stockpiles, transportation units, windrows, or roadways	
Relative compaction	California Test 231	Roadway	1 per 500 sq yd on each layer

^aAdditional R-value frequency testing will not be required when the average of 4 consecutive sand equivalent tests is 29 or greater for Class 2 AB or 25 or greater for Class 3 AB.

^bApplies if section 26-1.02 contains an applicable requirement for durability index

Add between *requirements*, and *and* in the 1st paragraph of section 26-1.01D(3):

07-15-16

durability,

Add between the 2nd and 3rd paragraphs of section 26-1.01D(3):

07-15-16

The Engineer takes aggregate base samples for R-value, aggregate gradation, sand equivalent, and durability index from any of the following locations:

1. Windrow
2. Roadway

Delete the 3rd paragraph of section 26-1.01D(3).

07-15-16

AA

27 CEMENT TREATED BASES

07-15-16

Add to section 27-1.01C:

Submit cement treated base QC plan.

07-15-16

Replace the headings and paragraphs in section 27-1.01D with:

07-15-16

27-1.01D Quality Assurance

27-1.01D(1) General

After the CTB has been spread on the subgrade and before initial compaction, the cement content of the completed mixture of CTB must not vary from the specified cement content by more than 0.6 percent of the weight of the dry aggregate when tested under California Test 338.

For Class A CTB, compaction is tested under California Test 312 or 231.

The relative compaction of CTB must be at least 95 percent. Each layer of CTB may be tested for compaction, or all layers may be tested together at the option the Engineer. If all layers are tested together, you are not relieved of the responsibility to achieve the required compaction in each layer placed.

27-1.01D(1)(a) Aggregate

When tested under California Test 301, aggregate for Class B CTB must have (1) an R-value of at least 60 before mixing with cement and (2) an R-value of at least 80 when aggregate is mixed with an amount of cement that does not exceed 2.5 percent by weight of the dry aggregate.

Before sand equivalent testing, aggregate samples must not be treated with lime, cement, or chemicals.

If the aggregate gradation test results, the sand equivalent test results, or both comply with contract compliance requirements but not operating range requirements, you may continue placing CTB for the remainder of the work day. Do not place additional CTB until you demonstrate to the Engineer that the CTB to be placed complies with the operating range requirements.

If the aggregate gradation test results, sand equivalent test results, or both do not comply with contract compliance requirements, remove the CTB or request a payment deduction. If your request is authorized, \$2.50/cu yd is deducted. If CTB is paid for by weight, the Engineer converts tons to cubic yards for the purpose of reducing payment for noncompliant CTB left in place. An aggregate gradation and a sand equivalent test represents up to (1) 500 cu yd or (2) 1 day's production if less than 500 cu yd.

27-1.01D(1)(b) Road-Mixed Cement Treated Base Moisture Content

Just before initial compaction the moisture content of the completed mixture must be at least the optimum moisture content less 1 percent. The moisture content is determined under California Test 226 and optimum moisture content is determined under California Test 312.

27-1.01D(1)(c) Plant-Mixed Cement Treated Base Moisture Content

At the point of delivery to the work, the moisture content of the completed mixture must be at least the optimum moisture content less 1 percent. The moisture content is determined under California Test 226 and optimum moisture content under California Test 312.

27-1.01D(2) Quality Control

27-1.01D(2)(a) General

Reserved

27-1.01D(2)(b) Quality Control Plan

Reserved

27-1.01D(2)(c) Qualifications

Reserved

27-1.01D(2)(d) Quality Control Testing

CTB quality control must include testing the quality characteristics at the frequencies shown in the following table:

QC Testing Frequencies

Quality characteristic	Test method	Sampling location	Minimum frequency
Aggregate gradation	California Test 202 modified	Stockpiles, plant, transportation units, windrow, or roadway	1 per 500 cu yd but at least one per day of placement
Sand equivalent	California Test 217	Stockpiles, plant, transportation units, windrow, or roadway	
R-value ^a	California Test 301	Stockpiles, plant, transportation units, windrows, or roadway	1 test before starting work and every 2000 cu yd thereafter ^b
Optimum moisture content	California Test 312	Plant, transportation units, windrow, or roadway	1 per day of placement
Moisture content	California Test 226	Roadway	1 per 500 cu yd but at least one per day of placement
Cement content	California Test 338	Windrows or roadway	1 per 1000 cu yd but at least one per day of placement
Relative compaction	California Test 312 or 231	Roadway	1 per 2000 sq yd but at least one per day of placement
Compressive strength ^c	California Test 312	Windrow or roadways	1 per day of placement

^aR-value is required for Class B CTB only

^bAdditional R-value frequency testing will not be required while the average of 4 consecutive sand equivalent tests is 4 or more above the specified operating range value.

^cCompressive strength is required for Class A CTB only when specified

27-1.01D(3) Department Acceptance

The Department's acceptance testing includes testing the CTB quality characteristics shown in the following table:

CTB Requirements for Acceptance

Quality characteristic	Test method
Aggregate gradation	California Test 202 modified
Sand equivalent	California Test 217
R-value ^a	California Test 301
Optimum moisture content	California Test 312
Moisture content	California Test 226
Cement content	California Test 338
Relative compaction	California Test 312 or 231
Compressive strength ^b	California Test 312

^aR-value is required for Class B CTB only

^bCompressive strength is required for Class A CTB only when specified

The Engineer takes samples for aggregate gradation and sand equivalent from any of the following locations:

1. Plant

2. Truck
3. Windrow, for road-mixed only
4. Roadbed, for road-mixed only

Add to section 27-1.02:

Water must comply with section 90-1.02D.

07-15-16

Add to section 27-1.03F:

The relative compaction of CTB must be at least 95 percent.

07-15-16

^^

28 CONCRETE BASES

07-15-16

Replace the headings and paragraphs in section 28-1.01D with:

07-15-16

28-1.01D Quality Assurance

28-1.01D(1) General

Aggregate samples must not be treated with lime, cement, or chemicals before testing for sand equivalent.

Stop concrete base activities and immediately notify the Engineer whenever:

1. Any QC or QA test result does not comply with the specifications
2. Visual inspection shows a noncompliant concrete base

If concrete base activities are stopped, before resuming activities:

1. Notify the Engineer of the adjustments you will make
2. Remedy or replace the noncompliant concrete base
3. Field qualify or construct a new test strip as specified for the concrete base involved to demonstrate compliance with the specifications
4. Obtain authorization

28-1.01D(2) Quality Control

28-1.01D(2)(a) General

Reserved

28-1.01D(2)(b) Quality Control Plan

Reserved

28-1.01D(2)(c) Qualifications

Reserved

28-1.01D(3) Department Acceptance

Reserved

Add to section 28-2.01C(1):

Submit a lean concrete base QC plan.

07-15-16

Replace the headings and paragraphs in section 28-2.01D with:

07-15-16

28-2.01D Quality Assurance

28-2.01D(1) General

28-2.01D(1)(a) General

The molds for compressive strength testing under ASTM C31 or ASTM C192 must be 6 by 12 inches.

If the aggregate gradation test results, sand equivalent test results or both comply with the contract compliance requirements but not the operating range requirements, you may continue placing LCB for the remainder of the work day. Do not place additional LCB until you demonstrate the LCB to be placed complies with the operating range requirements.

28-2.01D(1)(b) Qualifications

Field qualification tests and calculations must be performed by an ACI certified "Concrete Laboratory Technician, Grade I.

28-2.01D(1)(c) Aggregate Qualification Testing

Qualify the aggregate for each proposed aggregate source and gradation. The qualification tests include (1) a sand equivalent and (2) an average 7-day compressive strength under ASTM C39 of 3 cylinders manufactured under ASTM C192 except cure cylinders in molds without lids after initial curing.

For the compressive strength test, the cement content for each cylinder must be 300 lb/cu yd. The 7-day average compressive strength must be at least 610 psi. The cement must be Type II portland cement.

LCB must have from 3 to 4 percent air content during aggregate qualification testing.

28-2.01D(1)(d) Field Qualification Testing

Before placing LCB, you must perform field qualification testing and obtain authorization for each mix design. Retest and obtain authorization for changes to the authorized mix designs.

Notify the Engineer at least 5 business days before field qualification. Perform the field qualification at the job site or an authorized location.

Field qualification testing includes tests for compressive strength, air content, and penetration or slump.

For compressive strength field qualification testing:

1. Prepare 12 cylinders under ASTM C31 except final cure cylinders in molds without lids from a single batch.
2. Perform 3 tests; each test consists of determining the average compressive strength of 2 cylinders at 7 days under ASTM C39. The average compressive strength for each test must be at least 530 psi

If you submitted a notice to produce LCB qualifying for a transverse contraction joint waiver, manufacture additional specimens and test the LCB for compressive strength at 3 days. Prepare the compressive strength cylinders under ASTM C31 except final cure cylinders in molds without lids at the same time using the same material and procedures as the 7-day compressive strength cylinders except do not submit 6 additional test cylinders. The average 3-day compressive strength for each test must be not more than 500 psi.

28-2.01D(2) Quality Control

28-2.01D(2)(a) General

Reserved

28-2.01D(2)(b) Quality Control Manager

Reserved

28-2.01D(2)(c) Quality Control Testing

Test the LCB under the test methods and at the locations and frequencies shown in the following table:

LCB Sampling Location and Testing Frequencies

Quality characteristic	Test method	Sampling location	Minimum sampling and testing frequency
Sand equivalent	ASTM D2419	Source	1 per 500 cubic yards but at least 1 per day of production
Aggregate gradation	ASTM C136		
Air content	ASTM C231	Job site	
Penetration ^a	ASTM C360		
Slump ^a	ASTM C143		
Compressive strength	ASTM C39 ^b		

^aTest for either penetration or slump

^bPrepare cylinders under ASTM C31 except final cure cylinders in molds without lids.

28-2.01D(3) Department Acceptance

The Department accepts LCB based on compliance with the requirements shown in the following table:

LCB Requirements for Acceptance

Quality characteristic	Test method	Requirement
Compressive strength (min, psi at 7 days)	ASTM C39 ^a	530 ^b

^aCylinders prepared under ASTM C31 except final cure cylinders in molds without lids.

^bA compressive strength test represents up to (1) 1,000 cu yd or (2) 1 day's production if less than 1,000 cu yd.

Replace section 28-2.01D(4) in item 3 of the 5th paragraph in section 28-2.03D with:

07-15-16

section 28-2.01D(1)(c)

Replace the 1st paragraph in section 28-2.03F with:

07-15-16

After finishing LCB, cure LCB with pigmented curing compound under section 90-1.03B(3) and 40-1.03I. Apply curing compound:

1. In 2 separate applications
2. Before the atmospheric temperature falls below 40 degrees F
3. At a rate of 1 gal/150 sq ft for the first application
4. At a rate of 1 gal/200 sq ft for the second application

Replace *Reserved* in section 28-3.01C(3) with:

07-15-16

Submit a rapid strength concrete base QC plan.

Replace the headings and paragraphs in section 28-3.01D with:

07-15-16

28-3.01D Quality Assurance

28-3.01D(1) General

28-3.01D(1)(a) General

At the preconstruction meeting be prepared to discuss the project specifications and methods of performing each item of work. Items discussed must include the processes for:

1. Production
2. Transportation

3. Placement
4. QC plan, if specified in the special provisions
5. Contingency plan
6. QC sampling and testing
7. Acceptance criteria

Beams for modulus of rupture testing must be fabricated and tested under California Test 524. The beams may be fabricated using an internal vibrator under ASTM C31. For each test, 3 beam must be fabricated and the test results averaged. No single test represents more than that day's production or 130 cu yd, whichever is less.

For early age testing, beams must be cured so the monitored temperatures in the beams and the test strip are always within 5 degrees F. The internal temperatures of the RSC base and early age beams must be monitored and recorded at intervals of at least 5 minutes. Thermocouples or thermistors connected to strip-chart recorders or digital data loggers must be installed to monitor the temperatures. Temperature recording devices must be accurate to within ± 2 degrees F. Until early age testing is completed, internal temperatures must be measured at 1 inch from the top, 1 inch from the bottom, and no closer than 3 inches from any edge.

For other age testing, beams must be cured under California Test 524 except beams must be placed into sand at a time that is the earlier of either from 5 to 10 times the final set time, or 24 hours.

RSC base must have an opening age modulus of rupture of not less than 400 psi and a 7-day modulus of rupture of not less than 600 psi.

28-3.01D(1)(b) Preconstruction Meeting

Reserved

28-3.01D(1)(c) Test Strip

Reserved

28-3.01D(2) Quality Control

28-3.01D(2)(a) General

Reserved

28-3.01D(2)(b) Quality Control Manager

Reserved

28-3.01D(2)(c) Quality Control Testing

Test the rapid strength concrete base under the test methods and at the locations and frequencies shown in the following table:

Rapid Strength Concrete Base Sampling Location and Testing Frequencies

Quality characteristic	Test method	Sample Location	Minimum testing frequency ^a
Cleanness value	California Test 227	Source	1 per 500 cubic yards but at least 1 per shift
Sand equivalent	California Test 217		
Aggregate gradation	California Test 202		
Air content	California Test 504	Job site	1 per 130 cu yd but at least 1 per shift
Yield	California Test 518		1 per shift
Slump or penetration	ASTM C143 or California Test 533		1 per 2 hours of placement
Density	California Test 518		1 per shift
Aggregate moisture meter calibration ^b	California Test 223 or California Test 226		1 per shift
Modulus of rupture	California Test 524		1 per 130 cu yd but at least 1 per shift

^aTest at the most frequent interval.

^bCheck calibration of the plant moisture meter by comparing moisture meter readings with California Test 223 or California Test 226 test results.

Notify the Engineer at least 2 business days before any sampling and testing. Submit testing results within 15 minutes of testing completion. Record inspection, sampling, and testing on the forms accepted with the QC plan and submit them within 48 hours of completion of each day of production and within 24 hours of 7-day modulus of rupture tests.

During the placement of RSC base, fabricate beams and test for the modulus of rupture:

1. At opening age
2. At 7 days after placing the first 30 cu yd
3. At least once every 130 cu yd
4. Within the final truckload

Opening age tests must be performed in the presence of the Engineer.

28-3.01D(3) Department Acceptance

The Department accepts RSC base based on compliance with the requirements shown in the following table:

RSC Base Requirements for Acceptance

Quality characteristic	Test method	Requirement
Modulus of rupture (min, psi at 7 days)	California Test 524	600

The Engineer adjust payment for RSC base for the 7-day modulus of rupture as follows:

1. Payment for a base with a modulus of rupture of 600 psi or greater is not adjusted.
2. Payment for a base with a modulus of rupture of less than 600 and greater than or equal to 550 psi is reduced by 5 percent.
3. Payment for a base with a modulus of rupture of less than 550 and greater than or equal to 500 psi is reduced by 10 percent.
4. Payment for a base with a modulus of rupture of less than 500 psi is not adjusted and no payment is made. Remove and replace this base.

Add to section 28-4.01C(1):

Submit a lean concrete base rapid setting QC plan.

07-15-16

Replace the headings and paragraphs in section 28-4.01D with:

07-15-16

28-4.01D Quality Assurance

28-4.01D(1) General

28-4.01D(1)(a) General

For compressive strength testing, prepare 6 cylinders under California Test 540. Test cylinders must be 6 by 12 inches. As an alternative to rodding, a vibrator may be used under California Test 524. Test cylinders under California Test 521 and perform 3 tests with each test consisting of 2 cylinders. The test result is the average from the 2 cylinders.

28-4.01D(1)(b) Field Qualification

Before placing lean concrete base rapid setting, you must perform field qualification testing and obtain authorization for each mix design. Retest and obtain authorization for changes to authorized mixed designs.

Proposed mix designs must be field qualified before you place the base represented by those mix designs. The technician performing the field test must hold current ACI certification as a Concrete Field Testing Technician-Grade I.

Notify the Engineer at least 5 days before field qualification. Perform field qualification within the job site or a location authorized.

Field qualification testing includes compressive strength, air content, and penetration or slump in compliance with the table titled "Lean Concrete Base Rapid Setting Requirements."

Field qualification must comply with the following:

1. Test for compressive strength at opening age and 7 days of age
2. At opening age, the compressive strength for each test must be at least 180 psi and the average strength for the 3 tests must be at least 200 psi
3. At 7 days age, the compressive strength for each test must be at least 600 psi and the average strength for the 3 tests must be at least 725 psi

28-4.01D(2) Quality Control

28-4.01D(2)(a) General

Reserved

28-4.01D(2)(b) Quality Control Manager

Reserved

28-4.01D(2)(c) Quality Control Testing

Test the base under the test methods and at the locations and frequencies shown in the following table:

LCB Rapid Setting Sampling Location and Testing Frequencies

Quality characteristic	Test method	Sampling location	Minimum sampling and testing frequency
Sand equivalent	ASTM D2419	Source	1 per 500 cu yd, minimum 1 per day of production
Aggregate gradation	ASTM C136		
Air content	ASTM C231	Job site	1 per 4 hours of placement work, plus one in the last hour of placement work
Penetration ^a	ASTM C360		
Slump ^a	ASTM C143		
Compressive strength	California Test 521		

^aTest either penetration or slump

During placement of lean concrete base rapid setting, fabricate cylinders and test compressive strength for opening age and 7 days. Opening age tests must be performed in the presence of the Engineer.

28-4.01D(3) Department Acceptance

The Department accepts LCB rapid setting based on compliance with the requirement shown in the following table:

LCB Rapid Setting Requirements for Acceptance

Quality characteristic	Test method	Requirement
Compressive strength (min, psi at 7 days)	California Test 521 ^a	725

^aCylinders made under California Test 540

Replace the 2nd and 3rd paragraphs in section 28-4.03A with:

07-15-16

Concrete paving operations with equipment not supported by the base may start before opening age. Do not open pavement for traffic before opening age of the LCB rapid setting.

Any other paving operations must start after the final set time of the base. The base must have a compressive strength of at least 450 psi under California Test 521 before:

1. Placing HMA
2. Placing other base material
3. Operating equipment on the base

Replace *Reserved* in section 28-5.01C with:

07-15-16

Submit a concrete base QC plan.

Replace the headings and paragraphs in section 28-5.01D(2) with:

07-15-16

28-5.01D(2) Quality Control

28-5.01D(2)(a) General

Reserved

28-5.01D(2)(b) Quality Control Manager

Reserved

28-5.01D(2)(c) Quality Control Testing

Test the concrete base under the test methods and at the locations and frequencies shown in the following table:

Concrete Base Sampling Location and Testing Frequencies

Quality characteristic	Test method	Sample location	Minimum testing frequency ^a
Cleanness value	California Test 227	Source	1 per 500 cubic yards but at least 1 per shift
Sand equivalent	California Test 217		
Aggregate gradation	California Test 202		
Air content	California Test 504	Job site	1 per 500 cu yd but at least 1 per shift
Yield	California Test 518		1 per shift
Slump or penetration	ASTM C143 or California Test 533		1 per 2 hours of placement
Density	California Test 518		1 per shift
Aggregate moisture meter calibration ^b	California Test 223 or California Test 226		1 per shift
Modulus of rupture	California Test 524		1 per 500 cu yd but at least 1 per shift

^aTest at the most frequent interval.

^bCheck calibration of the plant moisture meter by comparing moisture meter readings with California Test 223 or California Test 226 test results.

28-5.01D(3) Department Acceptance

The Department accepts a concrete base based on compliance with the requirements shown in the following table:

Concrete Base Requirements for Acceptance

Quality characteristic	Test method	Requirement
Modulus of rupture (min, psi at 28 days)	California Test 523	570

Acceptance for the modulus of rupture is on a lot basis. The Department provides the molds and machines for the modulus of rupture acceptance testing. Provide any material and labor the Engineer may require for the testing.

AA

29 TREATED PERMEABLE BASES

07-15-16

Replace the headings and paragraphs in section 29-1.01 with:

07-15-16

29-1.01 GENERAL

29-1.01A Summary

Section 29-1 includes general specifications for constructing treated permeable bases.

29-1.01B Definitions

Reserved

29-1.01C Submittals

Submit a treated permeable base quality control plan.

29-1.01D Quality Assurance

29-1.01D(1) General

Reserved

29-1.01D(2) Quality Control**29-1.01D(2)(a) General**

Reserved

29-1.01D(2)(b) Quality Control Plan

Reserved

29-1.01D(2)(c) Qualifications

Reserved

29-1.01D(3) Department Acceptance

Reserved

Replace the headings and paragraphs in section 29-2.01D with:

07-15-16

29-2.01D Quality Assurance**29-2.01D(1) General**

The Engineer determines the asphalt content of the asphalt mixture under California Test 382. The bitumen ratio, pounds of asphalt per 100 lb of dry aggregate, must not vary more than 0.5 lb of asphalt above or below the quantity designated by the Engineer. Samples used to determine the bitumen ratio are obtained from trucks at the plant or from the mat behind the paver before rolling. If the sample is taken from the mat behind the paver, the bitumen ratio must not be less than the quantity designated by the Engineer, less 0.7 lb of asphalt per 100 lb of dry aggregate.

29-2.01D(2) Quality Control**29-2.01D(2)(a) General**

Reserved

29-2.01D(2)(b) Quality Control Testing

ATPB quality control must include testing the quality characteristics at the frequencies shown in the following table:

QC Testing Frequencies

Quality characteristic	Test method	Sampling location	Minimum frequency
Gradation	California Test 202	Stockpiles or plant	1 for every 4 hours of production but at least one per day of placement
Cleanness value	California Test 227	Stockpiles or plant	1 for every 4 hours of production but at least one per day
Percentage of crushed particles	California Test 205	Stockpiles or plant	1 test before production and one every 5,000 cu yd thereafter
Los Angeles rattler loss at 500 rev	California Test 211	Stockpiles or plant	1 test before production and one every 5,000 cu yd thereafter
Film stripping	California Test 302	Plant	1 test before production and one every 5000 cu yd thereafter
Asphalt content of the asphalt mixture	California Test 382	Plant, transportation units, windrows, or roadway	1 for every 4 hours of production but at least one per day

29-2.01D(3) Department Acceptance

The Department accepts ATPB based on aggregate gradation, cleanness value, percent of crushed particles, Los Angeles rattler, film stripping and asphalt content requirements specified in section 29-2.02 and section 29-2.01D(1).

The Engineer takes samples for aggregate gradation, cleanness value, percent of crushed particles, Los Angeles rattler, and film stripping from the plant.

The Engineer takes samples for asphalt content of the asphalt mixture from any of the following locations:

1. Plant
2. Truck
3. Windrow
4. Roadbed

Replace the headings and paragraphs in section 29-3.01 with:

07-15-16

29-3.01 GENERAL

29-3.01A Summary

Section 29-3 includes specifications for constructing cement treated permeable bases.

29-3.01B Definitions

Reserved

29-3.01C Submittals

Reserved

29-3.01D Quality Assurance

29-3.01D(1) General

Reserved

29-3.01D(2) Quality Control

29-3.01D(2)(a) General

Reserved

29-3.01D(2)(b) Quality Control Testing

CTPB quality control must include testing the quality characteristics at the frequencies shown in the following table:

QC Testing Frequencies

Quality characteristic	Test method	Sampling location	Minimum frequency
Gradation	California Test 202	Stockpiles or plant	1 for every 4 hours of production but at least one per day of placement
Cleanness value	California Test 227	Stockpiles or plant	1 for every 4 hours of production but at least one per day
Los Angeles rattler loss at 500 rev	California Test 211	Stockpiles or plant	1 test before production and one every 5,000 cu yd thereafter
Soundness	California Test 214	Stockpiles or plant	1 test before production and one every 5,000 cu yd thereafter

29-3.01D(3) Department Acceptance

The Department accepts CTPB based on aggregate gradation, cleanness value, Los Angeles rattler and soundness requirements in section 29-3.02.

The Engineer takes samples for aggregate gradation, cleanness value, Los Angeles rattler and soundness from the plant.

Add to section 29-3.02A:

Water must comply with section 90-1.02D.

07-15-16

Replace 3rd in the 2nd paragraph in section 29-3.03 with:

4th

07-15-16

^^

30 RECLAIMED PAVEMENT

07-15-16

Replace section 30-1.01C(2)(c) in the 1st paragraph of section 30-3.01C(2)(c) with:

section 30-1.01C(3)(c)

07-15-16

Replace the table in section 30-3.02A with:

07-15-16

FDR—Foamed Asphalt Quality Characteristic Requirements

Quality characteristic	Test method	Requirement
Moisture content before HMA paving	California Test 226	< 50% of OMC
Asphalt binder expansion ratio (min, %)	Note a	10
Asphalt binder half-life (seconds, min)		12
Gradation (% passing) Sieve Size: 3 inch 2 inch 1-1/2 inch	California Test 202	100 95–100 85–100
Moisture content Maximum Minimum	California Test 226	OMC OMC - 2%
In-place wet density (lb/cu ft)	California Test 216	Report only
Relative compaction (min, %)	California Test 231	98
Indirect dry tensile strength (psi) ^b	California Test 371	90% of mix design value
Indirect wet tensile strength (psi) ^b	California Test 371	90% of mix design value
Tensile strength ratio (%)	California Test 371	90% of mix design value

^aTest at the foaming temperature and percentage of foaming water by dry weight of FDR—foamed asphalt material designated in the mix design. To test asphalt binder expansion ratio and half-life, use a pail of known volume and a dipstick calibrated for the pail. From the inspection nozzle on the asphalt binder spray bar, inject foamed asphalt into the pail without exceeding the pail's capacity. With the dipstick, immediately measure and record the level of foamed asphalt in the pail. Record the half-life in seconds from the time the injection of foamed asphalt in the pail is turned off to half the dipstick reading after peak. Calculate the expansion ratio as the volume of the foamed asphalt upon injection divided by the volume of the unfoamed asphalt binder.

^bFrom material passing the 1-inch sieve, compact 6 specimens under California Test 304, Part 2. Cure the specimens at 100 °F for 72 hours and allow the specimens to cool to room temperature. Test 3 specimens for dry tensile strength under California Test 371. Test 3 specimens for wet tensile strength under California Test 371 after moisture conditioning.

Replace section 30-4.01D(3) in the 2nd paragraph of section 30-4.01D(1) with:

section 30-4.01D(4)

07-15-16

Replace section 30-4.01D(1)(a) in the table in section 30-4.02A with:

section 30-4.01D(2)

07-15-16

^^

DIVISION V SURFACINGS AND PAVEMENTS

37 BITUMINOUS SEALS

07-15-16

Replace section 37 with:

07-15-16

37 SEAL COATS

37-1 GENERAL

37-1.01 GENERAL

37-1.01A Summary

Section 37-1 includes general specifications for applying seal coats.

37-1.01B Definitions

Reserved

37-1.01C Submittals

At least 10 days before the preconstruction meeting submit a list of participants in the preconstruction meeting. Provide each participant's name, employer, title, and role in the production and placement of the seal coats.

At least 10 days before starting seal coat activities, submit the names of the authorized laboratories for quality control testing.

For each delivery of asphalt binder or asphaltic emulsion to the job site, submit a certificate of compliance and a copy of the specified test results.

For a seal coat that uses crumb rubber modifier, submit a Crumb Rubber Usage Report form monthly and at the end of project.

37-1.01D Quality Assurance

37-1.01D(1) General

For aggregate testing, quality control laboratories must be in compliance with the Department's Independent Assurance Program to be an authorized laboratory. Quality control personnel must be qualified under the Department's Independent Assurance Program.

For emulsion testing, quality control laboratories must participate in the AASHTO Material's Reference Laboratory proficiency sample program.

37-1.01D(2) Preconstruction Meeting

Hold a preconstruction meeting within 5 days before start of seal coat work at a mutually agreed time and place with the Engineer and your:

1. Project superintendent
2. Project foreman
3. Traffic control foreman

Make arrangements for the conference facility. Preconstruction meeting participants must sign an attendance sheet provided by the Engineer. Be prepared to discuss:

1. Quality control testing
2. Acceptance testing
3. Seal coat placement
4. Proposed application rates for asphaltic emulsion or asphalt binder and aggregate.
5. Training on placement methods
6. Checklist of items for proper placement
7. Unique issues specific to the project, including:
 - 7.1. Weather
 - 7.2. Alignment and geometrics
 - 7.3. Traffic control requirements

- 7.4. Haul distances
- 7.5. Presence and absence of shaded areas
- 7.6. Any other local conditions
- 8. Contingency plan for material deliveries, equipment breakdowns, and traffic handling
- 9. Who in the field has authority to adjust application rates and how adjustments will be documented
- 10. Schedule of sweepings

37-1.02 MATERIALS

Not Used

37-1.03 CONSTRUCTION

37-1.03A General

If seal coat activities affect access to public parking, residential property, or commercial property, post signs at 100-foot intervals on the affected streets. Signs must display *No Parking – Tow Away*. Signs must state the dates and hours parking or access will be restricted. Notify residents, businesses, and local agencies at least 24 hours before starting activities. The notice must:

- 1. Describe the work to be performed
- 2. Detail streets and limits of activities
- 3. Indicate dates and work hours
- 4. Be authorized

Asphaltic emulsion or asphalt binder for seal coats may be reheated if necessary. After loading the asphaltic emulsion or asphalt binder into a truck for transport to the job site, do not heat asphaltic emulsion above 160 degrees F and asphalt rubber binder above 425 degrees F. During reheating, circulate or agitate the asphaltic emulsion or asphalt binder to prevent localized overheating.

Except for fog seals, apply quick setting Grade 1 asphaltic emulsions at a temperature from 75 to 130 degrees F and apply quick setting Grade 2 asphaltic emulsions at a temperature from 110 to 185 degrees F.

You determine the application rates for asphaltic emulsion or asphalt binder and aggregate and the Engineer authorizes the application rates.

37-1.03B Equipment

A self-propelled distributor truck for applying asphaltic emulsion or asphalt binder must be equipped with:

- 1. Pressure-type system with insulated tanks with circulating unit
- 2. Spray bars:
 - 2.1. With minimum length of 9 feet and full-circulating type
 - 2.2. With full-circulating-type extensions if needed to cover a greater width
 - 2.3. Adjustable to allow positioning at various heights above the surface to be treated
 - 2.4. Operated by levers such that 1 or all valves may be quickly opened or closed in one operation
- 3. Devices and charts to provide for accurate and rapid determination and control of asphaltic emulsion or asphalt binder quantities being applied. Include an auxiliary wheel type meter that registers:
 - 3.1. Speed in ft/min
 - 3.2. Trip by count
 - 3.3. Total distance in feet
- 4. Distribution system:
 - 4.1. Capable of producing a uniform application of asphaltic emulsion or asphalt binder in controlled quantities ranging from 0.02 to 1 gal/sq yd of surface and at a pressure ranging from 25 to 75 psi
 - 4.2. Pumps that spray asphaltic emulsion or asphalt binder within 0.02 gal/sq yd of the set rate
 - 4.3. With a hose and nozzle for application of asphaltic emulsion to areas inaccessible to the spray bar
 - 4.4. With pressure gauges and a thermometer for determining temperatures of the asphaltic emulsion or asphalt binder

You may use cab-controlled valves for the application of asphaltic emulsion or asphalt binder. The valves controlling the flow from nozzles must act positively to provide a uniform unbroken application of asphaltic emulsion or asphalt binder.

Maintain distributor and storage tanks at all times to prevent dripping.

37-1.04 PAYMENT

Not Used

37-2 CHIP SEALS

37-2.01 GENERAL

37-2.01A General

37-2.01A(1) Summary

Section 37-2.01 includes general specifications for applying chip seals.

37-2.01A(2) Definitions

Reserved

37-2.01A(3) Submittals

At least 15 days before starting placement of chip seal, submit:

1. Samples for:
 - 1.1. Asphaltic emulsion chip seal, two 1-quart wide mouth plastic containers with screw top lid of asphaltic emulsion
 - 1.2. Polymer modified asphaltic emulsion chip seal, two 1-quart wide mouth plastic containers with screw top lid of polymer modified asphaltic emulsion
 - 1.3. Asphalt rubber binder chip seal, two 1-quart cans of base asphalt binder
 - 1.4. Asphalt rubber binder chip seal, five 1-quart cans of asphalt rubber binder
2. Asphaltic emulsion, polymer modified asphaltic emulsion, asphalt binder or asphalt rubber binder data as follows:
 - 2.1. Supplier and Type/Grade of asphaltic emulsion or asphalt binder
 - 2.2. Type of modifier used including polymer or crumb rubber or both
 - 2.3. Percent of crumb rubber, if used as modifier
 - 2.4. Copy of the specified test results for asphaltic emulsion or asphalt binder
3. 50 lb of uncoated aggregate
4. Aggregate test results for the following:
 - 4.1. Gradation
 - 4.2. Los Angeles Rattler
 - 4.3. Percent of crushed particles
 - 4.4. Flat and elongated particles
 - 4.5. Film stripping
 - 4.6. Cleanness value
 - 4.7. Durability
5. Vialit test results

Submit quality control test results for the quality characteristics within the reporting times allowance after sampling shown in the following table:

Quality Control Test Result Reporting

Quality characteristic	Maximum reporting time allowance
Los Angeles Rattler loss (max, %)	48 hours
Percent of crushed particles (min, %)	48 hours
Flat and elongated particles (max by weight at 3:1, %)	48 hours
Film stripping (max, %)	48 hours
Durability (min)	48 hours
Gradation (percentage passing)	24 hours
Cleanness value (min)	24 hours
Asphaltic emulsion spread rate (gal/sq yd)	24 hours

Within 3 days after taking asphaltic emulsion or asphalt binder quality control samples, submit the authorized laboratory's test results.

37-2.01A(4) Quality Assurance

37-2.01A(4)(a) General

Reserved

37-2.01A(4)(b) Quality Control

37-2.01A(4)(b)(i) General

Reserved

37-2.01A(4)(b)(ii) Aggregate

All tests must be performed on uncoated aggregate except for film stripping which must be performed on precoated aggregate.

For aggregate, the authorized laboratory must perform sampling and testing at the specified frequency and location for the following quality characteristics:

Aggregate Quality Control Requirements

Quality characteristic	Test method	Minimum sampling and testing frequency	Location of sampling
Los Angeles Rattler loss (max, %) At 100 revolutions At 500 revolutions	California Test 211	1st day of production	See California Test 125
Percent of crushed particles Coarse aggregate (min, %) One-fractured face Two-fractured faces Fine aggregate (min, %) (Passing No. 4 sieve and retained on No. 8 sieve) One fractured face	AASHTO T 335	1st day of production	See California Test 125
Flat and elongated particles (max by weight at 3:1, %)	ASTM D4791	1st day of production	See California Test 125
Film stripping (max, %)	California Test 302	1st day of production	See California Test 125
Durability (min)	California Test 229	1st day of production	See California Test 125
Gradation (% passing)	California Test 202	2 per day	See California Test 125
Cleanness value (min)	California Test 227	2 per day	See California Test 125

37-2.01A(4)(b)(iii) Chip Seals

For a chip seal, the authorized laboratory must perform sampling and testing at the specified frequency and location for the following quality characteristics:

Chip Seal Quality Control Requirements

Quality characteristic	Test method	Minimum sampling and testing frequency	Location of sampling
Asphaltic emulsion binder spread rate (gal/sq yd)	California Test 339	1 per day per distributor truck	Pavement surface

37-2.01A(4)(c) Department Acceptance

Department Acceptance shall not apply to identified areas where the existing surfacing before application of chip seal, contains defective areas as determined by the Engineer and Contractor. At least 7 days

before starting placement of the chip seal, the Contractor shall submit a written list of existing defective areas, identifying the lane direction, lane number, starting and ending highway post mile locations, and defect type. The Engineer must agree on which of the identified areas are defective.

Defective areas are defined as one of the following:

1. Areas with wheel path rutting in excess of 3/8 inch when measured by placing a straightedge 12 feet long on the finished surface perpendicular to the center line and measuring the vertical distance between the finished surface and the lower edge of the straightedge
2. Areas exhibiting flushing

For a chip seal, acceptance is based on visual inspection for the following:

1. Uniform surface texture
2. Raveling, which consists of the separation of the aggregate from the asphaltic emulsion or asphalt binder
3. Flushing, which consists of the occurrence of a film of asphaltic material on the surface of the chip seal.
4. Streaking, which consists of alternating longitudinal bands of asphaltic emulsion or asphalt binder without uniform aggregate retention, approximately parallel with the lane line.

Areas of raveling, flushing or streaking that are greater than 0.5 sq ft shall be considered defective and must be repaired.

Raveling and streaking must be repaired by placing an additional layer of chip seal over the defective area.

For asphaltic emulsion or asphalt binder, acceptance is based on the Department's sampling and testing for compliance with the requirements for the quality characteristics specified.

For aggregate, acceptance is based on the Department's sampling and testing for compliance with the requirements shown in the following table:

Chip Seal Aggregate Acceptance Criteria

Quality characteristic	Test method	Requirements
Los Angeles Rattler loss (max, %)		
At 100 revolutions	California Test 211	10
At 500 revolutions		40
Percent of crushed particles:	AASHTO T 335	
Coarse aggregate (min, %)		
One-fractured face		95
Two-fractured faces		90
Fine aggregate (min, %)		
(Passing No. 4 sieve and retained on No. 8 sieve)		
One fractured face		70
Flat and elongated particles (max by weight at 3:1, %)	ASTM D4791	10
Film stripping (max, %)	California Test 302	25
Durability (min)	California Test 229	52
Gradation (% passing by weight)	California Test 202	Aggregate Gradation table shown under Materials for the chip seal type specified.
Cleanness value (min)	California Test 227	80

If test results for the aggregate gradation do not comply with specifications, you may remove the chip seal represented by these tests or request that it remain in place with a payment deduction. The deduction is \$1.75 per ton for the aggregate represented by the test results.

If test results for aggregate cleanness value do not comply with the specifications, you may remove the chip seal represented by these tests or you may request that the chip seal remain in place with a pay deduction corresponding to the cleanness value shown in the following table:

Chip Seal Cleanness Value Deductions

Cleanness value	Deduction
80 or over	None
79	\$2.00 /ton
77-78	\$4.00 /ton
75-76	\$6.00 /ton

If the aggregate cleanness value is less than 75, remove the chip seal.

37-2.01B Materials

37-2.01B(1) General

Reserved

37-2.01B(2) Asphaltic Emulsions and Asphalt Binders

Reserved

37-2.01B(3) Aggregate

37-2.01B(3)(a) General

Aggregate must be broken stone, crushed gravel, or both.

Aggregate must comply with the requirements shown in the following table:

Chip Seal Aggregate Requirements

Quality characteristic	Test method	Requirements
Los Angeles Rattler loss (max, %)		
At 100 revolutions	California Test 211	10
At 500 revolutions		40
Percent of crushed particles	AASHTO T 335	
Coarse aggregate (min, %)		
One-fractured face		95
Two-fractured faces		90
Fine aggregate (min, %)		
(Passing No. 4 sieve and retained on No. 8 sieve)		
One fractured face		70
Flat and elongated particles (max by weight at 3:1, %)	ASTM D4791	10
Film stripping (max, %)	California Test 302	25
Durability (min)	California Test 229	52
Gradation (% passing by weight)	California Test 202	Aggregate Gradation table shown under Materials for the chip seal type specified.
Cleanness value (min)	California Test 227	80

The authorized laboratory must conduct the Vialit test using the proposed asphaltic emulsion or asphalt binder and aggregate for compliance with the requirements shown in the following table:

Chip Retention Requirements

Quality characteristic	Test method	Requirement
Chip retention (%)	Vialit test method for aggregate in chip seals, French chip (Modified) ^a	95

^aThe asphaltic emulsion or asphalt binder must be within the field placement temperature range and application rate during specimen preparation. For asphalt binder cure the specimen for first 2 hours at 100 °F.

37-2.01B(3)(b) Precoated Aggregate

Precoating of aggregate must be performed at a central mixing plant. The plant must be authorized under the Department's *MPQP*.

When precoating aggregate, do not recombine fine materials collected in dust control systems.

Precoated aggregate must be preheated from 260 to 325 degrees F. Coat with any of the asphalts specified in the table titled "Performance Graded Asphalt Binder" in section 92. The asphalt must be from 0.5 to 1.0 percent by weight of dry aggregate. You determine the exact asphalt rate for precoating of aggregate.

Do not stockpile precoated aggregate.

37-2.01C Construction

37-2.01C(1) General

For chip seals on 2-lane, 2-way roadways, place a W8-7 (LOOSE GRAVEL) sign and a W13-1 (35) plaque at 2,000-foot maximum intervals along each side of the traveled way where aggregate is spread on a traffic lane and at public roads or streets entering the chip seal area. Place the 1st W8-7 sign in each direction where traffic first encounters the loose aggregate, regardless of which lane the aggregate is spread on. A W13-1 (35) plaque is not required where the posted speed limit is less than 40 mph.

For chip seals on freeways, expressways, and multilane conventional highways, place a W8-7, (LOOSE GRAVEL) sign and a W13-1 (35) plaque at 2,000-foot maximum intervals along the outside edge of the traveled way nearest to the lane worked on, at on ramps, and at public roads or streets entering the chip seal area. Place the 1st W8-7 sign where the aggregate starts with respect to the direction of travel on that lane. A W13-1 (35) plaque is not required where the posted speed limit is less than 40 mph.

Pilot cars must have cellular or radio contact with other pilot cars and personnel in the work zone. The maximum speed of the pilot cars conveying or controlling traffic through the traffic control zone must be 15 mph on 2-lane, two-way highways and 25 mph on multilane divided and undivided highways. Pilot cars must only use traffic lanes open to traffic.

On the days that closures are not allowed, you may use a moving closure to maintain the seal coat surface. The moving closure is only allowed during daylight hours when traffic will be the least inconvenienced and delayed. The Engineer determines the hours for the moving closure.

Maintain signs in place at each location until the final sweeping of the chip seal surface for that location is complete. Signs may be set on temporary portable supports with the W13-1 sign below the W8-7 sign or on barricades with the W13-1 sign alternating with the W8-7 sign.

Schedule chip seal activities so that the chip seals are placed on both lanes of the traveled way each work shift.

If traffic is routed over a surface where a chip seal application is intended, the chip seal must not be applied to more than half the width of the traveled way at a time, and the remaining width must be kept free of obstructions and open to traffic until the previously applied width is ready for traffic use.

Wherever maintenance sweeping of the chip seal surface is complete, place permanent traffic stripes and pavement markings within 10 days.

If you fail to place the permanent traffic stripes and pavement markings within the specified time, the Department withholds 50 percent of the estimated value of the chip seal work completed that has not received permanent traffic stripes and pavement markings.

37-2.01C(2) Equipment

Equipment for chip seals must include and comply with the following:

1. Aggregate haul trucks must have:
 - 1.1. Tailgate that discharge aggregate
 - 1.2. Device to lock onto the rear aggregate spreader hitch
 - 1.3. Dump bed that will not push down on the spreader when fully raised
 - 1.4. Dump bed that will not spill aggregate on the roadway when transferred to the spreader hopper
 - 1.5. Tarpaulin to cover precoated aggregate when haul distance exceeds 30 minutes or ambient temperature is less than 65 degrees F
2. Self-propelled aggregate spreaders must have:
 - 2.1. Aggregate hopper in the rear
 - 2.2. Belt conveyor that carries the aggregate to the front
 - 2.3. Spreading hopper capable of providing a uniform aggregate spread rate over the entire width of the traffic lane in 1 application.
3. Self-propelled power brooms must:
 - 3.1. Not be steel-tined brooms on emulsion chip seals
 - 3.2. Be capable of removing loose aggregate adjacent to barriers that prevent aggregate from being swept off the roadway, including curbs, gutters, dikes, berms, and railings
4. Pneumatic or foam filled rubber tired rollers must:
 - 4.1. Be an oscillating type at least 4 feet wide
 - 4.2. Be self-propelled and reversible
 - 4.3. Have tires of equal size, diameter, type, and ply
 - 4.4. Carry at least 3,000 lbs of load on each wheel
 - 4.5. Have tires with an air pressure of 100 ± 5 psi or be foam filled

37-2.01C(3) Surface Preparation

Before applying chip seals, cover manholes, valve and monument covers, grates, or other exposed facilities located within the area of application, using a plastic or oil resistant construction paper secured by tape or adhesive to the facility being covered. Reference the covered facilities with enough control points to relocate the facilities after the application of the chip seal.

Immediately before applying chip seals, clean the surface to receive a chip seal by removing any extraneous material affecting adhesion of the chip seal with the existing surface and drying. Use self-propelled power brooms to clean the existing pavement.

37-2.01C(4) Placement

37-2.01C(4)(a) General

Schedule the operations so that chip seals are placed on both lanes of the traveled way each work shift. At the end of the work shift, the end of the chip seals on both lanes must generally match.

37-2.01C(4)(b) Applying Asphaltic Emulsions or Asphalt Binders

Prevent spraying on existing pavement not intended for chip seals or on previously applied chip seals using a material such as building paper. Remove the material after use.

Align longitudinal joints between chip seal applications with designated traffic lanes.

For asphaltic emulsion or asphalt binder, overlap longitudinal joints by not more than 4 inches. You may overlap longitudinal joints up to 8 inches if authorized.

For areas not accessible to a truck distributor bar apply:

1. Asphaltic emulsions by hand spraying
2. Asphalt binders with a squeegee or other authorized means

You may overlap the asphaltic emulsion or asphalt binder applications before the application of aggregate at longitudinal joints.

Do not apply the asphaltic emulsion or asphalt binder unless there is sufficient aggregate at the job site to cover the asphaltic emulsion or asphalt binder.

Discontinue application of asphaltic emulsion or asphalt binder early enough to comply with lane closure requirements. Apply to 1 lane at a time and cover the lane width entirely in 1 operation.

37-2.01C(4)(c) Spreading Aggregates

37-2.01C(4)(c)(i) General

Prevent vehicles from driving on asphaltic emulsion or asphalt binder before spreading aggregate.

Spread aggregate within 10 percent of your determined rate.

Spread aggregate at a uniform rate over the full lane width in 1 application. Apply to 1 lane at a time.

Sweep excess aggregate at joints before spreading adjacent aggregate.

Operate the spreader at speeds slow enough to prevent aggregate from rolling over after dropping.

If the spreader is not moving, aggregate must not drop. If you stop spreading and aggregate drops, remove the excess aggregate before resuming activities.

37-2.01C(4)(c)(ii) Precoated Aggregate Application

During transit, cover precoated aggregate with tarpaulins if the ambient air temperature is below 65 degrees F or the haul time exceeds 30 minutes.

When applied, precoated aggregate must be from 225 to 325 degrees F.

37-2.01C(4)(d) Finishing

37-2.01C(4)(d)(i) General

Remove piles, ridges, or unevenly distributed aggregate. Repair permanent ridges, bumps, streaks or depressions in the finished surface. Spread additional aggregate and roll if aggregate is picked up by rollers or vehicles.

Chip seal joints between adjacent applications of a chip seal must be smooth, straight, uniform, and completely covered.

A coverage is 1 roller movement over the entire width of lane. A pass is 1 roller movement parallel to the chip seal application in either direction. Overlapping passes are part of the coverage being made and are not part of a subsequent coverage. Do not start a new coverage until completing the previous coverage.

Before opening to traffic, finish the chip seals in the following sequence:

1. Perform initial rolling consisting of 1 coverage with a pneumatic-tired roller
2. Perform final rolling consisting of 2 coverages with a pneumatic-tired roller
3. Sweep excess aggregate from the roadway and adjacent abutting areas
4. Apply a flush coat if specified
5. Remove covers from the facilities

37-2.01C(4)(d)(ii) Traffic Control With Pilot Car

For 2-lane 2-way roadways under 1-way traffic control, upon completion of final rolling, traffic must be controlled with pilot cars and routed over the new chip seal for a period of 2 to 4 hours before opening the lane to traffic not controlled with pilot cars.

For multilane roadways, when traffic is controlled with pilot cars, a maximum of 1 lane in the direction of travel must be open to traffic. Traffic must be controlled with pilot cars and be routed on the new chip seal surface of the lane for a minimum of 2 hours after completion of the initial sweeping and before opening the lane to traffic not controlled with pilot cars. Once traffic controlled with pilot cars is routed over the chip seal at a particular location, continuous control must be maintained at that location until the chip seal placement and sweeping on adjacent lanes to receive a chip seal is completed.

37-2.01C(4)(d)(iii) Sweeping

Sweeping must be performed after the chip seal has set and there is no damage or dislodging of aggregate from the chip seal surface. As a minimum, sweeping is required at the following times:

1. On 2-lane 2-way roadways, from 2 to 4 hours after traffic, controlled with pilot cars, has been routed on the chip seal
2. On multilane roadways, from 2 to 4 hours after aggregate have been placed
3. In addition to previous sweeping, perform final sweeping immediately before opening any lane to public traffic, not controlled with pilot cars

37-2.01C(4)(d)(iv) Excess Aggregate

Dispose of excess aggregate. If ordered, salvaging and stockpiling of excess aggregate is change order work.

37-2.01C(4)(e) Chip Seal Maintenance

Perform sweeping on the morning following the application of aggregate on any lane that has been open to traffic not controlled with pilot cars and before starting any other activities.

Chip seal surfaces must be maintained for 4 consecutive days from the day aggregate is applied. Maintenance must include sweeping to maintain a surface free of loose aggregate and to prevent formation of corrugations. Sweeping must not dislodge aggregate set in asphaltic emulsion or asphalt binder.

After 4 consecutive days, excess aggregate must be removed from the paved areas.

37-2.01D Payment

If there is no bid item for traffic control system, furnishing and using a pilot car is included in the various items of the work involved in applying the chip seal.

The payment quantity for precoated aggregate is the weight measured after the aggregate is preheated and precoated with asphalt binder.

If recorded batch weights are printed automatically, the payment quantity for aggregate is the weight determined from the printed batch weights if:

1. Total weight for the precoated aggregate per batch is printed
2. Total asphalt binder weight per batch is printed
3. Zero tolerance weight is printed before weighing the first batch and after weighing the last batch for each truckload
4. Time, date, mix number, load number, and truck identification are correlated with a load slip
5. Copy of the recorded batch weights is certified by a licensed weighmaster

37-2.02 ASPHALTIC EMULSION CHIP SEALS

37-2.02A General

37-2.02A(1) Summary

Section 37-2.02 includes specifications for applying asphaltic emulsion chip seals. An asphaltic emulsion chip seal includes applying an asphaltic emulsion, followed by aggregate, and then a flush coat.

A double asphaltic emulsion chip seal is the application of an asphaltic emulsion followed by aggregate, applied twice in sequence and then a flush coat.

37-2.02A(2) Definitions

Reserved

37-2.02A(3) Submittals

Immediately after sampling, submit two 1-quart plastic containers of asphaltic emulsion taken in the presence of the Engineer. Samples must be submitted in insulated shipping container.

37-2.02A(4) Quality Assurance**37-2.02A(4)(a) General**

Reserved

37-2.02A(4)(b) Quality Control**37-2.02A(4)(b)(i) General**

Reserved

37-2.02A(4)(b)(ii) Asphaltic Emulsions

Circulate asphaltic emulsion in the distributor truck before sampling. Take samples from the distributor truck at mid load or from a sampling tap or thief. Before taking samples, draw and dispose of 1 gallon. In the presence of the Engineer, take two 1-quart samples in a plastic container with lined sealed lid for acceptance testing.

For asphaltic emulsion, the authorized laboratory must perform quality control sampling and testing at the specified frequency and location for the following quality characteristics:

Asphaltic Emulsion

Quality characteristic	Test method	Minimum sampling and testing frequency	Sampling location
Saybolt Furol Viscosity, at 25 °C (Saybolt Furol seconds)	AASHTO T 59	Minimum 1 per day per delivery truck	Distributor truck
Sieve Test (%)			
Storage stability, 1 day (%)			
Residue by distillation (%)			
Particle charge ^a			
Tests on Residue from Distillation Test:			
Penetration, 25 °C	AASHTO T 49	Minimum 1 per day per delivery truck	Distributor truck
Ductility	AASHTO T 51		
Solubility in trichloroethylene	AASHTO T 44		

^aIf the result of the particle charge is inconclusive, the asphaltic emulsion must be tested for pH under ASTM E70. Grade QS1h asphaltic emulsion must have a minimum pH of 7.3. Grade CQS1h asphaltic emulsion must have a maximum pH of 6.7.

37-2.02A(4)(c) Department Acceptance

Aggregate acceptance is based on the Department's sampling and testing for compliance with the requirements shown in the following table:

Aggregate Gradation Acceptance Criteria

Quality characteristic	Test method	Requirement		
		3/8"	5/16"	1/4"
Gradation (% passing by weight)	California Test 202	3/8"	5/16"	1/4"
Sieve size:		--	--	--
3/4"		100	--	--
1/2"		85-100	100	100
3/8"		0-15	0-50	60-85
No. 4		0-5	0-15	0-25
No. 8		--	0-5	0-5
No. 16		--	0-3	0-3
No. 30		0-2	0-2	0-2
No. 200				

37-2.02B Materials**37-2.02B(1) General**

Reserved

37-2.02B(2) Asphaltic Emulsions

Reserved

37-2.02B(3) Aggregate

Aggregate gradation for an asphaltic emulsion chip seal must comply with the requirements shown in the following table:

Quality characteristic	Test method	Requirement		
Gradation (% passing by weight)	California Test 202	3/8"	5/16"	1/4"
Sieve size:		--	--	--
3/4"		100	--	--
1/2"		85–100	100	100
3/8"		0–15	0–50	60–85
No. 4		0–5	0–15	0–25
No. 8		--	0–5	0–5
No. 16		--	0–3	0–3
No. 30		0–2	0–2	0–2
No. 200				

37-2.02C Construction

37-2.02C(1) General

Reserved

37-2.02C(2) Asphaltic Emulsions

Asphaltic emulsions must be applied within the application rate ranges shown in the following table:

Aggregate gradation	Application rate range (gal/sq yd)
3/8"	0.30–0.45
5/16"	0.25–0.35
1/4"	0.20–0.30

For double asphaltic emulsion chip seals, the asphaltic emulsions must be applied within the application rates shown in the following table:

Double chip seals	Application rate range (gal/sq yd)
1st application	0.30–0.45
2nd application	0.20–0.30

When applied, the temperature of the asphaltic emulsions must be from 130 to 180 degrees F.

Apply asphaltic emulsions when the ambient air temperature is from 65 to 110 degrees F and the pavement surface temperature is at least 80 degrees F.

Do not apply asphaltic emulsions when weather forecasts predict the ambient air temperature will fall below 39 degrees F within 24 hours after application.

37-2.02C(3) Spreading Aggregates

Aggregate must be spread within the spread rate ranges shown in the following table:

Aggregate Spread Rates

Aggregate gradation	Spread rate range (lb/sq yd)
3/8"	20–30
5/16"	16–25
1/4"	12–20

For double asphaltic emulsion chip seals, aggregate must be spread within the spread rate ranges shown in the following table:

Aggregate Spread Rates

Double chip seal	Spread rate range (lb/sq yd)
1st application	23–30
2nd application	12–20

Remove excess aggregate on the 1st application before the 2nd application of asphaltic emulsion.

You may stockpile aggregate for asphaltic emulsion chip seals if you prevent contamination. Aggregate must have a damp surface at spreading. If water visibly separates from the aggregate, do not spread. You may re-dampen aggregate in the delivery vehicle.

Spread aggregate before an asphaltic emulsion sets or breaks.

Do not spread aggregate more than 2,500 feet ahead of the completed initial rolling.

37-2.02D Payment

Not Used

37-2.03 POLYMER MODIFIED ASPHALTIC EMULSION CHIP SEALS

37-2.03A General

37-2.03A(1) Summary

Section 37-2.03 includes specifications for applying polymer modified asphaltic emulsion chip seals. A polymer modified asphaltic emulsion chip seal includes applying a polymer modified asphaltic emulsion, followed by aggregate, and then a flush coat.

A double polymer modified asphaltic emulsion chip seal is the application of a polymer modified asphaltic emulsion followed by aggregate, applied twice in sequence and then a flush coat.

37-2.03A(2) Definitions

Reserved

37-2.03A(3) Submittals

Immediately after sampling, submit two 1-quart cans of polymer modified asphaltic emulsion taken in the presence of the Engineer. A sample must be submitted in an insulated shipping container.

37-2.03A(4) Quality Assurance

37-2.03A(4)(a) General

Reserved

37-2.03A(4)(b) Quality Control

37-2.03A(4)(b)(i) General

Reserved

37-2.03A(4)(b)(ii) Polymer Modified Asphaltic Emulsions

Circulate polymer modified asphaltic emulsions in the distributor truck before sampling. Take samples from the distributor truck at mid load or from a sampling tap or thief. Before taking samples, draw and dispose of 1 gallon. In the presence of the Engineer, take two 1-quart samples for acceptance testing.

For polymer modified asphaltic emulsions, the authorized laboratory must perform quality control sampling and testing at the specified frequency and location for the following quality characteristics:

Polymer Modified Asphaltic Emulsion

Quality characteristic	Test method	Minimum sampling and testing frequency	Sampling location
Saybolt Furol Viscosity, at 50 °C (Saybolt Furol seconds)	AASHTO T 59	Minimum 1 per day per delivery truck	Distributor truck
Settlement, 5 days (max, %)			
Storage stability test, 1 day (max, %)			
Sieve test (max, %)			
Demulsibility (min, %)			
Particle charge			
Ash content (max, %)			
Residue by evaporation (min, %)	California Test 331		
Tests on residue from evaporation test:			
Penetration, 25 °C	AASHTO T 49	Minimum 1 per day per delivery truck	Distributor truck
Penetration, 4 °C, 200g for 60 seconds	AASHTO T 49		
Ductility, 25 °C (min, mm)	AASHTO T 51		
Torsional recovery (min, %)	California Test 332		
Ring and Ball Softening Point (min, °F)	AASHTO T 53		

37-2.03A(4)(c) Department Acceptance

Aggregate acceptance is based on the Department’s sampling and testing for compliance with the requirements shown in the following table:

Aggregate Gradation Acceptance Criteria

Quality characteristic	Test method	Requirement		
		3/8"	5/16"	1/4"
Gradation (% passing by weight)	California Test 202	3/8"	5/16"	1/4"
Sieve size:				
3/4"		--	--	--
1/2"		100	--	--
3/8"		85–100	100	100
No. 4		0–15	0–50	60–85
No. 8		0–5	0–15	0–25
No. 16		--	0–5	0–5
No. 30		--	0–3	0–3
No. 200		0–2	0–2	0–2

37-2.03B Materials

37-2.03B(1) General

Reserved

37-2.03B(2) Polymer Modified Asphaltic Emulsions

A polymer modified asphaltic emulsion must include elastomeric polymer.

A polymer modified asphaltic emulsion must be Grade PMRS2, PMRS2h, PMCRS2, or PMCRS2h. Polymer content in percent by weight does not apply.

A polymer modified asphaltic emulsion must comply with section 94 and the quality characteristic requirements in the following table:

Polymeric Asphaltic Emulsion

Quality characteristic	Test method	Requirement
Penetration, 4 °C, 200g for 60 seconds (min)	AASHTO T 49	6
Ring and Ball Softening Point (min, °F)	AASHTO T 53	135

37-2.03B(3) Aggregate

The aggregate gradation for a polymer modified asphaltic emulsion chip seal must comply with the requirements shown in the following table:

Asphaltic Emulsion Chip Seal Aggregate Gradation

Quality characteristic	Test method	Requirement		
Gradation (% passing by weight) Sieve Size	California Test 202	3/8"	5/16"	1/4"
3/4"		--	--	--
1/2"		100	--	--
3/8"		85–100	100	100
No. 4		0–15	0–50	60–85
No. 8		0–5	0–15	0–25
No. 16		--	0–5	0–5
No. 30		--	0–3	0–3
No. 200		0–2	0–2	0–2

37-2.03C Construction

Polymer modified asphaltic emulsions must be applied within the application rate ranges shown in the following table:

Polymer Modified Asphaltic Emulsion Application Rates

Aggregate gradation	Application rate range (gal/sq yd)
3/8"	0.30–0.45
5/16"	0.25–0.35
1/4"	0.20–0.30

For double polymer modified asphaltic emulsion chip seals, polymer modified asphaltic emulsions must be applied within the application rates shown in the following table:

Polymer Modified Asphaltic Emulsion Application Rates

Double application	Application rate range (gal/sq yd)
1st application	0.30–0.45
2nd application	0.20–0.30

Apply polymer modified asphaltic emulsions when the ambient air temperature is from 60 to 105 degrees F and the pavement surface temperature is at least 80 degrees F.

Do not apply polymer modified asphaltic emulsions when weather forecasts predict the ambient air temperature will fall below 39 degrees F within 24 hours after application.

Aggregate must be spread within the spread rate ranges shown in the following table:

Aggregate Spread Rates

Chip seal type	Spread rate range (lb/sq yd)
3/8"	20–30
5/16"	16–25
1/4"	12–20

For double chip seals, aggregate must be spread within spread rate ranges shown in the following table:

Aggregate Spread Rates

Double application	Spread rate range (lb/sq yd)
1st application	23–30
2nd application	12–20

Remove excess aggregate on the 1st application before the 2nd application of asphaltic emulsion.

You may stockpile aggregate for the polymer modified asphaltic emulsion chip seals if you prevent contamination. Aggregate must have damp surfaces at spreading. If water visibly separates from the aggregate, do not spread. You may redampen aggregate in the delivery vehicle.

Spread aggregate before the polymer modified asphaltic emulsion sets or breaks.

Do not spread aggregate more than 2,500 feet ahead of the completed initial rolling.

37-2.03D Payment

Not Used

37-2.04 ASPHALT RUBBER BINDER CHIP SEALS

37-2.04A General

37-2.04A(1) Summary

Section 37-2.04 includes specifications for applying asphalt rubber binder chip seals.

An asphalt rubber binder chip seal consists of applying asphalt rubber binder followed by heated aggregate precoated with asphalt binder followed by a flush coat.

37-2.04A(2) Definitions

crumb rubber modifier: Combination of ground or granulated high natural scrap tire crumb rubber and scrap tire crumb rubber derived from waste tires described in Pub Res Code § 42703.

descending viscosity reading: Subsequent viscosity reading at least 5 percent lower than the previous viscosity reading.

high natural scrap tire crumb rubber: Material containing 40 to 48 percent natural rubber.

scrap tire crumb rubber: Any combination of vehicle tires or tire buffing.

37-2.04A(3) Submittals

At least 5 business days before use, submit the permit issued by the local air district for asphalt rubber binder field blending equipment and application equipment. If an air quality permit is not required by the local air district for producing asphalt rubber binder, submit verification from the local air district that an air quality permit is not required.

For each delivery of asphalt rubber binder ingredients to the job site, submit a certificate of compliance with a copy of the specified test results.

Submit a certified volume or weight slip for each delivery of asphalt rubber binder ingredients and asphalt rubber binder.

Submit a SDS for each asphalt rubber binder ingredient and the asphalt rubber binder.

At least 15 days before use, submit:

1. Samples of each asphalt rubber binder ingredient:
 - 1.1. 2 lbs of scrap tire crumb rubber
 - 1.2. 2 lbs of high natural scrap tire crumb rubber
 - 1.3. Two 1-quart cans of base asphalt binder
 - 1.4. Two 1-quart cans of asphalt modifier
2. Asphalt rubber binder formulation and data as follows:
 - 2.1. For asphalt modifier, include:
 - 2.1.1. Source of asphalt modifier
 - 2.1.2. Type of asphalt modifier
 - 2.1.3. Percentage of asphalt modifier by weight of asphalt binder
 - 2.1.4. Percentage of combined asphalt binder and asphalt modifier by weight of asphalt rubber binder
 - 2.1.5. Test results for the specified quality characteristics
 - 2.2. For crumb rubber modifier, include:
 - 2.2.1. Each source and type of scrap tire crumb rubber and high natural scrap tire crumb rubber
 - 2.2.2. Percentage of scrap tire crumb rubber and high natural scrap tire crumb rubber by total weight of asphalt rubber binder
 - 2.2.3. Test results for the specified quality characteristics
 - 2.3. For asphalt rubber binder, include minimum reaction time and temperature

Immediately after sampling, submit five 1-quart cans of asphalt rubber binder taken in the presence of the Engineer. Sample must be submitted in insulated shipping containers.

Submit notification 15 minutes before each viscosity test or submit a schedule of testing times.

Submit the log of asphalt rubber binder descending viscosity test results within 1 business day after sampling.

Submit asphalt rubber binder quality control viscosity test results within 1 business day after sampling.

37-2.04A(4) Quality Assurance

37-2.04A(4)(a) General

The equipment used in producing asphalt rubber binder and the equipment used in spreading asphalt rubber binder must be permitted for use or exempted by the local air district.

37-2.04A(4)(b) Quality Control

37-2.04A(4)(b)(i) General

Reserved

37-2.04A(4)(b)(ii) Asphalt Modifiers

For asphalt modifiers, the authorized laboratory must perform quality control sampling and testing at the specified frequency for the following quality characteristics:

Asphalt Modifier for Asphalt Rubber Binder		
Quality characteristic	Test method	Frequency
Viscosity	ASTM D445	1 per shipment
Flash point	ASTM D92	
Molecular Analysis:		
Asphaltenes	ASTM D2007	1 per shipment
Aromatics	ASTM D2007	

37-2.04A(4)(b)(iii) Crumb Rubber Modifiers

Sample and test scrap tire crumb rubber and high natural scrap tire crumb rubber separately.

Perform quality control sampling and testing at the specified frequency for the following quality characteristics:

Crumb Rubber Modifier

Quality characteristic	Test method	Frequency
Scrap tire crumb rubber gradation	California Test 385	1 per 10,000
High natural scrap tire crumb rubber gradation	California Test 385	1 per 3,400 lb
Wire in CRM	California Test 385	1 per 10,000 lb
Fabric in CRM	California Test 385	
CRM particle length	--	
CRM specific gravity	California Test 208	
Natural rubber content in high natural scrap tire crumb rubber	ASTM D297	1 per 3,400 lb

37-2.04A(4)(b)(iv) Asphalt Rubber Binders

For asphalt rubber binders, the authorized laboratory must perform quality control sampling and testing at the specified frequency and location for the following quality characteristics:

Asphalt Rubber Binder Quality Control Requirements

Quality characteristic	Test method	Sampling location	Frequency
Descending viscosity ^a at 375 °F (Pa•s x 10 ⁻³)	ASTM D7741	Reaction vessel	1 per lot ^b
Viscosity at 375 °F (Pa•s x 10 ⁻³)	ASTM D7741	Distribution truck	15 minutes before use per lot ^b
Cone penetration at 25 °C (0.10 mm)	ASTM D217	Distribution truck	1 per lot ^b
Resilience at 25 °C (% rebound)	ASTM D5329		
Softening point (°C)	ASTM D36		

^aStart taking viscosity readings at least 45 minutes after adding crumb rubber modifier and continue taking viscosity readings every 30 minutes until 2 consecutive descending viscosity readings have been obtained and the final viscosity complies with the specification requirement.

^bA lot is defined in the *MPQP*.

Retain samples from each lot. Test samples for cone penetration, resilience, and softening point for the first 3 lots and if all 3 lots pass, the testing frequency may be reduced to once for every 3 lots.

If QC test results indicate that the asphalt rubber binder does not comply with the specifications, take corrective action and notify the Engineer.

37-2.04A(4)(c) Department Acceptance

37-2.04A(4)(c)(i) General

Reserved

37-2.04A(4)(c)(ii) Asphalt Modifiers

The Department accepts asphalt modifier based on compliance with the requirements shown in the following table:

Asphalt Modifier for Asphalt Rubber Binder

Quality characteristic	Test method	Requirement
Viscosity at 100 °C (m ² /s x 10 ⁻⁶)	ASTM D445	X ± 3 ^a
Flash point (min, °C)	ASTM D92	207
Molecular Analysis:		
Asphaltenes (max, % by mass)	ASTM D2007	0.1
Aromatics (min, % by mass)	ASTM D2007	55

^aThe symbol "X" is the asphalt modifier viscosity.

37-2.04A(4)(c)(iii) Crumb Rubber Modifiers

Scrap tire CRM and high natural CRM are sampled and tested separately.

The Department accepts scrap tire CRM and high natural CRM based on compliance with the requirements shown in the following table:

Crumb Rubber Modifier for Asphalt Rubber Binder

Quality characteristic	Test method	Requirement
Wire in CRM (max, %)	California Test 385	0.01
Fabric in CRM (max, %)	California Test 385	0.05
CRM particle length (max, in)	--	3/16
CRM specific gravity	California Test 208	1.1–1.2
Natural rubber content in high natural CRM (%)	ASTM D297	40.0–48.0

The Department accepts CRM gradation based on the requirements shown in the following table:

Crumb Rubber Modifier Gradation Requirements

Quality characteristic	Test method	Requirement			
		Scrap tire crumb rubber		High natural scrap tire crumb rubber	
Gradation (% passing by weight) Sieve size:	California Test 385	Operating range	Contract compliance	Operating range	Contract compliance
No. 8		100	100	--	--
No. 10		95–100	90–100	100	100
No. 16		35–85	32–88	92–100	85–100
No. 30		2–25	1–30	25–95	20–98
No. 50		0–10	0–15	6–35	2–40
No. 100		0–5	0–10	0–7	0–10
No. 200		0–2	0–5	0–3	0–5

If a test result for CRM gradation does not comply with the specifications, the Department deducts the corresponding amount for each gradation test as shown in the following table:

Material	Gradation test result ^a	Deduction
Scrap tire crumb rubber	Operating range < TR < Contract compliance	\$250
Scrap tire crumb rubber	TR > Contract compliance	\$1,100
High natural scrap tire crumb rubber	Operating range < TR < Contract compliance	\$250
High natural scrap tire crumb rubber	TR > Contract compliance	\$600

^aTest Result = TR

Each gradation test for scrap tire crumb rubber represents 10,000 lb or the quantity used in that day's production, whichever is less.

Each gradation test for high natural scrap tire crumb rubber represents 3,400 lb or the quantity used in that day's production, whichever is less.

37-2.04A(4)(c)(iv) Asphalt Rubber Binders

For Department acceptance testing, take a sample of asphalt rubber binder in the Engineer's presence every 5 lots or once a day, whichever is greater. Each sample must be in five 1-quart cans with an open top and friction lid.

For an asphalt rubber binder, acceptance is based on the Department's sampling and testing for compliance with the requirements shown in the following table:

Asphalt Rubber Binder

Quality characteristic	Test method	Requirement
Cone penetration at 25 °C (0.10 mm)	ASTM D217	25–60
Resilience at 25 °C (% rebound)	ASTM D5329	18–50
Softening point (°C)	ASTM D36	55–88
Viscosity at 375 °F (Pa•s x 10 ⁻³) ^a	ASTM D7741	1,500–2,500

^aPrepare sample for viscosity test under California Test 388.

37-2.04A(4)(c)(v) Precoated Aggregate

The Department accepts precoated aggregate based on compliance with the requirements shown in the following table:

Precoated Aggregate Gradation Acceptance Criteria

Quality Characteristic	Test method	Requirement
1/2" gradation (% passing by weight)	California Test 202	
Sieve size:		
3/4"		100
1/2"		85–90
3/8"		0–30
No. 4		0–5
No. 8		--
No. 200	0–1	
3/8" gradation (% passing by weight)	California Test 202	
Sieve size:		
3/4"		100
1/2"		95–100
3/8"		70–85
No. 4		0–15
No. 8		0–5
No. 200	0–1	

37-2.04B Materials

37-2.04B(1) General

Reserved

37-2.04B(2) Asphalt Binders

Asphalt binder used as the base binder for asphalt rubber binder must comply with the specifications for asphalt binder. Do not modify asphalt binder with polymer.

37-2.04B(3) Asphalt Modifiers

An asphalt modifier must be a resinous, high flash point, and aromatic hydrocarbon. An asphalt modifier must comply with the requirements shown in the following table:

Asphalt Modifier for Asphalt Rubber Binder

Quality characteristic	Test method	Requirement
Viscosity at 100 °C (m ² /s x 10 ⁻⁶)	ASTM D445	X ± 3 ^a
Flash point (min, CL.O.C., °C)	ASTM D92	207
Molecular analysis:		
Asphaltenes by mass (max, %)	ASTM D2007	0.1
Aromatics by mass (min, %)	ASTM D2007	55

^aX denotes the proposed asphalt modifier viscosity from 19 to 36. A change in X requires a new asphalt rubber binder submittal.

37-2.04B(4) Crumb Rubber Modifiers

The CRM to be used must be on the Authorized Materials List for crumb rubber modifier.

The CRM must be ground or granulated at ambient temperature.

Scrap tire crumb rubber and high natural scrap tire crumb rubber must be delivered to the asphalt rubber binder production site in separate bags.

Steel and fiber must be separated. If steel and fiber are cryogenically separated, it must occur before grinding and granulating. Cryogenically-produced CRM particles must be large enough to be ground or granulated.

The CRM must be dry, free-flowing particles that do not stick together. A maximum of 3 percent calcium carbonate or talc by weight of CRM may be added. The CRM must not cause foaming when combined with the asphalt binder and asphalt modifier.

The CRM must comply with the requirements shown in the following table:

Crumb Rubber Modifier for Asphalt Rubber Binder

Quality characteristic	Test method	Requirement
Wire in CRM (max, %)	California Test 385	0.01
Fabric in CRM (max, %)	California Test 385	0.05
CRM particle length (max, in)	--	3/16
CRM specific gravity	California Test 208	1.1–1.2

The CRM must comply with the requirements shown in the following table:

Crumb Rubber Modifier Requirements

Quality characteristic	Test method	Requirement	
		Scrap tire crumb rubber	High natural scrap tire crumb rubber
Acetone extract (%)	ASTM D297	6.0–16.0	4.0–16.0
Rubber hydrocarbon (min, %)		42.0–65.0	50.0
Natural rubber content (%)		22.0–39.0	40.0–48.0
Carbon black content (%)		28.0–38.0	--
Ash content (max, %)		8.0	--

Scrap tire crumb rubber gradation must comply with the gradation requirements shown in the following table:

Scrap Tire Crumb Rubber Gradation

Quality characteristic	Test method	Requirement		
		Gradation limit	Operating range	Contract compliance
Gradation (% passing by weight) Sieve size:	California Test 385			
No. 8		100	100	100
No. 10		98–100	95–100	90–100
No. 16		45–75	35–85	32–88
No. 30		2–20	2–25	1–30
No. 50		0–6	0–10	0–15
No. 100		0–2	0–5	0–10
No. 200		0	0–2	0–5

High natural scrap tire crumb rubber gradation must comply with the gradation requirements shown in the following table:

High Natural Scrap Tire Crumb Rubber Gradation

Quality characteristic	Test method	Requirement		
		Gradation limit	Operating range	Contract compliance
Gradation (% passing by weight) Sieve size:	California Test 385			
No. 10		100	100	100
No. 16		95–100	92–100	85–100
No. 30		35–85	25–95	20–98
No. 50		10–30	6–35	2–40
No. 100		0–4	0–7	0–10
No. 200		0–1	0–3	0–5

37-2.04B(5) Asphalt Rubber Binders

An asphalt rubber binder must be a combination of:

1. Asphalt binder
2. Asphalt modifier
3. Crumb rubber modifier

Asphalt rubber binder blending equipment must be authorized under the Department's *MPQP*.

The blending equipment must allow the determination of weight percentages of each asphalt rubber binder ingredient.

An asphalt rubber binder must be 79 ± 1 percent by weight asphalt binder and 21 ± 1 percent by weight of CRM. The minimum percentage of CRM must be 20.0 percent and lower values must not be rounded up.

The CRM must be 75 ± 2 percent by weight scrap tire crumb rubber and 25 ± 2 percent by weight high natural scrap tire crumb rubber.

An asphalt modifier and asphalt binder must be blended at the production site. An asphalt modifier must be from 2.5 to 6.0 percent by weight of the asphalt binder in the asphalt rubber binder. The asphalt rubber binder supplier determines the exact percentage.

If blended before adding CRM, the asphalt binder must be from 375 to 440 degrees F when an asphalt modifier is added and the mixture must circulate for at least 20 minutes. An asphalt binder, asphalt modifier, and CRM may be proportioned and combined simultaneously.

The blend of an asphalt binder and an asphalt modifier must be combined with the CRM at the asphalt rubber binder production site. The asphalt binder and asphalt modifier blend must be from 375 to 440 degrees F when the CRM is added. Combined ingredients must be allowed to react at least 45 minutes at temperatures from 375 to 425 degrees F except the temperature must be at least 10 degrees F below the flash point of the asphalt rubber binder.

After reacting, the asphalt rubber binder must comply with the requirements shown in the following table:

Asphalt Rubber Binder

Quality characteristic	Test method	Requirement
Cone penetration at 25 °C (0.10 mm)	ASTM D217	25–60
Resilience at 25 °C (% rebound)	ASTM D5329	18–50
Softening point (°C)	ASTM D36	55–88
Viscosity at 375 °F ($\text{Pa}\cdot\text{s} \times 10^{-3}$) ^a	ASTM D7741	1,500–2,500

^aPrepare sample for viscosity test under California Test 388.

Maintain asphalt rubber binder at a temperature from 375 to 415 degrees F.

Stop heating unused asphalt rubber binder 4 hours after the 45-minute reaction period. Reheating asphalt rubber binder that cools below 375 degrees F is a reheat cycle. Do not exceed 2 reheat cycles. If reheating, the asphalt rubber binder must be from 375 to 415 degrees F before use.

During reheating, you may add CRM. The CRM must not exceed 10 percent by weight of the asphalt rubber binder. Allow added CRM to react for at least 45 minutes. Reheated asphalt rubber binder must comply with the specifications for asphalt rubber binder.

37-2.04B(6) Precoated Aggregate

Before precoating with asphalt binder, aggregate for an asphalt rubber binder chip seal must comply with the gradation requirements shown in the following table:

Asphalt Rubber Binder Chip Seal Aggregate Gradation

Quality characteristic	Test method	Requirement	
Gradation (% passing by weight)	California Test 202	1/2"	3/8"
Sieve size:			
3/4"		100	100
1/2"		85–90	95–100
3/8"		0–30	70–85
No. 4		0–5	0–15
No. 8		--	0–5
No. 200		0–1	0–1

37-2.04C Construction

37-2.04C(1) General

Reserved

37-2.04C(2) Equipment

Distributor trucks must be equipped with:

1. Mixing and heating unit
2. Observation platform on the rear of the truck for an observer on the platform to see the nozzles and unplug them if needed

37-2.04C(3) Asphalt Rubber Binder Application

Apply the asphalt rubber binder when the ambient temperature is from 60 to 105 degrees F and the pavement surface temperature is at least 55 degrees F.

Do not apply the asphalt rubber binder unless enough aggregate is available at the job site to cover the asphalt rubber binder within 2 minutes. Intersections, turn lanes, gore points, and irregular areas must be covered within 15 minutes.

Do not apply asphalt rubber binder when pavement is damp or during high wind conditions. If authorized, you may adjust the distributor bar height and distribution speed and use shielding equipment during high wind conditions.

When applied, the temperature of the asphalt rubber binder must be from 385 to 415 degrees F.

Apply the asphalt rubber binder at a rate from 0.55 to 0.65 gal/sq yd. You may reduce the application rate by 0.050 gal/sq yd in the wheel paths.

37-2.04C(4) Precoated Aggregate Spreading

Spread aggregate at a rate from 28 to 40 lb/sq yd. Do not spread aggregate more than 200 feet ahead of the completed initial rolling.

37-2.04C(5) Rolling and Sweeping

Perform initial rolling within 90 seconds of spreading aggregate. If authorized for final rolling, you may use a steel-wheeled roller weighing from 8 to 10 tons in static mode only.

Perform a final sweeping before Contract acceptance. The final sweeping must not dislodge aggregate.

37-2.04D Payment

Asphalt rubber binder is measured as specified for asphalt binder.

37-2.05 STRESS ABSORBING MEMBRANE INTERLAYERS

37-2.05A General

Section 37-2.05 includes specifications for placing stress absorbing membrane interlayers (SAMI).

Comply with section 37-2.04 except a flush coat is not required.

Traffic must not be allowed on a SAMI.

37-2.05B Materials

For a SAMI, aggregate must comply with the 3/8-inch gradation.

37-2.05C Construction

If a SAMI is overlaid in the same work shift, section 37-2.01C(4)(e) does not apply.

Final sweeping is not required for a SAMI.

37-2.05D Payment

Not Used

37-2.06 MODIFIED ASPHALT BINDER CHIP SEALS

Reserved

37-2.07 SCRUB SEALS

Reserved

37-3 SLURRY SEALS AND MICRO-SURFACINGS

37-3.01 GENERAL

37-3.01A General

37-3.01A(1) Summary

Section 37-3.01 includes general specifications for applying slurry seals and micro-surfacings.

37-3.01A(2) Definitions

Reserved

37-3.01A(3) Submittals

At least 15 days before starting placement of a slurry seal or micro-surfacing, submit:

1. Samples for:
 - 1.1. Asphaltic emulsion slurry seal, two 1-quart wide mouth plastic containers with screw top lid of asphaltic emulsion
 - 1.2. Polymer modified asphaltic emulsion slurry seal, two 1-quart wide mouth plastic containers with screw top lid of polymer modified asphaltic emulsion
 - 1.3. Micro-surfacing, two 1-quart wide mouth plastic containers with screw top lid of micro-surfacing emulsion
2. Asphaltic emulsion, polymer modified asphaltic emulsion, or micro-surfacing emulsion data as follows:
 - 2.1. Supplier and Type/Grade of asphaltic emulsion
 - 2.2. Type of modifier polymer for polymer modified asphaltic emulsion or micro-surfacing emulsion
 - 2.3. Copy of the specified test results for asphaltic emulsion, polymer modified asphaltic emulsion, or micro-surfacing emulsion
3. 50 lb of aggregate
4. Aggregate test results for the followings:
 - 4.1. Gradation
 - 4.2. Los Angeles Rattler
 - 4.3. Percent of crushed particles

- 4.4 Sand equivalent
- 4.5 Durability

At least 10 days before starting placement of a slurry seal or micro-surfacing, submit a laboratory report of test results and the proposed mix design from an authorized laboratory. The authorized laboratory must sign the laboratory report and mix design.

The report must include:

1. Test results used in the mix design compared with specification requirements
2. Proportions based on the dry weight of aggregate, including ranges, for:
 - 2.1. Aggregate
 - 2.2. Water
 - 2.3. Additives
 - 2.4. Mineral filler
 - 2.5. Slurry seal emulsion or micro-surfacing emulsion residual asphalt content
3. Recommended changes to the proportions based on heating the mixture to 100 degrees F and mixing for 60 seconds, if atmospheric temperatures during application will be 90 degrees F or above, for:
 - 3.1. Water
 - 3.2. Additives
 - 3.3. Mineral filler
4. Quantitative moisture effects on the aggregate's unit weight determined under ASTM C29M

If the mix design consists of the same materials covered by a previous laboratory report, you may submit the previous laboratory report that must include material testing data performed within the previous 12 months for authorization.

If you change any of the materials in the mix design, submit a new mix design and laboratory report at least 10 days before starting slurry seal or micro-surfacing work.

Submit a certificate of compliance as specified for asphaltic emulsion in section 94-1.01C with each shipment of asphaltic emulsion, polymer modified asphaltic emulsion or micro-surfacing emulsion.

Submit quality control test results for the quality characteristics within the reporting times allowance after sampling shown in the following table:

Quality Control Test Reporting Requirements

Quality characteristic	Maximum reporting time allowance
Los Angeles Rattler loss (max, %)	2 business days
Percent of crushed particles (min, %)	2 business days
Durability (min)	2 business days
Resistance of fine aggregate to degradation by abrasion in the Micro-Deval Apparatus (% loss by weight)	2 business days
Gradation (% passing by weight)	48 hours
Sand equivalent (min)	48 hours
Moisture content (%)	48 hours

Within 3 days after taking asphaltic emulsion, polymer modified asphaltic emulsion or micro-surfacing emulsion quality control samples, submit the authorized laboratory's test results.

37-3.01A(4) Quality Assurance

37-3.01A(4)(a) General

Your authorized laboratory must be able to perform International Slurry Surfacing Association tests and mix design.

37-3.01A(4)(b) Quality Control

37-3.01A(4)(b)(i) General

Reserved

37-3.01A(4)(b)(ii) Aggregate

For aggregate, the authorized laboratory must perform sampling and testing at the specified frequency and location for the following quality characteristics:

Aggregate Quality Control

Quality characteristic	Test method	Minimum sampling and testing frequency	Location of sampling
Los Angeles Rattler loss (max, %) At 500 revolutions	California Test 211	1st day of production	See California Test 125
Percent of crushed particles (min, %)	AASHTO T 335	1st day of production	See California Test 125
Sand equivalent (min)	California Test 217	1 per working stockpile per day	See California Test 125
Resistance of fine aggregate to degradation by abrasion in the Micro-Deval Apparatus (% loss by weight)	ASTM D7428	1 per working stockpile per day	See California Test 125
Gradation (% passing by weight)	California Test 202	1 per working stockpile per day	See California Test 125
Moisture content, from field stockpile (%)	AASHTO T 255 ^a	1 per working stockpile per day	See California Test 125

^aTest aggregate moisture at field stockpile every 2 hours if you are unable to maintain the moisture content to within a maximum daily variation of ± 0.5 percent.

37-3.01A(4)(b)(iii) Slurry Seals and Micro-surfacings

Reserved

37-3.01A(4)(c) Department Acceptance

Slurry Seal and micro-surfacing acceptance is based on:

1. Visual inspection for the following:
 - 1.1. Uniform surface texture throughout the work limits.
 - 1.2. Marks in the surface:
 - 1.2.1. Up to 4 marks in the completed slurry seal or micro-surfacing surface that are up to 1 inch wide and up to 6 inches long per 1000 square feet of slurry seal or micro-surfacing placed.
 - 1.2.2. No marks in the completed slurry seal or micro-surfacing surface that are over 1 inch wide or 6 inches long.
 - 1.3. Excessive raveling consisting of the separation of the aggregate from the asphaltic emulsion, polymer modified asphaltic emulsion or micro-surfacing emulsion.
 - 1.4. Bleeding consists of the occurrence of a film of asphaltic material on the surface of the slurry seal or micro-surfacing.
 - 1.5. Delaminating of slurry seal or micro-surfacing from the existing pavement.
 - 1.6. Rutting or wash-boarding.
2. Department's sampling and testing for compliance with the requirements for aggregate shown in the following table:

Aggregate Gradation Acceptance Criteria

Quality characteristic	Test method	Requirements		
Gradation (% passing by weight) Sieve Size:	California Test 202	Type I	Type II	Type III
3/8"		--	100	100
No. 4		100	94-100	70-90
No. 8		90-100	65-90	45-70
No. 16		60-90	40-70	28-50
No. 30		40-65	25-50	19-34
No. 200		10-20	5-15	5-15

An aggregate gradation test represents 300 tons or 1 day's production, whichever is less.

If test results for aggregate gradation do not comply with the specifications, you may remove the slurry seal or micro-surfacing represented by the test results or request it remain in place with a payment deduction. If your request is authorized, the Department deducts:

1. \$1.75 per ton of slurry seal for each noncompliant aggregate gradation
2. \$2.00 per ton of micro-surfacing for each noncompliant aggregate gradation

37-3.01B Materials

37-3.01B(1) General

Additional water must not cause separation of the asphaltic emulsion, polymer modified asphaltic emulsion or micro-surfacing emulsion from the aggregate before placement.

You may use an additive that does not adversely affect the slurry seal or micro-surfacing.

37-3.01B(2) Aggregate

Aggregate must be rock dust. Aggregate must be free from vegetable matter, deleterious substances, caked or clay lumps, and oversized particles.

Aggregate for a slurry seal and micro-surfacing must comply with the gradations shown in the following table:

Aggregate Gradation

Quality characteristic	Test method	Requirements		
Gradation (% passing by weight) Sieve size:	California Test 202	Type I	Type II	Type III
3/8"		--	100	100
No. 4		100	94-100	70-90
No. 8		90-100	65-90	45-70
No. 16		60-90	40-70	28-50
No. 30		40-65	25-50	19-34
No. 200		10-20	5-15	5-15

37-3.01C Construction

37-3.01C(1) General

Before applying slurry seals or micro-surfacings, cover manholes, valve and monument covers, grates, and other exposed facilities located within the area of application using plastic or oil resistant construction paper secured by tape or adhesive to the facility being covered. Reference the covered facilities with enough control points to relocate the facilities after application of the slurry seals or micro-surfacings.

37-3.01C(2) Proportioning

Proportion slurry seal and micro-surfacing ingredients in compliance with the authorized mix design.

37-3.01C(3) Mixing and Spreading Equipment

37-3.01C(3)(a) General

Mixing and spreading equipment for slurry seals and micro-surfacings must proportion the asphaltic emulsions, water, aggregate, and any additives by volume and mix them in continuous pug mill mixers.

Introduce emulsions into the mixer with a positive displacement pump. If you use a variable-rate pump, the adjusting unit must be sealed in its calibrated position.

Introduce water into the mixer through a meter that measures gallons.

Choose a truck mounted mixer-spreader or continuous self-loading mixer spreader.

37-3.01C(3)(b) Truck Mounted Mixer Spreaders

Truck mounted mixer spreaders must comply with:

1. Rotating and reciprocating equipment must be covered with metal guards.
2. Proportion aggregate using a belt feeder with an adjustable cutoff gate. The Engineer verifies the height of the gate opening.
3. Belt feeder must have a depth monitor device. The depth monitor device must automatically shut down power to the belt feeder when the aggregate depth is less than 70 percent of the target depth.
4. Separate monitor device must detect the revolutions of the belt feeder. This device must automatically shut down power to the belt feeder if it detects no revolutions. If the belt feeder is an integral part of the equipment's drive chain, the monitor device is not required.
5. Aggregate belt feeder must be connected directly to the drive on the emulsion pump. The aggregate feeder drive shaft must have a revolution counter reading the nearest 0.10 revolution for micro-surfacing, and nearest 1 revolution for slurry seal.
6. Emulsion storage must be equipped with a device that automatically shuts down power to the emulsion pump and aggregate belt feeder when the level of stored emulsion is lowered. To allow for normal fluctuations, there may be a delay of 3 seconds between detection of low emulsion storage levels or low aggregate depths and automatic power shut down.
7. Emulsion storage must be located immediately before the emulsion pump.
8. Emulsion storage tank must have a temperature indicator at the pump suction level. The indicator must be accurate to ± 5 degrees F.
9. No-flow and revolution warning devices must be in working condition. Low-flow indicators must be visible while walking alongside the equipment.

37-3.01C(3)(c) Continuous Self-Loading Mixer Spreaders

Continuous self-loading mixer spreaders must be automatically sequenced and self-propelled. The mixing machine must deliver each material to a double shafted mixer and discharge the mixed material on a continuous flow basis. The mixing machines must have sufficient storage capacity to maintain a continuous supply of material to the proportioning controls. The mixing machine operators must have full control of forward and reverse speeds during placement.

37-3.01C(3)(d) Spreader Boxes

The spreader boxes used to spread slurry seals and micro-surfacings must be:

1. Capable of spreading the slurry seal or micro-surfacing a minimum of 12 feet wide and preventing the loss of slurry seal or micro-surfacing.
2. Equipped with flexible rubber belting on each side. The belting must contact the pavement to prevent the loss of slurry seal or micro-surfacing from the box.
3. Equipped to uniformly apply the slurry seal or micro-surfacing on superelevated sections and shoulder slopes. Micro-surfacing spreader box must be equipped with reversible motor driven augers.
4. Equipped with a series of strike-off devices at its rear.
 - 4.1. The leading strike off device must be:
 - 4.1.1. Fabricated of a suitable material such as steel or stiff rubber
 - 4.1.2. Designed to maintain close contact with the pavement during spreading
 - 4.1.3. Capable of obtaining the specified thickness
 - 4.1.4. Capable of being adjusted to the various pavement cross sections
 - 4.2. The final strike-off device must be:
 - 4.2.1. Fabricated of flexible material that produces a uniform texture in the finished surface

4.2.2. Cleaned daily and changed if longitudinal scouring occurs in the slurry seal or micro-surfacing

5. Clean and free of slurry seal or micro-surfacing at the start of each work shift.

37-3.01C(3)(e) Shoulder Equipment

Spread the slurry seal or micro-surfacing on shoulders with a device such as an edge box that forms clean and straight joints and edges.

37-3.01C(3)(f) Equipment Calibration

Equipment calibration must comply with the *MPQP*. Notify the Engineer at least 5 business days before calibrating.

If the Department authorizes a truck or continuous mixer spreader, its calibration is valid for 6 months provided you:

1. Use the same truck or continuous mixer spreader verified with a unique identifying number
2. Use the same materials in compliance with the authorized mix design
3. Do not perform any repair or alteration to the proportioning systems

Calibrate the adjustable cut-off gate settings of each truck or continuous mixer spreader on the project to achieve the correct delivery rate of aggregate and emulsion per revolution of the aggregate feeder under the *MPQP*.

Checks must be performed for each aggregate source using an authorized vehicle scale.

Individual checks of the aggregate belt feeder's delivery rate to the pug mill mixer must not vary more than 2 percent from the average of 3 runs of at least 3 tons each.

Before using a variable-rate emulsion pump, the pump must be calibrated and sealed in the calibrated condition under the *MPQP*.

Individual checks of the emulsion pump's delivery rate to the pug mill mixer must not vary more than 2 percent from the average of 3 runs of at least 500 gal each.

37-3.01C(4) Surface Preparation

Immediately before applying slurry seals or micro-surfacings, clean the surface to receive slurry seals or micro-surfacings by removing any extraneous material affecting adhesion of the slurry seal or micro-surfacing with the existing surface. Use self-propelled power brooms or other methods such as flushing to clean the existing pavement.

37-3.01C(5) Placement

37-3.01C(5)(a) General

If truck-mounted mixer-spreaders are used, keep at least 2 operational spreaders at the job site during placement.

Spread slurry seals and micro-surfacings uniformly and do not spot, rehandle, or shift the mixture. However in areas inaccessible to spreading equipment, spread the slurry seal or micro-surfacing mixtures with hand tools or other authorized methods. If placing with hand tools, lightly dampen the area first.

You may fog the roadway surface with water ahead of the spreader box. The fog spray must be adjusted for pavement:

1. Temperature
2. Surface texture
3. Dryness

You determine the application rates for slurry seals or micro-surfacings and the Engineer authorizes the application rates. Spread within 10 percent of authorized rate.

The mixtures must be uniform and homogeneous after spreading, and there must not be separation of the emulsion and aggregate after setting.

37-3.01C(5)(b) Weather Conditions

Only place slurry seals or micro-surfacings if both the pavement and air temperatures are at least 50 degrees F and rising. The expected high temperature must be at least 65 degrees F within 24 hours after placement.

Do not place slurry seals or micro-surfacings if rain is imminent or the air temperature is expected to be below 36 degrees F within 24 hours after placement.

37-3.01C(5)(c) Joints

Transverse and longitudinal joints must be:

1. Uniform
2. Straight
3. Neat in appearance
4. Without material buildup
5. Without uncovered areas

Transverse joints must be butt-type joints.

Prevent double placement at transverse joints over previously placed slurry seals or micro-surfacings.

Place longitudinal joints:

1. On centerlines, lane lines, edge lines, or shoulder lines
2. With overlaps not more than 4 inches

You may request other longitudinal joint patterns if they do not adversely affect the slurry seals or micro-surfacings.

The maximum difference between the pavement surface and the bottom edge of a 12-foot straightedge placed perpendicular to the longitudinal joint must be 0.04 foot.

37-3.01C(5)(d) Finished Surfaces

Finished slurry seals or micro-surfacings must be smooth and free of irregularities such as scratch or tear marks. You may leave up to 4 marks that are up to 1 inch wide and 6 inches long per 75 linear feet of slurry seal or micro-surfacing placed. Do not leave any marks that are over 1 inch wide or 6 inches long.

37-3.01C(5)(e) Maintenance Sweeping

Sweep the slurry seals or micro-surfacings 24 hours after placement without damaging the slurry seals or micro-surfacings. For 4 days afterwards, sweep the slurry seals or micro-surfacings daily unless determined otherwise by the Engineer.

37-3.01C(5)(f) Repair of Early Distress

The slurry seals or micro-surfacings must not show bleeding, raveling, separation, or other distresses for 15 days after placing. If bleeding, raveling, delaminating, rutting, or wash-boarding occurs after placing the slurry seals or micro-surfacings, make repairs using an authorized method.

37-3.01D Payment

Not Used

37-3.02 SLURRY SEALS

37-3.02A General

37-3.02A(1) Summary

Section 37-3.02 includes specifications for applying slurry seals.

Applying a slurry seal consists of spreading a mixture of asphaltic emulsion or polymer modified asphaltic emulsion, aggregate, additives, and water on a surface or pavement.

37-3.02A(2) Definitions

Reserved

37-3.02A(3) Submittals

Immediately after sampling, submit two 1-quart wide mouth plastic containers of asphaltic emulsion or polymer modified asphaltic emulsion taken in the presence of the Engineer. Samples must be submitted in insulated shipping containers.

37-3.02A(4) Quality Assurance**37-3.02A(4)(a) General**

Reserved

37-3.02A(4)(b) Quality Control**37-3.02A(4)(b)(i) General**

Take samples of asphaltic emulsion and polymer modified asphaltic emulsion from the tank truck at mid load or from a sampling tap or thief. Before taking samples, draw and dispose of 1 gallon. In the presence of the Engineer take two 1-quart samples in wide mouth plastic containers with lined, sealed lids for acceptance testing.

37-3.02A(4)(b)(ii) Asphaltic Emulsion

For asphaltic emulsions, the authorized laboratory must perform quality control sampling and testing at the specified frequency and location for the following quality characteristics:

Asphaltic Emulsion

Quality characteristic	Test method	Minimum sampling and testing frequency	Sampling location
Saybolt Furol Viscosity, at 25 °C (Saybolt Furol seconds)	AASHTO T 59	Minimum 1 per day per delivery truck	Delivery truck
Sieve Test (%)			
Storage stability, 1 day (%)			
Residue by distillation (%)			
Particle charge ^a			
Tests on Residue from Distillation Test:			
Penetration, 25 °C	AASHTO T 49	Minimum 1 per day per delivery truck	Delivery truck
Ductility	AASHTO T 51		
Solubility in trichloroethylene	AASHTO T 44		

^aIf the result of the particle charge is inconclusive, the asphaltic emulsion must be tested for pH under ASTM E70. Grade QS1h asphaltic emulsion must have a minimum pH of 7.3. Grade CQS1h asphaltic emulsion must have a maximum pH of 6.7.

37-3.02A(4)(b)(iii) Polymer Modified Asphaltic Emulsion

For polymer modified asphaltic emulsions, the authorized laboratory must perform quality control sampling and testing at the specified frequency and location for the following quality characteristics:

Polymer Modified Asphaltic Emulsion

Quality characteristic	Test method	Minimum sampling and testing frequency	Sampling Location
Tests on emulsion:			
Saybolt Furol Viscosity at 25 °C (Saybolt Furol seconds)	AASHTO T 59	Minimum 1 per day per delivery truck	Delivery truck
Sieve test (%)	AASHTO T 59		
Storage stability after 1 day (%)	AASHTO T 59		
Residue by evaporation (min, %)	California Test 331		
Particle charge	AASHTO T 59		
Tests on residue by evaporation:			
Penetration at 25 °C	AASHTO T 49	Minimum 1 per day per delivery truck	Delivery truck
Ductility at 25 °C (min, mm)	AASHTO T 51		
Torsional recovery (min, %)	California Test 332		
Or Polymer content based on residual asphalt (min, %)	California Test 401		

37-3.02A(4)(c) Department Acceptance

For a slurry seal asphaltic emulsion and polymer modified asphaltic emulsion, acceptance is based on the Department's sampling and testing for compliance with the requirements for the quality characteristics specified.

Aggregate acceptance is based on the Department's sampling and testing for compliance with the requirements shown in the following table:

Aggregate Acceptance Criteria

Quality characteristic	Test method	Requirement
Los Angeles Rattler loss (max, %) At 500 revolutions	California Test 211 ^a	35
Percent of crushed particles (min, %)	California Test 205	95
Durability (min)	California Test 229	55
Sand equivalent (min)	California Test 217	
Type I		
Type II		
Type III		60

^aCalifornia Test 211 must be performed on the source aggregate before crushing.

A sand equivalent test represents 300 tons or 1 day's production, whichever is less.

If test results for sand equivalent do not comply with the specifications, you may remove the slurry seal represented by the test results or request it remain in place with a payment deduction. If your request is authorized, the Department deducts \$1.75 per ton of slurry seal for each noncompliant sand equivalent test.

37-3.02B Materials

37-3.02B(1) General

Reserved

37-3.02B(2) Asphaltic Emulsions

An asphaltic emulsion must comply with the requirements in Section 94. The asphaltic emulsion must be Grade CQS1h.

37-3.02B(3) Polymer Modified Asphaltic Emulsions

A polymer modified asphaltic emulsion must:

1. Consist of an elastomeric polymer mixed with an asphaltic material uniformly emulsified with water and an emulsifying or stabilization agent.
2. Use either neoprene polymer or butadiene and styrene copolymer. The polymer must be homogeneous and milled into the asphaltic emulsion at the colloid mill.
3. Be Grade PMCQS1h and must comply with the requirements shown in the following table:

Polymer Modified Asphaltic Emulsion Requirements

Quality characteristic	Test method	Requirement
Tests on emulsion:		
Saybolt Furol Viscosity at 25 °C (Saybolt Furol seconds)	AASHTO T 59	15–90
Sieve test (%)	AASHTO T 59	0–0.3
Storage stability after 1 day (%)	AASHTO T 59	0–1
Residue by evaporation (min, %)	California Test 331	60
Particle charge	AASHTO T 59	Positive
Tests on residue by evaporation:		
Penetration at 25 °C	AASHTO T 49	40–90
Ductility at 25 °C (min, mm)	AASHTO T 51	400
Torsional recovery (min, %)	California Test 332	18
Or		
Polymer content based on residual asphalt (min, %)	California Test 401	2.5

37-3.02B(4) Aggregate

Aggregate must comply with the quality characteristic requirements shown in the following table:

Aggregate Requirements

Quality characteristic	Test method	Requirement
Los Angeles Rattler loss (max, %) At 500 revolutions	California Test 211 ^a	35
Percent of crushed particles (min, %)	California Test 205	95
Durability (min)	California Test 229	55
Sand equivalent (min)		
Type I	California Test 217	45
Type II		55
Type III		60

^aCalifornia Test 211 must be performed on the source aggregate before crushing. The aggregate supplier must certify that the crushed aggregate being used on the project is manufactured from the source aggregate complying with the LA rattler requirements.

37-3.02B(5) Slurry Seal Mix Design

The slurry seal mix design, using project source aggregate, an asphaltic emulsion, and set-control agents if any, must comply with the requirements shown in the following table:

Slurry Seal Mix Design Requirements

Quality characteristic	Test method ^a	Requirement
Consistency (max, mm)	Technical Bulletin 106	30
Wet stripping	Technical Bulletin 114	Pass
Compatibility	Technical Bulletin 115	Pass ^b
Cohesion test, within 1 hour (min, kg-mm)	Technical Bulletin 139	200
Wet track abrasion (max, g/m ²)	Technical Bulletin 100	810

^aTest methods are by the International Slurry Surfacing Association.

^bMixing test must pass at the maximum expected air temperature at the job site during placement.

The mix design must have the percent of asphaltic residue, based on percentage by weight of the dry aggregate, within the ranges shown in the following table:

Slurry seal type	Residue range
Type I	10–16
Type II	7.5–13.5
Type III	6.5–12.0

Determine the exact percentage based on the design asphalt binder content and the asphalt residual content of the asphaltic emulsion furnished.

37-3.02C Construction

37-3.02C(1) General

Reserved

37-3.02C(2) Proportioning

After proportioning, slurry seal mixtures must be workable.

37-3.02C(3) Mixing and Spreading Equipment

Reserved

37-3.02C(4) Placement

The slurry seal spread rates must be within the ranges shown in the following table:

Slurry Seal Spread Rates	
Slurry seal type	Application range (lb of dry aggregate/sq yd)
Type I	8–12
Type II	10–18
Type III	20–25

Within 4 hours after placement, slurry seals must be set enough to allow traffic without pilot cars. Protect slurry seals from damage until it has set and will not adhere or be picked up by vehicle tires. Slurry seals must not exhibit distress from traffic such as bleeding, raveling, separation or other distresses.

37-3.02D Payment

The payment quantity for slurry seal is the weight determined by combining the weights of the aggregate and asphaltic emulsion or polymeric asphaltic emulsion. The payment quantity for slurry seal does not include the weights of the added water and set-control additives.

37-3.03 MICRO-SURFACINGS

37-3.03A General

37-3.03A(1) Summary

Section 37-3.03 includes specifications for applying micro-surfacings.

Applying a micro-surfacing consists of spreading a mixture of a micro-surfacing emulsion, water, additives, mineral filler, and aggregate on the pavement.

37-3.03A(2) Definitions

Reserved

37-3.03A(3) Submittals

Immediately after sampling, submit two 1-quart wide mouth plastic containers of micro-surfacing emulsion taken in the presence of the Engineer. Samples must be submitted in insulated shipping container.

37-3.03A(4) Quality Assurance

37-3.03A(4)(a) General

Reserved

37-3.03A(4)(b) Quality Control

37-3.03A(4)(b)(i) General

Reserved

37-3.03A(4)(b)(ii) Micro-surfacing Emulsions

Take samples from the truck tank at mid load from a sampling tap or thief. Before taking samples, draw and dispose of 1 gallon. In the presence of the Engineer, take two 1-quart wide mouth plastic containers for acceptance testing.

For a micro-surfacing emulsion, the authorized laboratory must perform quality control sampling and testing at the specified frequency and location for the quality characteristics shown in the following table:

Micro-Surfacing Emulsion

Quality characteristic	Test method	Minimum sampling and testing frequency	Sampling location
Tests on emulsion:			
Saybolt Furol Viscosity, at 25°C (Saybolt Furol seconds)	AASHTO T 59	Minimum 1 per day per delivery truck	Delivery truck
Storage stability, 1 day (max, %) ^a			
Sieve test (max, %)			
Residue by evaporation (min, %)	California Test 331	Minimum 1 per day per delivery truck	Delivery truck
Tests on residue from evaporation test:			
Penetration at 25 °C	AASHTO T 49	Minimum 1 per day per delivery truck	Delivery truck
Softening point (min, °C)	AASHTO T 53		

^aStorage stability test will be run if the storage exceeds 48 hours

37-3.03A(4)(c) Department Acceptance

For micro-surfacing emulsions, acceptance is based on the Department's sampling and testing for compliance with the requirements shown in the following table:

Micro-surfacing Emulsion Acceptance Criteria

Quality characteristic	Test method	Requirement
Tests on emulsion:		
Saybolt Furol Viscosity at 25 °C (Saybolt Furol seconds)	AASHTO T 59	15–90
Sieve test (%)	AASHTO T 59	0.30
Storage stability, 1 day (max, %)	AASHTO T 59	0–1
Settlement ^a , 5 days (max, %)	ASTM D244	5
Residue by evaporation (min, %)	California Test 331	62
Tests on residue by evaporation:		
Penetration at 25 °C	AASHTO T 49	40–90
Softening point (min, °C)	AASHTO T 53	57

^aSettlement test on emulsion is not required if used within 48 hours of shipment.

Acceptance of aggregate, except mineral filler, is based on the Department’s sampling and testing for compliance with the requirements shown in the following table:

Aggregate Acceptance Criteria

Quality characteristic	Test method	Requirement
Los Angeles Rattler loss (max, %) At 500 revolutions	California Test 211 ^a	35
Percent of crushed particles (min, %)	California Test 205	95
Durability (min)	California Test 229	65
Sand equivalent (min)	California Test 217	
Type II		65
Type III		65

^aCalifornia Test 211 must be performed on the aggregate before crushing. The aggregate supplier must certify that the crushed aggregate being used on the project is manufactured from the source aggregate complying with the LA rattler requirements.

An aggregate sand equivalent test represents 300 tons or 1 day's production, whichever is less.

If the test results for aggregate sand equivalent do not comply with the specifications, you may remove the micro-surfacing represented by the test results or request it remain in place with a payment deduction. If your request is authorized, the Department deducts \$2.00 per ton of micro-surfacing for each noncompliant aggregate sand equivalent test.

37-3.03B Materials

37-3.03B(1) General

Reserved

37-3.03B(2) Micro-surfacing Emulsions

A micro-surfacing emulsion must be a homogeneous mixture of asphalt, an elastomeric polymer and an emulsifier solution.

Add an elastomeric polymer modifier to asphalt or emulsifier solution before emulsification. An elastomeric polymer solid must be a minimum of 3 percent by weight of the micro-surfacing emulsion's residual asphalt.

A micro-surfacing emulsion must comply with the requirements shown in the following table:

Micro-surfacing Emulsion Requirements

Quality characteristic	Test method	Requirement
Tests on emulsion:		
Saybolt Furol Viscosity at 25 °C (Saybolt Furol seconds)	AASHTO T 59	15–90
Sieve test (%)	AASHTO T 59	0.30
Storage stability, 1 day (max, %)	AASHTO T 59	0–1
Settlement ^a , 5 days (max, %)	ASTM D244	5
Residue by evaporation (min, %)	California Test 331	62
Tests on residue by evaporation:		
Penetration at 25 °C	AASHTO T 49	40–90
Softening point (min, °C)	AASHTO T 53	57

^aSettlement test on emulsion is not required if used within 48 hours of shipment.

37-3.03B(3) Aggregate

Aggregate must comply with the quality characteristic requirements shown in the following table:

Aggregate Requirements

Quality characteristic	Test method	Requirement
Los Angeles Rattler loss (max, %) At 500 revolutions	California Test 211 ^a	35
Percent of crushed particles (min, %)	California Test 205	95
Durability (min)	California Test 229	65
Sand equivalent (min)	California Test 217	
Type II		65
Type III		65

^aCalifornia Test 211 must be performed on the source aggregate before crushing. The aggregate supplier must certify that the crushed aggregate being used on the project is manufactured from the source aggregate complying with the LA rattler requirements.

37-3.03B(4) Mineral Fillers

If a mineral filler is used, it must be type I or type II Portland cement. A mineral filler used during mix design must be used during production.

37-3.03B(5) Micro-Surfacing Mix Designs

The micro-surfacing mix design must have the material proportion limits shown in the following table:

Micro-surfacing Mix Design Proportion Limits

Material	Proportion limits
Micro-surfacing emulsion asphalt residual content (% of dry weight of aggregate)	5.5–10.5
Water and additives	As Required
Mineral filler (% of dry weight of aggregate)	0–3

The micro-surfacing mix design must comply with the requirements shown in the following table:

Micro-surfacing Mix Design Requirements

Quality characteristics	Test method ^a	Requirement
Wet cohesion At 30 minutes (set) (min, kg-cm) At 60 minutes (traffic) (min, kg-cm)	Technical Bulletin 139	12 20
Excess asphalt (max, g/m ²)	Technical Bulletin 109	540
Wet stripping (min, %)	Technical Bulletin 114	90
Wet track abrasion loss 6-day soak (max, g/m ²)	Technical Bulletin 100	810
Displacement Lateral (max, %) Specific gravity after 1000 cycles of 57 kg (max)	Technical Bulletin 147A	5 2.10
Classification compatibility (min, grade points)	Technical Bulletin 144	(AAA, BAA) 11
Mix time at 25 °C (min)	Technical Bulletin 113	Controllable to 120 seconds

^aTest methods are by the International Slurry Surfacing Association.

37-3.03B(6) Tack Coats

If there is a bid item for tack coat, you must coat the pavement surface with an asphaltic emulsion mixed with additional water before applying a micro-surfacing. The maximum ratio of water to asphaltic emulsion must be 2 to 1. Apply the tack coat at a rate from 0.08 to 0.15 gal/sq yd. The exact rate must be authorized.

You determine the grade of slow-setting or quick setting asphaltic emulsion to be used.

37-3.03C Construction

37-3.03C(1) General

Reserved

37-3.03C(2) Proportioning

Field conditions may require adjustments to the proportions within the authorized mix design during construction.

37-3.03C(3) Mixing and Spreading Equipment

37-3.03C(3)(a) General

Reserved

37-3.03C(3)(b) Scratch Course Boxes

Spread the scratch courses with the same type of spreader box used to spread micro-surfacings except use an adjustable steel strike-off device instead of a final strike-off device.

37-3.03C(3)(c) Wheel Path Depression Boxes

Each wheel path depression box must have adjustable strike-off device between 5 and 6 feet wide to regulate depth. The wheel path depression box must also have devices such as hydraulic augers capable of:

1. Moving the mixed material from the rear to the front of the filling chamber
2. Guiding larger aggregate into the deeper section of the wheel path depression
3. Forcing the finer material towards the outer edges of the spreader box

37-3.03C(4) Test Strips

If micro-surfacing placement will require more than 1 day, you must construct a test strip. The test strip must be:

1. From 300 to 450 feet long
2. The same as the full production micro-surfacing
3. On 1 of the application courses specified at an authorized location

4. At the same time of day or night the full production micro-surfacing is to be applied

If multiple application courses are specified, you may construct test strips over 2 days or nights.

The Engineer evaluates the test strip after traffic has used it for 12 hours. If the Engineer determines the mix design or placement procedure is unacceptable, make modifications and construct a new test strip for the Engineer's evaluation.

37-3.03C(5) Placement

37-3.03C(5)(a) General

Reserved

37-3.03C(5)(b) Repair Wheel Path Depressions

If repairing wheel path depressions is shown in plans, fill wheel path depressions and irregularities with micro-surfacing material before spreading micro-surfacing. If the depressions are less than 0.04 foot deep, fill with a scratch course. If the depressions are 0.04 foot deep or more, fill the depressions using a wheel path depression box.

Spread scratch courses by adjusting the steel strike-off of a scratch course box until it is directly in contact with the pavement surface.

Spread micro-surfacings with a wheel path depression box leaving a slight crown at the surface. Use multiple applications to fill depressions more than 0.12 foot deep. Do not apply more than 0.12 foot in a single application.

Allow traffic to compact each filled wheel path depression for a minimum of 12 hours before placing additional micro-surfacings.

37-3.03C(5)(c) Micro-surfacing Pavement Surfaces

The micro-surfacing spread rates must be within the ranges shown in the following table:

Micro-surfacing type	Application range (lb of dry aggregate/sq yd)
Type II	10–20
Type III ^a	20–32
Type III ^b	30–32

^aOver asphalt concrete pavement

^bOver concrete pavement and concrete bridge decks

Within 2 hours after placement, micro-surfacings must be set enough to allow traffic without pilot cars. Protect the micro-surfacings from damage until it has set and will not adhere or be picked up by vehicle tires. Micro-surfacings must not exhibit distress from traffic such as bleeding, raveling, separation or other distresses.

37-3.03D Payment

The payment quantity for micro-surfacing is the weight determined by combining the weights of the aggregate and micro-surfacing emulsion. The payment quantity for micro-surfacing does not include the weights of added water, mineral filler, and additives.

37-3.04 RUBBERIZED AND MODIFIED SLURRY SEALS

Reserved

37-4 FOG SEALS AND FLUSH COATS

37-4.01 GENERAL

37-4.01A General

37-4.01A(1) Summary

Section 37-4.01 includes general specifications for applying fog seals and flush coats.

37-4.01A(2) Definitions

Reserved

37-4.01A(3) Submittals

At least 15 days before use, submit:

1. Sample of asphaltic emulsion in two 1-quart plastic container with lined, sealed lid
2. Asphaltic emulsion information and test data as follows:
 - 2.1. Supplier
 - 2.2. Type/Grade of asphalt emulsion
 - 2.3. Copy of the specified test results for asphaltic emulsion

37-4.01B Materials

Not Used

37-4.01C Construction

37-4.01C(1) General

Reserved

37-4.01C(2) Weather Conditions

Only place a fog seal or flush coat if both the pavement and ambient temperatures are at least 50 degrees F and rising. Do not place a fog seal or flush coat within 24 hours of rain or within 24 hours of forecast rain or freezing temperatures.

37-4.01D Payment

Not Used

37-4.02 FOG SEALS

37-4.02A General

37-4.02A(1) Summary

Section 37-4.02 includes specifications for applying fog seals.

Applying a fog seal includes applying a diluted slow-setting or quick setting asphaltic emulsion.

37-4.02A(2) Definitions

Reserved

37-4.02A(3) Submittals

Immediately after sampling, submit two 1-quart plastic container of asphaltic emulsion taken in the presence of the Engineer. Samples must be submitted in insulated shipping container.

37-4.02A(4) Quality Assurance

37-4.02A(4)(a) General

Reserved

37-4.02A(4)(b) Quality Control

37-4.02A(4)(b)(i) General

Reserved

37-4.02A(4)(b)(ii) Asphaltic Emulsions

Circulate asphaltic emulsions in the distributor truck before sampling. Take samples from the distributor truck at mid load or from a sampling tap or thief. Before taking samples, draw and dispose of 1 gallon. In the presence of the Engineer, take asphalt emulsion sample in two 1-quart plastic container with lined, sealed lid.

For asphaltic emulsions, the authorized laboratory must perform quality control sampling and testing at the specified frequency and location for the following quality characteristics:

Asphaltic Emulsion

Quality characteristic	Test Method	Minimum sampling and testing frequency	Sampling location
Saybolt Furol Viscosity, at 25 °C (Saybolt Furl seconds)	AASHTO T 59	Minimum 1 per day per delivery truck	Distributor truck
Sieve Test (%)			
Storage stability, 1 day (%)			
Residue by distillation (%)			
Particle charge ^a			
Tests on Residue from Distillation Test:			
Penetration, 25 °C	AASHTO T 49	Minimum 1 per day per delivery truck	Distributor truck
Ductility	AASHTO T 51		
Solubility in trichloroethylene	AASHTO T 44		

^aIf the result of the particle charge is inconclusive, the asphaltic emulsion must be tested for pH under ASTM E70. Grade QS1h asphaltic emulsion must have a minimum pH of 7.3. Grade CQS1h asphaltic emulsion must have a maximum pH of 6.7.

37-4.02A(4)(b)(iii) Asphaltic Emulsion Spread Rates

For fog seals, the authorized laboratory must perform sampling and testing at the specified frequency and location for the following quality characteristics:

Fog Seal Quality Control Requirements

Quality characteristic	Test method	Minimum sampling and testing frequency	Location of sampling
Asphaltic emulsion spread rate (gal/sq yd)	California Test 339	2 per day	Pavement surface

37-4.02A(4)(c) Department Acceptance

Fog seal acceptance is based on:

1. Visual inspection for the following:
 - 1.1. Uniform surface texture throughout the work limits
 - 1.2. Flushing consisting of the occurrence of a film of asphaltic material on the surface
 - 1.4. Streaking consisting of alternating longitudinal bands of asphaltic emulsion approximately parallel with the lane line
2. The Department's sampling and testing for compliance with the requirements for the quality characteristics specified in section 94 for asphaltic emulsion
3. Department's sampling and testing for compliance with the requirements for fog seal shown in the following table:

Fog Seal Acceptance Criteria

Quality Characteristic	Test Method	Requirement
Asphaltic emulsion spread rate (gal/sq yd)	California Test 339	TV ± 10%

37-4.02B Materials

You determine the grade of slow-setting or quick setting asphaltic emulsion to be used.

37-4.02C Construction

Apply asphaltic emulsions for fog seals at a residual asphalt rate from 0.02 to 0.06 gal/sq yd.

If additional water is added to the asphaltic emulsions, the resultant mixture must not be more than 1 part asphaltic emulsion to 1 part water. You determine the dilution rate.

If the fog seals become tacky, sprinkle water as required.

If fog seals and chip seals are on the same project, the joint between the seal coats must be neat and uniform.

37-4.02D Payment

The Department does not adjust the unit price for an increase or decrease in the asphaltic emulsion quantity.

37-4.03 FLUSH COATS

37-4.03A General

37-4.03A(1) Summary

Section 37-4.03 includes specifications for applying flush coats.

Applying a flush coat includes applying a fog seal coat followed by sand.

37-4.03A(2) Definitions

Reserved

37-4.03A(3) Submittals

At least 15 days before use, submit:

1. Proposed target X values for sand gradation.
2. Gradation test results for sand

Submit quality control test results for sand gradation within 2 business days of sampling.

37-4.03A(4) Quality Assurance

37-4.03A(4)(a) General

Reserved

37-4.03A(4)(b) Quality Control

For sand, the authorized laboratory must perform sampling and testing at the specified frequency and location for the following quality characteristics:

Sand Quality Control

Quality characteristic	Test method	Minimum sampling and testing frequency	Location of sampling
Gradation (% passing by weight)	California Test 202	1 per day	See California Test 125

37-4.03A(4)(c) Department Acceptance

Flush coat acceptance is based on fog seal acceptance and the following:

1. Visual inspection for uniform application of sand.
2. Sand acceptance is based on the Department's sampling and testing for compliance with the requirements shown in the following table:

Sand Gradation Acceptance Criteria

Quality characteristic	Test method	Requirement
Gradation (% passing by weight)	California Test 202	
Sieve size:		
3/8"		100
No. 4		93–100
No. 8		61–99
No. 16		X ± 13
No. 30		X ± 12
No. 50		X ± 9
No.100		1–15
No. 200	0–10	

NOTE: "X" is the gradation that you propose to furnish for the specific sieve size.

37-4.03B Material

37-4.03B(1) General

Reserved

37-4.03B(2) Sand

Sand must be free from deleterious coatings, clay balls, roots, bark, sticks, rags, and other extraneous material.

Sand for a flush coat must comply with the gradations shown in the following table:

Sand Gradation

Quality characteristic	Test method	Requirement
Gradation (% passing by weight)	California Test 202	
Sieve size:		
3/8"		100
No. 4		93–100
No. 8		61–99
No. 16		X ± 13
No. 30		X ± 12
No. 50		X ± 9
No.100		1–15
No. 200	0–10	

NOTE: "X" is the gradation that you propose to furnish for the specific sieve size.

Fine aggregate sizes must be distributed such that the difference between the total percentage passing the No. 16 and No. 30 sieves is from 10 to 40, and the difference between the percentage passing the No. 30 and No. 50 sieves is from 10 to 40.

37-4.03C Construction

37-4.03C(1) General

During flush coat activities, close adjacent lanes to traffic. Do not track asphaltic emulsion on existing pavement surfaces.

Apply sand immediately after applying asphaltic emulsions.

Spread sand aggregate with a mechanical device that spreads sand at a uniform rate over the full width of a traffic lane in a single application. Spread sand at a rate from 2 to 6 lb/sq yd. You determine the application rates for sand and the Engineer authorizes the application rate.

37-4.03C(2) Sweeping

Sweep loose sand material remaining on the surface 24 hours after application.

37-4.03D Payment

The Department does not adjust the unit price for an increase or decrease in the sand cover (seal) quantity.

37-5 PARKING AREA SEALS

37-5.01 GENERAL

37-5.01A Summary

Section 37-5 includes specifications for applying parking area seals. Sealing a parking area consists of spreading a mixture of asphaltic emulsion, aggregate, polymer, and water.

37-5.01B Definitions

Reserved

37-5.01C Submittals

At least 15 days before starting placement, submit a 20 lb sample of the aggregate to be used.

At least 10 days before starting placement, submit:

1. Name of the authorized laboratory to perform testing and mix design.
2. Laboratory report of test results and a proposed mix design. The report and mix design must include the specific materials to be used and show a comparison of test results and specifications. The mix design report must include the quantity of water allowed to be added at the job site. The authorized laboratory performing the tests must sign the original laboratory report and mix design.
3. Manufacturer's data for oil seal primer and polymer.

If the mix design consists of the same materials covered by a previous laboratory report, you may submit the previous laboratory report that must include material testing data performed within the previous 12 months for authorization.

If you request substitute materials, submit a new laboratory report and mix design at least 10 days before starting placement.

Submit a certificate of compliance for the parking area seal material.

Immediately after sampling, submit two 1-quart plastic containers of parking area seal taken in the presence of the Engineer. Samples must be submitted in insulated shipping containers.

37-5.01D Quality Assurance

37-5.01D(1) General

Reserved

37-5.01D(2) Quality Control

37-5.01D(2)(a) General

Reserved

37-5.01D(2)(b) Asphaltic Emulsions

For an asphaltic emulsion, the authorized laboratory must perform quality control sampling and testing at the specified frequency and location for the following quality characteristics:

Asphaltic Emulsion

Quality characteristic	Test Method	Minimum sampling and testing frequency	Sampling location
Saybolt Furol Viscosity, at 25 °C (Saybolt Furol seconds)	AASHTO T 59	Minimum 1 per day per delivery truck	Distributor truck
Sieve Test (%)			
Storage stability, 1 day (%)			
Residue by distillation (%)			
Particle charge ^a			
Tests on Residue from Distillation Test			
Penetration, 25 °C	AASHTO T 49	Minimum 1 per day per delivery truck	Distributor truck
Ductility	AASHTO T 51		
Solubility in trichloroethylene	AASHTO T 44		

^aIf the result of the particle char is inconclusive, the asphaltic emulsion must be tested for pH under ASTM E70. Grade QS1h asphaltic emulsion must have a minimum pH of 7.3. Grade CQS1h asphaltic emulsion must have a maximum pH of 6.7.

37-5.01D(2)(c) Sand

For sand, the authorized laboratory must perform sampling and testing at the specified frequency and location for the following quality characteristics:

Sand Quality Control

Quality characteristic	Test method	Minimum sampling and testing frequency	Location of sampling
Gradation (% passing by weight)	California Test 202	One per project	See California Test 125

37-5.01D(2)(d) Parking Area Seals

For a parking area seal, the authorized laboratory must perform quality control sampling and testing at the specified frequency for the following quality characteristics:

Parking Area Seal Requirements

Quality characteristic	Test method	Frequency
Mass per liter (kg)	ASTM D244	One per project
Cone penetration (mm)	California Test 413	
Nonvolatile (%)	ASTM D2042 ^a	
Nonvolatile soluble in trichloroethylene (%)		
Wet track abrasion (g/m ²)	ASTM D3910	
Dried film color	--	
Viscosity (KU) ^b	ASTM D562	

^aWeigh 10 g of homogenous material into a previously tarred, small can. Place in a constant temperature oven at 165 ± 5 °C for 90 ± 3 minutes. Cool, reweigh, and calculate nonvolatile components as a percent of the original weight.

^bKrebs units

37-5.01D(3) Department Acceptance

Parking area seal acceptance is based on:

1. Visual inspection for:
 - 1.1. Uniform surface texture throughout the work limits
 - 1.2. Marks in the surface:
 - 1.2.1. Up to 4 marks in the completed parking area seal that are up to 1 inch wide and up to 6 inches long per 1,000 square feet of parking area seal placed.
 - 1.2.2. No marks in the completed parking area seal surface that are over 1 inch wide or 6 inches long.

- 1.2. Raveling consisting of the separation of the aggregate from the asphaltic emulsion
- 1.3. Bleeding consisting of the occurrence of a film of asphaltic material on the surface of the parking area seal
- 1.4. Delaminating of the parking area seal from the existing pavement
- 1.5. Rutting or wash-boarding
2. The Department's sampling and testing of aggregate for compliance with 100 percent passing no. 16 sieve under California Test 202
3. The Department's sampling and testing for compliance with the requirements shown in the following table:

Parking Area Seal Acceptance Criteria

Quality characteristic	Test method	Requirement
Mass per liter (min, kg)	ASTM D244	1.1
Cone penetration (mm)	California Test 413	340–700
Nonvolatile (min, %)	ASTM D2042 ^a	50
Nonvolatile soluble in trichloroethylene (%)		10–35
Wet track abrasion (max, g/m ²)	ASTM D3910	380
Dried film color	--	Black
Viscosity (min, KU) ^b	ASTM D562	75

^aWeigh 10 g of homogenous material into a previously tared, small ointment can. Place in a constant temperature oven at 165 ± 5 °C for 90 ± 3 minutes. Cool, reweigh, and calculate nonvolatile components as a percent of the original weight.

^bKrebs units

37-5.02 MATERIALS

37-5.02A General

Aggregate must be clean, hard, durable, uncoated, and free from organic and deleterious substances. One hundred percent of the aggregate must pass the no. 16 sieve.

Asphaltic emulsion must be either Grade SS1h or CSS1h, except the values for penetration at 25 degrees C for tests on residue from distillation must be from 20 to 60.

Polymer must be either neoprene, ethylene vinyl acetate, or a blend of butadiene and styrene.

Oil seal primer must be a quick-drying emulsion with admixtures. Oil seal primer must be manufactured to isolate the parking area seal from pavement with residual oils, petroleum grease, and spilled gasoline.

Crack sealant must comply with section 37-6.

Water must be potable and not separate from the emulsion before the material is placed.

37-5.02B Mix Design

The proposed mix design for a parking area seal must comply with the requirements shown in the following table:

Parking Area Seal Mix Design Requirements

Quality characteristic	Test method	Requirement
Mass per liter (min, kg)	ASTM D244	1.1
Cone penetration (mm)	California Test 413	340–700
Nonvolatile (min, %)	ASTM D2042 ^a	50
Nonvolatile soluble in trichloroethylene (%)		10–35
Wet track abrasion (max, g/m ²)	ASTM D3910	380
Dried film color	--	Black
Viscosity (min, KU) ^b	ASTM D562	75

^aWeigh 10 g of homogenous material into a previously tarred, small ointment can. Place in a constant temperature oven at 165 ± 5 °C for 90 ± 3 minutes. Cool, reweigh, and calculate nonvolatile components as a percent of the original weight.

^bKrebs units

A parking area seal must contain a minimum of 2 percent polymer by volume of undiluted asphaltic emulsion.

37-5.02C Proportioning

Parking area seal ingredients must be mixed at a central plant. The plant must include mechanical or electronic controls that consistently proportion the ingredients. Mix an asphaltic emulsion with the other ingredients mechanically.

Store the parking area seal in a tank equipped with mixing or agitation devices. Keep stored materials thoroughly mixed. Protect stored materials from freezing conditions.

37-5.03 CONSTRUCTION

37-5.03A General

Request that the Engineer shut off the irrigation control system at least 5 days before placing the seal. Do not water plants adjacent to the seal at least 24 hours before and after the seal coat placement.

37-5.03B Surface Preparations

If cracks in the existing pavement are from 1/4 to 1 inch wide, treat the cracks under section 37-6. Do not place the parking area seals until the Engineer determines that the crack treatments are cured.

If cracks in the existing pavement are greater than 1 inch wide, the Engineer orders the repair. This work is change order work.

After any crack treatment and before placing parking area seals, clean the pavement surface, including removal of oil and grease spots. Do not use solvents.

If cleaning the pavement with detergents, thoroughly rinse with water. Allow all water to dry before placing parking area seals.

You must seal oil and grease spots that remain after cleaning. Use an oil seal primer and comply with the manufacturer's instructions.

If the existing pavement has oil and grease spots that do not come clean and sealing is insufficient, the Engineer orders the repair of the pavement. This work is change order work.

Before placing the parking area seals, dampen the pavement surface using a distributor truck. Place the seal on the damp pavement but do not place it with standing water on the pavement.

37-5.03C Placement

If adding water at the job site based on the manufacturer's instructions for consistency and spreadability, do not exceed 15 percent by volume of undiluted asphaltic emulsion.

Place the parking area seals in 1 or more application. The seals must be uniform and smooth, free of ridges or uncoated areas.

If placing in multiple applications, allow the last application to thoroughly dry before the subsequent application.

Do not allow traffic on the parking area seals for at least 24 hours after placement.

Do not stripe over the parking area seals until it is dry.

37-5.04 PAYMENT

The payment quantity for parking area seal is the weight determined by combining the weights of the aggregate and asphaltic emulsion. The payment quantity for parking area seal does not include the added water and set-control additive.

37-6 CRACK TREATMENTS

37-6.01 GENERAL

37-6.01A Summary

Section 37-6 includes specifications for treating cracks in asphalt concrete pavement.

37-6.01B Definitions

Reserved

37-6.01C Submittals

If your selected crack treatment material is on the Authorized Material List for flexible pavement crack treatment material, submit a certificate of compliance including:

1. Manufacturer's name
2. Production location
3. Brand or trade name
4. Designation
5. Batch or lot number
6. Crack treatment material type
7. Contractor or subcontractor name
8. Contract number
9. Lot size
10. Shipment date
11. Manufacturer's signature

If your selected crack treatment material is not on the Authorized Material List for flexible pavement crack treatment material, submit a sample and test results from each batch or lot 20 days before use. Testing must be performed by an authorized laboratory and test results must show compliance with the specifications. Test reports must include the information specified for the certificate of compliance submittal. Each hot-applied crack treatment material sample must be a minimum of 3 lb and submitted in a silicone release container. Each cold-applied crack treatment material sample must be a minimum of 2 quarts and submitted in a plastic container.

At least 10 days before the start of work, submit sand gradation test results under California Test 202.

Submit the following with each delivery of crack treatment material to the job site:

1. Manufacturer's heating and application instructions
2. Manufacturer's SDS
3. Name of the manufacturer's recommended detackifying agent

37-6.01D Quality Assurance

37-6.01D(1) General

Hot-applied crack treatment material must be sampled at least once per project in the Engineer's presence. Collect two 3-pounds-minimum samples of crack treatment material from the dispensing wand into silicone release boxes.

Cold-applied crack treatment material must be sampled at least once per project in the Engineer's presence. Collect 2 samples of crack treatment material from the dispensing wand into 1-quart containers.

37-6.01D(2) Quality Control

Reserved

37-6.01D(3) Department Acceptance

Crack treatment acceptance is based on:

1. Visual inspection for uniform filling of cracks throughout the work limits including:
 - 1.2. Crack treatment is not more than a 1/4 inch below the specified level
 - 1.3. Sealant failures
 - 1.4. Crack re-opening
 - 1.5. Crack overbanding is less than 3 inches wide
2. The Department's sampling and testing for compliance with the requirements shown in the following table:

Crack Treatment Acceptance Criteria

Quality characteristic ^a	Test method ^b	Requirement				
		Type 1	Type 2	Type 3	Type 4	Type 5
Softening point (min, °C)	ASTM D36	102	96	90	84	84
Cone penetration at 77 °F (max)	ASTM D5329	35	40	50	70	90
Resilience at 77 °F, unaged (%)	ASTM D5329	20–60	25–65	30–70	35–75	40–80
Flexibility(°C) ^c	ASTM D3111	0	0	0	-11	-28
Tensile adhesion (min, %)	ASTM D5329	300	400	400	500	500
Specific gravity (max)	ASTM D70	1.25	1.25	1.25	1.25	1.25
Asphalt compatibility	ASTM D5329	Pass	Pass	Pass	Pass	Pass
Sieve test (% passing)	See note d	100	100	100	100	100

^aCold-applied crack treatment material residue collected under ASTM D6943, Method B and sampled under ASTM D140 must comply with the grade specified.

^bExcept for viscosity, cure each specimen at a temperature of 23 ± 2 °C and a relative humidity of 50 ± 10 percent for 24 ± 2 hours before testing.

^cFor the flexibility test, the specimen size must be 6.4 ± 0.2 mm thick by 25 ± 0.2 mm wide by 150 ± 0.5 mm long. The test mandrel diameter must be 6.4 ± 0.2 mm. The bend arc must be 180 degrees. The bend rate must be 2 ± 1 seconds. At least 4 of 5 test specimens must pass at the specified test temperature without fracture, crazing, or cracking.

^dFor hot-applied crack treatment, dilute with toluene and sieve through a no. 8 sieve. For cold-applied crack treatment, sieve the material as-received through a no. 8 sieve. If the manufacturer provides a statement that added components passed the no. 16 sieve before blending, this requirement is void.

37-6.02 MATERIALS

37-6.02A General

Reserved

37-6.02B Crack Treatment Material

A crack treatment material must comply with the requirements shown in the following table:

Crack Treatment Material

Quality characteristic ^a	Test method ^b	Requirement				
		Type 1	Type 2	Type 3	Type 4	Type 5
Softening point (min, °C)	ASTM D36	102	96	90	84	84
Cone penetration at 77 °F (max)	ASTM D5329	35	40	50	70	90
Resilience at 77 °F, unaged (%)	ASTM D5329	20–60	25–65	30–70	35–75	40–80
Flexibility(°C) ^c	ASTM D3111	0	0	0	-11	-28
Tensile adhesion (min, %)	ASTM D5329	300	400	400	500	500
Specific gravity (max)	ASTM D70	1.25	1.25	1.25	1.25	1.25
Asphalt compatibility	ASTM D5329	Pass	Pass	Pass	Pass	Pass
Sieve test (% passing)	See note d	100	100	100	100	100

^aCold-applied crack treatment material residue collected under ASTM D6943, Method B and sampled under ASTM D140 must comply with the grade specifications.

^bExcept for viscosity, cure each specimen at a temperature of 23 ± 2 °C and a relative humidity of 50 ± 10 percent for 24 ± 2 hours before testing.

^cFor the flexibility test, the specimen size must be 6.4 ± 0.2 mm thick by 25 ± 0.2 mm wide by 150 ± 0.5 mm long. The test mandrel diameter must be 6.4 ± 0.2 mm. The bend arc must be 180 degrees. The bend rate must be 2 ± 1 seconds. At least 4 of 5 test specimens must pass at the specified test temperature without fracture, crazing, or cracking.

^dFor hot-applied crack treatment, dilute with toluene and sieve through a no. 8 sieve. For cold-applied crack treatment, sieve the material as-received through a no. 8 sieve. If the manufacturer provides a statement that added components passed the no. 16 sieve before blending, this requirement is void.

A crack treatment material must be delivered to the job site with the information listed below. If crack treatment material is delivered to the job site in containers, each container must be marked with the following information.

1. Manufacturer's name
2. Production location
3. Brand or trade name
4. Designation
5. Crack treatment trade name
6. Batch or lot number
7. Maximum heating temperature
8. Expiration date for cold application only

Hot-applied crack treatment must be delivered to the job site premixed in cardboard containers with meltable inclusion liners or in a fully meltable package.

Cold-applied crack treatment must have a minimum shelf life of 3 months from the date of manufacture.

37-6.02C Sand

Sand applied to tacky crack treatment material must be clean, free of clay, and comply with the gradation shown in the following table:

Sand Gradation

Quality characteristic	Test method	Requirement
Gradation (% passing by weight)	California Test 202	
Sieve size:		
No. 4		100
No. 50		0–30
No. 200		0–5

37-6.03 CONSTRUCTION

Treat cracks from 1/4 to 1 inch in width for the entire length of the crack. Fill or repair cracks wider than 1 inch as ordered. Filling cracks wider than 1 inch is change order work.

If treating cracks on a traffic lane adjacent to a shoulder, treat the cracks on the shoulder.

For hot-applied crack treatment material, rout cracks or saw cut to form a reservoir.

Cracks must be clean and dry before treating. Before treating, blast cracks with oil-free compressed air at a pressure of at least 90 psi.

If the pavement temperature is below 40 degrees F or if there is evidence of moisture in the crack, use a hot air lance immediately before applying crack treatment. The hot air lance must not apply flame directly on the pavement.

Heat and apply hot-applied crack treatment material under with the manufacturer's instructions.

Apply cold-applied crack treatment material with a distributor kettle, a piston, or a diaphragm barrel pump that can deliver from 50 to 75 psi. The application line must have a pressure gauge and a filter. The pressure in the application line must not exceed 20 psi. The pressure gauge must have a regulator. Use a high-pressure hose with a 1/2-inch NPT swivel connection and a dispensing wand.

Apply crack treatment with a nozzle inserted into the crack. Fill the crack flush. If after 2 days the crack treatment is more than 1/4 inch below the specified level, the sealant fails, or the crack re-opens, re-treat the crack.

Immediately remove crack treatment material that is spilled or deposited on the pavement surface.

Before opening to traffic, apply sand or the manufacturer's recommended detackifying agent to tacky crack treatment material on the traveled way.

Sweep up excess sand before opening to traffic.

37-6.04 PAYMENT

The payment quantity for crack treatment is the length measured in lane miles along the edge of each paved lane parallel to the pavement's centerline. The payment for a lane includes crack treatment of the adjacent shoulder.

37-7-37-10 RESERVED

^^

39 ASPHALT CONCRETE

07-15-16

Replace SP-2 at each occurrence in section 39 with:

MS-2

01-15-16

Replace the 3rd paragraph of section 39-2.01A(1) with:

WMA technologies must be on the Authorized Material List for WMA authorized technologies.

07-15-16

Add between the 3rd and 4th paragraphs of section 39-2.01A(1):

For HMA that uses asphalt binder containing crumb rubber modifier, submit a Crumb Rubber Usage Report form monthly and at the end of the project.

04-15-16

Add to the table in the 4th paragraph of section 39-2.01A(1):

01-15-16

Asphalt Institute MS-2	7th edition (2015)
------------------------	--------------------

Add to item 8 in the 4th paragraph of section 39-2.01A(3)(b)(i):

07-15-16

, except lime supplier and source

Replace the headings and paragraphs of section 39-2.01A(3)(i) with:

01-15-16

39-2.01A(3)(i) Reserved

Replace the 2nd sentence in the 3rd paragraph of section 39-2.01A(4)(b) with:

01-15-16

Submit 3 parts and keep 1 part.

Add between *single* and *test* in the 7th paragraph of section 39-2.01A(4)(i)(i):

07-15-16

aggregate or HMA

Replace the 1st paragraph of section 39-2.01B(2)(b) with:

07-15-16

If the proposed JMF indicates that the aggregate is being treated with dry lime or lime slurry with marination, or the HMA with liquid antistrip, then testing the untreated aggregate under AASHTO T 283 and AASHTO T 324 is not required.

If HMA treatment is required or being used by the Contractor, determine the plasticity index of the aggregate blend under California Test 204.

Add between *aggregate* and *with dry lime* in the 3rd and 4th paragraphs of section 39-2.01B(2)(b):

07-15-16

blend

Replace the 9th through 11th paragraphs of section 39-2.01B(8)(a) with:

07-15-16

HMA must be produced at the temperatures shown in the following table:

HMA Production Temperatures

HMA compaction	Temperature (°F)
HMA	
Density based Method	≤ 325 305–325
HMA with WMA technology	
Density based Method	240–325 260–325

Delete the 1st paragraph of section 39-2.01B(11).

Add after the 2nd paragraph of section 39-2.01B(11):

For miscellaneous areas and dikes:

1. Choose the aggregate gradation from:
 - 1.1. 3/8-inch Type A HMA aggregate gradation
 - 1.2. 1/2-inch Type A HMA aggregate gradation
 - 1.3. 1/2-inch dike mix aggregate gradation
2. Choose asphalt binder Grade PG 64-10, PG 64-16 or PG 70-10.
3. Minimum asphalt binder content must be:
 - 3.1. 6.40 percent for 3/8-inch Type A HMA aggregate gradation
 - 3.2. 5.70 percent for 1/2-inch Type A HMA aggregate gradation
 - 3.3. 6.40 percent for 1/2-inch dike mix aggregate gradation

If you request and the Engineer authorizes, you may reduce the minimum asphalt binder content.

Aggregate gradation for 1/2-inch dike mix must be within the TV limits for the specified sieve size shown in the following table:

**Aggregate Gradation for 1/2-inch Dike Mix
(Percentage Passing)**

Sieve size	Target value limit	Allowable tolerance
3/4"	100	--
1/2"	90–95	TV ± 5
No. 4	70–75	TV ± 5
No. 8	23–25	TV ± 5
No. 50	15–35	TV ± 5
No. 200	7.0–13.0	TV ± 2.0

Replace item 4 in the 2nd paragraph of section 39-2.01C(1) with:

4. For method compaction:
 - 4.1. The temperature of the HMA and the HMA produced with WMA water injection technology in the windrow does not fall below 260 degrees F
 - 4.2. The temperature of the HMA produced using WMA additive technology in the windrow does not fall below 250 degrees F

Delete item 3 in the 8th paragraph of section 39-2.01C(1).

Replace 39-2.01A(3)(m)(iv) in the 6th paragraph of section 39-2.01C(3)(e) with:

36-3.01C(3)

Replace 2.06 in the 4th paragraph of section 39-2.01C(3)(f) with:

2.05

Add to the end of section 39-2.01C(15)(b):

The compacted lift thickness must not exceed 0.25 foot.

07-15-16

Add between *rectangles* and *with* in the 4th paragraph of section 39-2.01C(16):

, half the lane width,

04-15-16

Add between *to* and *the* in item 1 of the 4th paragraph of section 39-2.01C(16):

and along

04-15-16

Delete *coat* in the 5th paragraph of section 39-2.01C(16).

07-15-16

Replace 37 in the 5th paragraph of section 39-2.01C(16) with:

37-4.02

07-15-16

Replace section 39-2.02A(3)(b) with:

The JMF must be based on the superpave HMA mix design as described in *MS-2 Asphalt Mix Design Methods* by the Asphalt Institute.

01-15-16

Add between the 1st and 2nd paragraphs of section 39-2.02C:

If the ambient air temperature is below 60 degrees F, cover the loads in trucks with tarpaulins. If the time for HMA discharge to truck at the HMA plant until transfer to paver's hopper is 90 minutes or greater and if the ambient air temperature is below 70 degrees F, cover the loads in trucks with tarpaulins, unless the time from discharging to the truck until transfer to the paver's hopper or the pavement surface is less than 30 minutes. The tarpaulins must completely cover the exposed load until you transfer the mixture to the paver's hopper or the pavement surface.

07-15-16

Replace the table in the 2nd paragraph of section 39-2.02C with:

Minimum Ambient Air and Surface Temperatures

07-15-16

Lift thickness (feet)	Ambient air (°F)		Surface (°F)	
	Unmodified asphalt binder	Modified asphalt binder	Unmodified asphalt binder	Modified asphalt binder
Type A HMA and Type A HMA produced with WMA water injection technology				
<0.15	55	50	60	55
≥0.15	45	45	50	50
Type A HMA produced with WMA additive technology				
<0.15	45	45	50	45
≥0.15	40	40	40	40

Delete the 3rd paragraph of section 39-2.02C.

Add between *HMA* and *placed* in the 1st sentence of the 4th paragraph of section 39-2.02C:

07-15-16

and Type A HMA produced with WMA water injection technology

Add between the 4th and the 5th paragraphs of section 39-2.02C:

07-15-16

For Type A HMA produced with WMA additive technology placed under method compaction, if the asphalt binder is:

1. Unmodified, complete:
 - 1.1 1st coverage of breakdown compaction before the surface temperature drops below 240 degrees F
 - 1.2 Breakdown and intermediate compaction before the surface temperature drops below 190 degrees F
 - 1.3 Finish compaction before the surface temperature drops below 140 degrees F
 - 1.4 You may continue static rolling below 140 degrees F to remove roller marks.
2. Modified, complete:
 - 2.1 1st coverage of breakdown compaction before the surface temperature drops below 230 degrees F
 - 2.2 Breakdown and intermediate compaction before the surface temperature drops below 170 degrees F
 - 2.3 Finish compaction before the surface temperature drops below 130 degrees F
 - 2.4 You may continue static rolling below 130 degrees F to remove roller marks.

Replace the 2nd paragraph of section 39-2.03A(3)(b) with:

01-15-16

The JMF must be based on the superpave HMA mix design as described in *MS-2 Asphalt Mix Design Methods* by the Asphalt Institute.

Replace the requirement in the row for *Voids in mineral aggregate on plant produced HMA* in the 2nd table in section 39-2.03A(4)(e)(i) with:

01-15-16

18.0-23.0

Add before the 1st paragraph of section 39-2.03A(4)(e)(ii)(C):

04-15-16

CRM used must be on the Authorized Materials List for Crumb Rubber Modifier.

CRM must be a ground or granulated combination of scrap tire crumb rubber and high natural scrap tire crumb rubber, CRM must be 75.0 ± 2.0 percent scrap tire crumb rubber and 25.0 ± 2.0 percent high natural scrap tire crumb rubber by total weight of CRM. Scrap tire crumb rubber and high natural scrap tire crumb rubber must be derived from waste tires described in Pub Res Code § 42703.

Replace the row for *Hamburg wheel track* in the table in section 39-2.03B(2) with:

01-15-16

Hamburg wheel track (min, number of passes at the inflection point)	AASHTO T 324 (Modified) ^d	
Binder grade:		
PG 58		10,000
PG 64		12,500
PG 70		15,000

Replace *RHMA-G* in the 3rd and 5th paragraphs of section 39-2.03C with:

07-15-16

RHMA-G and RHMA-G produced with WMA water injection technology

Add between the 5th and 6th paragraphs of section 39-2.03C:

07-15-16

For RHMA-G produced with WMA additive technology placed under method compaction:

1. Complete the 1st coverage of breakdown compaction before the surface temperature drops below 260 degrees F
2. Complete breakdown and intermediate compaction before the surface temperature drops below 230 degrees F
3. Complete finish compaction before the surface temperature drops below 180 degrees F
4. You may continue static rolling below 140 degrees F to remove roller marks

Replace the 6th and 7th paragraphs of section 39-2.04C with:

07-15-16

For HMA-O and HMA-O produced with WMA water injection technology:

1. With unmodified asphalt binder:
 - 1.1. Spread and compact only if the atmospheric temperature is at least 55 degrees F and the surface temperature is at least 60 degrees F.
 - 1.2. Complete the 1st coverage using 2 rollers before the surface temperature drops below 240 degrees F.
 - 1.3. Complete all compaction before the surface temperature drops below 200 degrees F.
2. With modified asphalt binder, except asphalt rubber binder:
 - 2.1. Spread and compact only if the atmospheric temperature is at least 50 degrees F and the surface temperature is at least 50 degrees F.
 - 2.2. Complete the 1st coverage using 2 rollers before the surface temperature drops below 240 degrees F.
 - 2.3. Complete all compaction before the surface temperature drops below 180 degrees F.

For HMA-O produced with WMA additive technology:

1. With unmodified asphalt binder:
 - 1.1. Spread and compact only if the atmospheric temperature is at least 45 degrees F and the surface temperature is at least 50 degrees F.
 - 1.2. Complete the 1st coverage using 2 rollers before the surface temperature drops below 230 degrees F.
 - 1.3. Complete all compaction before the surface temperature drops below 190 degrees F.
2. With modified asphalt binder, except asphalt rubber binder:
 - 2.1. Spread and compact only if the atmospheric temperature is at least 40 degrees F and the surface temperature is at least 40 degrees F.
 - 2.2. Complete the 1st coverage using 2 rollers before the surface temperature drops below 230 degrees F.

2.3. Complete all compaction before the surface temperature drops below 170 degrees F.

Replace *RHMA-O* and *RHMA-O-HB* in the 8th paragraph of section 39-2.04C with:

07-15-16

RHMA-O and RHMA-O produced with WMA water injection technology, and RHMA-O-HB and RHMA-O-HB produced with WMA water injection technology

Add between the 8th and 9th paragraphs of section 39-2.04C:

07-15-16

For RHMA-O produced with WMA additive technology and RHMA-O-HB produced with WMA additives technology:

1. Spread and compact if the ambient air temperature is at least 45 degrees F and the surface temperature is at least 50 degrees F
2. Complete the 1st coverage using 2 rollers before the surface temperature drops below 270 degrees F
3. Complete all compaction before the surface temperature drops below 240 degrees F

Add to the 2nd paragraph of section 39-2.05A(3)(b):

01-15-16

The material transfer vehicle must receive HMA directly from the truck.

Replace *Table 6.1* at each occurrence in the table in section 39-2.05B(2) with:

01-15-16

Table 8.1

Replace *SP-2 Asphalt Mixture* in the 1st footnote in the table in the 2nd paragraph of section 39-2.05B(2)(b) with:

01-15-16

MS-2 Asphalt Mix Design Methods

Replace *Manual Series No. 2 (MS-2)* in the 1st footnote in the table in the 2nd paragraph of section 39-2.05B(2)(b) with:

01-15-16

MS-2 Asphalt Mix Design Methods

Replace 39-3.05 in the 1st paragraph of section 39-3.04A with:

01-15-16

39-3.04

Add to the end of section 39-3.04A:

07-15-16

Schedule cold planing activities such that the pavement is cold planed, the HMA is placed, and the area is opened to traffic during the same work shift.

Delete the 2nd sentence of the 1st paragraph in section 39-3.04C(4).

07-15-16

Delete *business* in item 6 in the list in the 8th paragraph of section 49-1.01D(4).

07-15-16

Add to the list in 9th paragraph of section 49-1.01D(4):

07-15-16

3. Cut pile to the specified cut-off elevation after bearing acceptance criteria is provided by the Department

Delete the 3rd paragraph of section 49-1.03.

04-15-16

Delete the 2nd paragraph of section 49-1.04.

04-15-16

Delete the 4th paragraph of section 49-2.01C(5).

01-15-16

Replace item 3 in the list in the 2nd paragraph of section 49-3.01A with:

07-15-16

3. CISS concrete piles

Add between *undisturbed material* and *in a dry* in the 1st paragraph of section 49-3.01C:

07-15-16

, casing, or steel shell

Replace the 2nd and 3rd paragraphs of section 49-3.01C with:

07-15-16

Place and secure reinforcement. Securely block the reinforcement to provide the minimum clearance shown between the reinforcing steel cage and the sides of the drilled hole, casing, or steel shell.

Steel shells, casings, and drilled holes must be clean and free of debris before reinforcement and concrete are placed.

Replace *dewatered* in the 4th paragraphs of section 49-3.01C with:

07-15-16

drilled

Add to section 49-3.02A(1):

07-15-16

Permanent steel casing and driven steel shell must comply with section 49-2.02.

Replace the paragraph of section 49-3.02A(2) with:

07-15-16

dry hole: A drilled hole that requires no work to keep it free of water.

dewatered hole: A drilled hole that:

1. Accumulates no more than 12 inches of water at the bottom during a 1 hour period without any pumping from the hole.

2. Has no more than 3 inches of water at the bottom immediately before placing concrete.
3. Does not require temporary casing to control the groundwater.

Replace item 8 in the list in the 1st paragraph of section 49-3.02A(3)(b) with:

07-15-16

8. Drilling plan and sequence
9. Concrete sequence and placement plan
10. If inspection pipes are required, methods for ensuring the inspection pipes remain straight, undamaged, and properly aligned during concrete placement

Replace 1 business day in the paragraph of section 49-3.02A(3)(d) with:

07-15-16

2 business days

Add to section 49-3.02A(3)(d):

07-15-16

The log must:

1. Show the pile location, tip elevation, cutoff elevation, dates of excavation and concrete placement, total quantity of concrete placed, length and tip elevation of any casing, and details of any hole stabilization method and materials used.
2. Include an 8-1/2 by 11 inch graph of concrete placed versus depth of hole filled as follows:
 - 2.1. Plot the graph continuously throughout concrete placement. Plot the depth of drilled hole filled vertically with the pile tip at the bottom and the quantity of concrete placed horizontally.
 - 2.2. Take readings at each 5 feet of pile depth, and indicate the time of the reading on the graph.

Add after the sentence in the paragraph of section 49-3.02A(3)(e):

07-15-16

Allow 10 days for the review.

Replace the 3rd sentence in the paragraph of section 49-3.02A(3)(f) with:

07-15-16

Allow 10 days for the review and analysis of this report.

Add after *rejected pile* in the 1st sentence in the 1st paragraph of section 49-3.02A(3)(g):

07-15-16

to be mitigated

Delete the 2nd paragraph of section 49-3.02A(3)(g).

07-15-16

Replace item 3 in the list in the 3rd paragraph of section 49-3.02A(3)(g) with:

07-15-16

3. Step by step description of the mitigation work to be performed, including drawings if necessary. If the *ADSC Standard Mitigation Plan* is an acceptable mitigation method, include the most recent version. For the most recent version of the *ADSC Standard Mitigation Plan*, go to:
<http://www.dot.ca.gov/hq/esc/geotech/ft/adscmitplan.htm>

Replace the 2nd sentence in the paragraph of section 49-3.02A(3)(i) with:

07-15-16

Allow 10 days for the review.

Add to section 49-3.02A(3):

07-15-16

49-3.02A(3)(j) Certifications

If synthetic slurry is used, submit as an informational submittal the names and certifications of your employees who are trained and certified by the synthetic slurry manufacturer.

Add after *excavated hole* in the 1st sentence in the 3rd paragraph of section 49-3.02A(4)(c):

07-15-16

lined with plastic

Replace the 1st paragraph of section 49-3.02A(4)(d)(i) with:

07-15-16

Section 49-3.02A(4)(d) applies to CIDH concrete piles except for piles (1) less than 24 inches in diameter or (2) constructed in dry or dewatered holes.

Replace *gamma-gamma logging* in the 2nd paragraph of section 49-3.02A(4)(d)(i) with:

07-15-16

GGL

Replace the 1st sentence in the 3rd paragraph of section 49-3.02A(4)(d)(i) with:

07-15-16

After notification by the Engineer of pile acceptance, fill the inspection pipes and cored holes with grout.

Replace *gamma-gamma logging* in section 49-3.02A(4)(d)(ii) with:

07-15-16

GGL

Replace the 3rd and 4th paragraphs of section 49-3.02A(4)(d)(iii) with:

07-15-16

The Department may perform CSL to determine the extent of the anomalies identified by GGL and to further evaluate a rejected pile for the presence of anomalies not identified by GGL. The pile acceptance test report will indicate if the Department intends to perform CSL and when the testing will be performed. Allow the Department 20 additional days for a total of 50 days to perform CSL and to provide supplemental results.

If authorized, you may perform testing on the rejected pile.

Delete the 8th paragraph of section 49-3.02A(4)(d)(iii).

07-15-16

Add to the end of section 49-3.02A(4)(d)(iii):

07-15-16

If the Engineer determines it is not feasible to repair the rejected pile, submit a mitigation plan for replacement or supplementation of the rejected pile.

Add to section 49-3.02A(4):

07-15-16

49-3.02A(4)(e) Certifications

If synthetic slurry is used, your employees who will be providing technical assistance in the slurry activities must be trained and certified by the synthetic slurry manufacturer to show their competency to perform inspection of slurry operations.

Replace section 49-3.02B(4) with:

07-15-16

49-3.02B(4) Reserved

Replace *near* in the 3rd, 4th, and 5th paragraphs of section 49-3.02B(6)(b) with:

07-15-16

within 2 feet of

Replace *twice per shift* in item 2 in the 3rd paragraph of section 49-3.02B(6)(b) with:

07-15-16

every 4 hours

Delete the 7th and 8th paragraphs of section 49-3.02B(6)(b).

07-15-16

Delete the 3rd paragraph of section 49-3.02B(6)(c).

07-15-16

Replace *near* in item 2 in the 4th paragraph of section 49-3.02B(6)(c) with:

07-15-16

within 2 feet of

Replace item 5 in the 4th paragraph of section 49-3.02B(6)(c) with:

07-15-16

5. After final cleaning and immediately before placing concrete.

Replace section 49-3.02B(9) with:

07-15-16

49-3.02B(9) Inspection Pipes

Inspection pipes must be schedule 40 PVC pipe complying with ASTM D1785 with a nominal pipe size of 2 inches.

Watertight PVC couplers complying with ASTM D2466 are allowed to facilitate pipe lengths in excess of those commercially available.

Add to the beginning of section 49-3.02C(1):

07-15-16

Unless otherwise authorized, drilling the hole and placing reinforcement and concrete in the hole must be performed in a continuous operation.

Replace the 5th paragraph of section 49-3.02C(2) with:

07-15-16

If slurry is used during excavation, maintain the slurry level at a height required to maintain a stable hole, but not less than 10 feet above the piezometric head.

Replace the 1st sentence in the 9th paragraph of section 49-3.02C(2) with:

07-15-16

Remove water that has infiltrated the dewatered hole before placing concrete, as required for dewatered hole.

Replace the 1st sentence in the 10th paragraph of section 49-3.02C(2) with:

07-15-16

If authorized, to control caving or water seepage, you may enlarge portions of the hole, backfill the hole with slurry cement backfill, concrete, or other material, and redrill the hole to the diameter shown.

Replace the 4th paragraph of section 49-3.02C(3) with:

07-15-16

Remove the temporary casing during concrete placement. Maintain the concrete in the casing at a level required to maintain a stable hole, but not less than 5 feet above the bottom of the casing, to prevent displacement of the concrete by material from outside the casing.

Replace the 5th paragraph of section 49-3.02C(4) with:

07-15-16

For a single CIDH concrete pile supporting a column:

1. If the pile and the column share the same reinforcing cage diameter, this cage must be accurately placed as shown
2. If the pile reinforcing cage is larger in diameter than the column cage:
 - 2.1. Maintain a clear horizontal distance of at least 3.5 inches between the two cages, if the concrete is placed under dry conditions
 - 2.2. Maintain a clear horizontal distance of at least 5 inches between the two cages if the concrete is placed under slurry
 - 2.3. The offset between the centerlines of the two cages must not exceed 6 inches

Replace the paragraphs in section 49-3.02C(5) with:

07-15-16

For acceptance testing, install and test vertical inspection pipes as follows:

1. Log the location of the inspection pipe couplers with respect to the plane of pile cutoff.
2. Cap each inspection pipe at the bottom. Extend the pipe from 3 feet above the pile cutoff to the bottom of the reinforcing cage. Provide a temporary top cap or similar means to keep the pipes clean before testing. If pile cutoff is below the ground surface or working platform, extend inspection pipes to 3 feet above the ground surface or working platform.
3. If any changes are made to the pile tip, extend the inspection pipes to the bottom of the reinforcing cage.
4. Install inspection pipes in a straight alignment and parallel to the main reinforcement. Securely fasten inspection pipes in place and provide protective measures to prevent misalignment or damage to the inspection pipes during installation of the reinforcement and placement of concrete in the hole. Construct CIDH concrete piles such that the relative distance of inspection pipes to vertical steel reinforcement remains constant.
5. After concrete placement is complete, fill inspection pipes with water to prevent debonding of the pipe.
6. Provide safe access to the tops of the inspection pipes.

7. After placing concrete and before requesting acceptance testing, test each inspection pipe in the Engineer's presence by passing a rigid cylinder through the length of pipe. The rigid cylinder must be 1-1/4-inch diameter by 4.5-foot long, weigh 12 pounds or less, and be able to freely pass down through the entire length of the pipe under its own weight and without the application of force.
8. When performing acceptance testing, inspection pipes must provide a 2-inch-diameter clear opening and be completely clean, unobstructed, and either dry or filled with water as authorized.
9. After acceptance testing is complete, completely fill the inspection pipes with water.

If the rigid cylinder fails to pass through the inspection pipe:

1. Completely fill the inspection pipes in the pile with water immediately.
2. Core a nominal 2-inch-diameter hole through the concrete for the entire length of the pile for each inspection pipe that does not pass the rigid cylinder. Coring must not damage the pile reinforcement.
3. Locate cored holes as close as possible to the inspection pipes they are replacing and no more than 5 inches clear from the reinforcement.

Core holes using a double wall core barrel system with a split tube type inner barrel. Coring with a solid type inner barrel is not allowed.

Coring methods and equipment must provide intact cores for the entire length of the pile.

Photograph and store concrete cores as specified for rock cores in section 49-1.01D(5).

The coring operation must be logged by an engineering geologist or civil engineer licensed in the State and experienced in core logging. Coring logs must comply with the Department's *Soil and Rock Logging, Classification, and Presentation Manual* for rock cores. Coring logs must include core recovery, rock quality designation of the concrete, locations of breaks, and complete descriptions of inclusions and voids encountered during coring.

The Department evaluates the portion of the pile represented by the cored hole based on the submitted coring logs and concrete cores. If the Department determines a pile is anomalous based on the coring logs and concrete cores, the pile is rejected.

Replace item 2 in the list in the 2nd paragraph of section 49-3.02C(7) with:

07-15-16

2. Extend at least 5 feet below the construction joint. If placing casing into rock or a dry hole, the casing must extend at least 2 feet below the construction joint.

Add to the beginning of section 49-3.02C(9):

07-15-16

49-3.02C(9)(a) General

Replace the 2nd sentence of the 3rd paragraph of section 49-3.02C(9) with:

04-15-16

Do not vibrate the concrete.

Add after *concrete pump* in the 8th paragraph of section 49-3.02C(9):

07-15-16

and slurry pump

Replace item 3 in the list in the 11th paragraph of section 49-3.02C(9) with:

07-15-16

3. Maintain the slurry level at a height required to maintain a stable hole, but not less than 10 feet above the piezometric head.

Replace the 13th paragraph of section 49-3.02C(9) with:

07-15-16

Maintain a log of concrete placement for each drilled hole.

Replace 14th and 15th paragraphs of section 49-3.02C(9) with:

07-15-16

If a temporary casing is used, maintain concrete placed under slurry at a level required to maintain a stable hole, but not less than 5 feet above the bottom of the casing. The withdrawal of the casing must not cause contamination of the concrete with slurry.

The equivalent hydrostatic pressure inside the casing must be greater than the hydrostatic pressure on the outside of the casing to prevent intrusion of water, slurry, or soil into the column of freshly placed concrete.

Remove scum, laitance, and slurry-contaminated concrete from the top of the pile.

Add to section 49-3.02C(9):

07-15-16

49-3.02C(9)(b) Mineral Slurry

Remove any caked slurry on the sides or bottom of hole before placing reinforcement.

If concrete is not placed immediately after placing reinforcement, the reinforcement must be removed and cleaned of slurry, the sides of the drilled hole must be cleaned of caked slurry, and the reinforcement again placed in the hole for concrete placement.

49-3.02C(9)(c) Synthetic Slurry

A manufacturer's representative must:

1. Provide technical assistance for the use of their material
2. Be at the job site before introduction of the synthetic slurry into the drilled hole
3. Remain at the job site until released by the Engineer

After the manufacturer's representative has been released by the Engineer, your employee certified by the manufacturer must be present during the construction of the pile under slurry.

Replace the heading of section 49-3.03 with:

07-15-16

CAST-IN-STEEL SHELL CONCRETE PILING

Replace the 1st paragraph of section 49-3.03A(1) with:

07-15-16

Section 49-3.03 includes specifications for constructing CISS concrete piles consisting of driven open-ended or closed-ended steel shells filled with reinforcement and concrete.

Add to the end of section 49-3.03A(1):

07-15-16

CISS concrete piles include Class 90 Alternative V and Class 140 Alternative V piles.

Add to section 49-3.03A(3):

01-15-16

Submit a Pile and Driving Data Form under section 49-2.01A(3)(a) if specified in the special provisions.

Each load cell must be calibrated and have an indicator that can be used to determine the force in the prestressing steel.

The range of each load cell must be such that the lower 10 percent of the manufacturer's rated capacity is not used in determining the jacking force.

Each jack must be calibrated equipped with its gauges.

Mechanically calibrate the gauges with a dead weight tester or other authorized means before calibration of the jacking equipment.

50-1.01D(2)(b)(ii) Post-tensioning

Equip each hydraulic jack used to tension prestressing steel with 2 pressure gauges or 1 pressure gauge and a load cell. Only 1 pressure gauge must be connected to the jack during stressing.

Each jack used to tension prestressing steel permanently anchored at 25 percent or more of its specified minimum ultimate tensile strength must be calibrated by METS within 1 year of use and after each repair. You must:

1. Schedule the calibration of the jacking equipment with METS.
2. Verify that the jack and supporting systems are complete, with proper components, and are in good operating condition.
3. Provide labor, equipment, and material to (1) install and support the jacking and calibration equipment and (2) remove the equipment after the calibration is complete.
4. Plot the calibration results.

Each jack used to tension prestressing steel permanently anchored at less than 25 percent of its specified minimum ultimate tensile strength must be calibrated by an authorized laboratory within 180 days of use and after each repair.

50-1.01D(2)(b)(iii) Pretensioning

Each jack used to pretension prestressing steel must be calibrated, equipped with its gauges, by a laboratory on the Authorized Laboratory List within 1 year of use and after each repair.

Calibrate pretensioning jacks:

1. Under ASTM E4 using an authorized laboratory. Certification that the calibration is performed to ASTM accuracy is not required.
2. In the presence of the Engineer. Notify the Engineer at least 2 business days before calibrating the jack.
3. Using 3 test cycles. Average the forces from each test cycle at each increment.
4. To cover the load range used in the work.

Gauges for pretensioning jacks may:

1. Be electronic pressure indicators that display either:
 - 1.1. Pressure in 100 psi increments or less
 - 1.2. Load to 1 percent of the maximum sensor/indicator capacity or 2 percent of the maximum load applied, whichever is smaller
2. Have a dial less than 6 inches in diameter

Gauges displaying pressure must have been calibrated within 1 year of the jack calibration.

Each hydraulic jack used for pretensioning must be equipped with either 2 gauges or 1 gauge and a load cell or you must have a calibrated standby jack with its gauge present on site during stressing.

^^

51 CONCRETE STRUCTURES

07-15-16

Add to the list in the 2nd paragraph of section 51-1.01A:

8. Pile extensions

04-15-16

9. Drainage inlets

07-15-16

Add to the list in the 6th paragraph of section 51-1.01A:

7. Drainage inlets

07-15-16

Add to section 51-1.02I:

Metal frames, covers, grates, and other miscellaneous iron and steel used with drainage inlets must comply with section 75-2.

07-15-16

Add to section 51-1.03B:

You may use PC drainage inlets as an alternative to CIP drainage inlets.

07-15-16

Add between the 10th and 11th paragraphs of section 51-1.03C(2)(a):

For drainage inlets, extend the outside forms at least 12 inches below the top of the inlet. You may place concrete against excavated earth below this depth except:

07-15-16

1. You must use full-depth outside forms or other protection when work activities or unstable earth may cause hazardous conditions or contamination of the concrete.
2. You must increase the wall thickness 2 inches if placing concrete against the excavated surface. The interior dimensions must be as shown.

Add to section 51-1.03C(2)(b):

For drainage inlets, remove exterior forms to at least 12 inches below the final ground surface. Exterior forms below this depth may remain if their total thickness is not more than 1 inch.

07-15-16

Add to the list in the 2nd paragraph of section 51-1.03F(2):

4. Interior and top surfaces of drainage inlets

07-15-16

Add to section 51-1.04:

The payment quantity for structural concrete, drainage inlet is the volume determined from the dimensions shown for CIP drainage inlets.

07-15-16

Add to section 51-4.01C(1):

For PC drainage inlets, submit field repair procedures and a patching material test sample before repairs are made. Allow 10 days for the Engineer's review.

07-15-16

Add to section 51-4.01C(2)(a):

07-15-16

For drainage inlets with oval or circular cross sections, submit shop drawings with calculations. Shop drawings and calculations must be sealed and signed by an engineer who is registered as a civil engineer in the State. Allow 15 days for the Engineer's review.

Add to section 51-4.01D(3):

07-15-16

The Engineer may reject PC drainage inlets exhibiting any of the following:

1. Cracks more than 1/32 inch wide
2. Nonrepairable honeycombed or spalled areas of more than 6 square inches
3. Noncompliance with reinforcement tolerances or cross sectional area shown
4. Wall, inlet floor, or lid less than minimum thickness
5. Internal dimensions less than dimensions shown by 1 percent or 1/2 inch, whichever is greater
6. Defects affecting performance or structural integrity

Add to section 51-4.02C:

07-15-16

Materials for PC drainage inlets must comply with the following:

1. Preformed flexible joint sealant must be butyl-rubber complying with ASTM C990
2. Resilient connectors must comply with ASTM C923
3. Sand bedding must comply with section 19-3.02F(2)
4. Bonding agents must comply with ASTM C1059/C1059, Type II

Add to section 51-4.02D:

07-15-16

51-4.02D(8) Drainage Inlets

PC units for drainage inlets must be rectangular, round, or oval in cross section, or any combination. Transitions from a rectangular grate opening to a round or oval basin must be made in not less than 8 inches. Provide means for field adjustment to meet final grade, paving, or surfacing.

If oval or circular shape cross-sections are furnished, they must comply with *AASHTO LRFD Bridge Design Specifications, Sixth Edition with California Amendments*.

Wall and slab thicknesses may be less than the dimensions shown by at most 5 percent or 3/16 inch, whichever is greater.

Reinforcement placement must not vary more than 1/2 inch from the positions shown.

Add to section 51-4.03:

07-15-16

51-4.03H Drainage Inlets

Repair PC drainage inlet sections to correct damage from handling or manufacturing imperfections before installation.

Center pipes in openings to provide a uniform gap. Seal gaps between the pipe and the inlet opening with nonshrink grout under the grout manufacturer's instructions. For systems designated as watertight, seal these gaps with resilient connectors.

Match fit keyed joints to ensure uniform alignment of walls and lids. Keys are not required at the inlet floor level if the floor is precast integrally with the inlet wall. Seal keyed joint locations with preformed butyl rubber joint sealant. You may seal the upper lid and wall joint with nonshrink grout.

Replace item 2 in the list in the 3rd paragraph of section 53-1.02 with:

01-15-16

- 2. You may substitute a maximum of 30 percent coarse aggregate for the fine aggregate. Coarse aggregate must comply with section 90-1, except section 90-1.02C(4)(d) does not apply. The gradation for the coarse aggregate must comply with the gradation specified in section 90-1.02C(4)(b) for the 1/2 inch x No. 4 or the 3/8 inch x No. 8 primary aggregate nominal size.

Replace *shotcrete* in the 2nd sentence of the 4th paragraph of section 53-1.02 with:

01-15-16

concrete

^^

56 OVERHEAD SIGN STRUCTURES, STANDARDS, AND POLES

07-15-16

Replace section 56-1.01 with:

07-15-16

56-1.01 GENERAL

56-1.01A Summary

Section 56-1 includes general specifications for constructing overhead sign structures, standards, and poles.

56-1.01B Definitions

Reserved

56-1.01C Submittals

Reserved

56-1.01D Quality Assurance

56-1.01D(1) General

Reserved

56-1.01D(2) Quality Control

56-1.01D(2)(a) General

Reserved

56-1.01D(2)(b) Nondestructive Testing

56-1.01D(2)(b)(i) General

Perform NDT of steel members under AWS D1.1 and the requirements shown in the following table:

Nondestructive Testing for Steel Standards and Poles

Weld location	Weld type	Minimum required NDT
Circumferential splices around the perimeter of tubular sections, poles, and arms	CJP groove weld with backing ring	100% UT or RT
Longitudinal seam	CJP or PJP groove weld	Random 25% MT
Longitudinal seam within 6 inches of a circumferential splice	CJP groove weld	100% UT or RT
Welds attaching base plates, flange plates, pole plates, or mast arm plates to poles or arm tubes	CJP groove weld with backing ring and reinforcing fillet	$t \geq 5/16$ inch: 100% UT and 100% MT $t < 5/16$ inch: 100% MT after root weld pass and final weld pass
	External (top) fillet weld for socket-type connections	100% MT
Hand holes and other appurtenances	Fillet and PJP welds	MT full length on random 25% of all standards and poles

NOTE: t = pole or arm thickness

Nondestructive Testing for Overhead Sign Structures

Weld location	Weld type	Minimum required NDT
Base plate to post	CJP groove weld with backing ring and reinforcing fillet	100% UT and 100% MT
Base plate to gusset plate	CJP groove weld	100% UT
Circumferential splices of pipe or tubular sections	CJP groove weld with backing ring	100% UT or RT
Split post filler plate welds	CJP groove weld with backing bar	100% UT or RT
Longitudinal seam weld for pipe posts	CJP groove weld	t < 1/4 inch: 100% MT t ≥ 1/4 inch: 100% UT or RT
	PJP groove weld	Random 25% RT
Chord angle splice weld	CJP groove weld with backing bar	100% UT or RT
Truss vertical, diagonal, and wind angles to chord angles	Fillet weld	Random 25% MT
Upper junction plate to chord (cantilever type truss)	Fillet weld	Random 25% MT
Bolted field splice plates (tubular frame type)	CJP groove weld	100% UT and 100% MT
Cross beam connection plates (lightweight extinguishable message sign)	Fillet weld	Random 25% MT
Arm connection angles (lightweight extinguishable message sign)	Fillet weld	100% MT
Mast arm to arm plate (lightweight extinguishable message sign)	CJP groove weld with backing ring	t ≥ 5/16 inch: 100% UT and 100% MT t < 5/16 inch: 100% MT after root weld pass and final weld pass
Post angle to post (lightweight extinguishable message sign)	Fillet weld	100% MT
Hand holes and other appurtenances	Fillet and PJP welds	MT full length on random 25% of all sign structures

NOTE: t = pole or arm thickness

56-1.01D(2)(b)(ii) Ultrasonic Testing

For UT of welded joints with any members less than 5/16 inch thick or tubular sections less than 13 inches in diameter, the acceptance and repair criteria must comply with Clause 6.13.3.1 of AWS D1.1.

For UT of other welded joints, the acceptance and repair criteria must comply with Table 6.3 of AWS D1.1 for cyclically loaded nontubular connections.

After galvanization, perform additional inspection for toe cracks along the full length of all CJP groove welds at tube-to-transverse plate connections using UT.

When performing UT, use an authorized procedure under AWS D1.1, Annex S.

56-1.01D(2)(b)(iii) Radiographic Testing

The acceptance criteria for radiographic or real time image testing must comply with AWS D1.1 for tensile stress welds.

56-1.01D(2)(b)(iv) Longitudinal Seam Welds

The Engineer selects the random locations for NDT.

Grind the cover pass smooth at the locations to be tested.

If repairs are required in a portion of a tested weld, perform NDT on the repaired portion and on 25 percent of the untested portions of the weld. If more repairs are required, perform NDT on the entire weld.

56-1.01D(3) Department Acceptance

Reserved

Replace section 56-2.01D(2)(b) with:

Reserved

07-15-16

Replace the 2nd sentence of the 1st paragraph of section 56-2.02F with:

Manufactured pipe posts must comply with one of the following:

07-15-16

Add to the list in the 1st paragraph of section 56-2.02F:

4. ASTM A1085, Grade A

07-15-16

Replace the 2nd paragraph of section 56-2.02F with:

You may fabricate pipe posts from structural steel complying with ASTM A36/A36M, ASTM A709/A709M, Grade 36, or ASTM A572/A572M, Grades 42 or 50.

07-15-16

Delete the last sentence in the 1st paragraph of section 56-2.02K(2).

07-15-16

Delete the 3rd paragraph of section 56-2.02K(2).

07-15-16

Replace the 2nd paragraph of section 56-2.02K(4) with:

Safety cable at walkways must not be kinked, knotted, deformed, frayed, or spliced.

07-15-16

Replace the 1st sentence of the paragraph in section 56-2.02K(5) with:

The edges of handholes and other large post and arm openings must be ground smooth.

07-15-16

Replace the heading of section 56-3 with:

56-3 STANDARDS, POLES, PEDESTALS, AND POSTS

07-15-16

Replace the paragraph in section 56-3.01A with:

Section 56-3 includes general specifications for fabricating and installing standards, poles, pedestals, and posts.

07-15-16

Replace section 56-3.01B(2)(b) with:

07-15-16

Standards with handholes must comply with the following:

1. Include a UL-listed lug and 3/16-inch or larger brass or bronze bolt for attaching the bonding jumper for non-slip-base standards.
2. Attach a UL-listed lug to the bottom slip base plate with a 3/16-inch or larger brass or bronze bolt for attaching the bonding jumper for slip-base standards.

Replace the 1st sentence of the 3rd paragraph of section 56-3.01C(2)(a) with:

07-15-16

After each standard, pole, pedestal, and post is properly positioned, place mortar under the base plate.

Replace the 2nd sentence of the 4th paragraph of section 56-3.01C(2)(a) with:

07-15-16

The top of the foundation at curbs or sidewalks must be finished to curb or sidewalk grade.

Replace the 10th paragraph of section 56-3.01C(2)(a) with:

07-15-16

Except when located on a structure, construct foundations monolithically.

Replace the 13th paragraph of section 56-3.01C(2)(a) with:

07-15-16

Do not erect standards, poles, pedestals, or posts until the concrete foundation has cured for at least 7 days.

Replace the 14th paragraph in section 56-3.01C(2)(a) with:

07-15-16

The Engineer selects either the plumbing or raking technique for standards, poles, pedestals, and posts. Plumb or rake by adjusting the leveling nuts before tightening nuts. Do not use shims or similar devices. After final adjustments of both top nuts and leveling nuts on anchorage assemblies have been made and each standard, pole, pedestal, and post on the structure is properly positioned, tighten nuts as follows:

1. Tighten leveling nuts and top nuts, following a crisscross pattern, until bearing surfaces of all nuts, washers, and base plates are in firm contact.
2. Use an indelible marker to mark the top nuts and base plate with lines showing relative alignment of the nut to the base plate.
3. Tighten top nuts following a crisscross pattern:
 - 3.1. Additional 1/6 turn for anchor bolts greater than 1-1/2 inches in diameter.
 - 3.2. Additional 1/3 turn for other anchor bolts.
 - 3.3. Tightening tolerance for all top nuts is $\pm 1/8$ turn.

Replace the 1st sentence of the 4th paragraph of section 56-3.01C(2)(b) with:

07-15-16

If shown, use sleeve nuts on Type 1 standards.

Add to section 56-3.01C(2)(b):

07-15-16

Spiral reinforcement must be continuous above the bottom of the anchor bolts. The top termination must be either:

1. 1'-6" lap beyond the end of pitch with a 90-degree hook extending to the opposite side of the cage, or
2. 1'-6" lap beyond the end of pitch with 2 evenly spaced authorized mechanical couplers

Replace the 1st sentence of the paragraph in section 56-3.02A(4)(b) with:

07-15-16

For cast slip bases for standards and poles with shaft lengths of 15 feet or more, perform RT on 1 casting from each lot of a maximum of 50 castings under ASTM E94.

Replace the 2nd paragraph of section 56-3.02B(1) with:

07-15-16

Material for push button posts, pedestrian barricades, and guard posts must comply with ASTM A53/A53M or ASTM A500/A500M.

Add to section 56-3.02B(1):

07-15-16

Steel pipe standards and mast arms must be hot dip galvanized after manufacturing. Remove spikes from galvanized surfaces.

Replace the 2nd paragraph of section 56-3.02B(2) with:

07-15-16

HS anchor bolts, nuts, and washers must comply with section 55-1.02D(1) and the following:

1. Bolt threads must be rolled
2. Hardness of HS anchor bolts must not exceed 34 HRC when tested under ASTM F606
3. Galvanization must be by mechanical deposition
4. Nuts must be heavy-hex type
5. Each lot of nuts must be proof load tested

Replace the 2nd sentence of the 9th paragraph of section 56-3.02B(2) with:

07-15-16

During manufacturing, properly locate the position of the luminaire arm on the arm plate to avoid interference with the cap screw heads.

Add to section 56-3.02B(3)(a):

07-15-16

Steel having a nominal thickness greater than 2 inches that is used for tube-to-transverse plate connections must have a minimum CVN impact value of 20 ft-lb at 20 degrees F when tested under ASTM E23.

Add to section 56-3.02B(3)(c):

07-15-16

The length of telescopic slip-fit splices must be at least 1.5 times the inside diameter of the exposed end of the female section.

For welds connecting reinforced handholes or box-type pole plate connections to a tubular member, the start and stop points must be at points located on a longitudinal axis of symmetry of the tube coinciding with the axis of symmetry of the hand hole or pole plate.

Delete the 4th paragraph of section 59-2.01C(1).

^^

60 EXISTING STRUCTURES

07-15-16

Delete the 2nd sentence in the 11th paragraph of section 60-3.04B(3)(c).

^^

64 PLASTIC PIPE

07-15-16

Replace *Reserved* in section 64-3 with:

64-3.01 GENERAL

64-3.01A Summary

Section 64-3 includes specifications for constructing slotted plastic pipe.

Slotted plastic pipe includes structure excavation, concrete backfill, connecting new pipe to new or existing facilities, concrete collars, reinforcement, and other connecting devices.

64-3.01B Definitions

Reserved

64-3.01C Submittals

If an *or* equal slotted plastic pipe is being considered, it must be submitted 30 days before installation for approval.

If RSC is used for concrete backfill for slotted plastic pipe, submit the concrete mix design and test data from an authorized laboratory 10 days before excavating the pipe trench. The laboratory must specify the cure time required for the concrete mix to attain 2,000 psi compressive strength when tested under California Test 521.

Heel-resistant grates if specified must be submitted 30 days before installation for approval. Anchorage details must be included in the submittal.

64-3.01D Quality Assurance

Reserved

64-3.02 MATERIALS

64-3.02A General

Not Used

64-3.02B Slotted Plastic Pipes

Slotted plastic pipe must be one of the following or equal:

Slotted Plastic Pipe

12" diameter	18" diameter
Zurn Z888-12	Zurn Z888-18
ACO Qmax 350	ACO Qmax 365
ADS Duraslot-12	ADS Duraslot-18

64-3.02C Concrete Backfill

Concrete for concrete backfill for slotted plastic pipe must comply with the specifications for minor concrete. You may use RSC instead of minor concrete for concrete backfill.

If RSC is used for concrete backfill, the RSC must:

1. Contain at least 590 pounds of cementitious material per cubic yard
2. Comply with section 90-3.02A, except section 90-1 does not apply
3. Comply with section 90-2

64-3.02D Heel-Resistant Grates

Heel-resistant grate must:

1. Be designed to carry traffic loadings
2. Comply with ADA requirements
3. Be constructed of steel or cast iron
4. Be provided by the same manufacturer of the slotted plastic pipe
5. Comply with the manufacturer's instructions

64-3.02E Bar Reinforcement

Bar reinforcement must comply with ASTM A615/A615M, Grade 60 or ASTM A706/A706M, Grade 60.

64-3.02F Miscellaneous Metal

Ductile iron, nuts, bolts, and washers must comply with section 75.

64-3.02G Grout

Grout must be non-shrink grout complying with ASTM C1107/C1107M.

64-3.02H Curing Compound

Non-pigmented curing compound must comply with ASTM C309, Type 1, Class B.

64-3.02I End Caps

End cap must:

1. Be provided by the same manufacturer of the slotted plastic pipe
2. Prevent concrete backfill from entering the pipe

64-3.03 CONSTRUCTION

64-3.03A General

Cover the grate slots with heavy-duty tape or other authorized covering during paving and concrete backfilling activities to prevent material from entering the slots.

64-3.03B Preparation

Pave adjacent traffic lanes before installing slotted plastic pipes.

Excavation must comply with section 19-3.

64-3.03C Installation

Lay and join slotted plastic pipes under the pipe manufacturer's instructions.

Lay pipes to line and grade with sections closely jointed and adequately secured to prevent separation during placement of the concrete backfill. If the pipes do not have a positive interlocking mechanism like a slot and tongue connection, secure the sections together with nuts, bolts, and washers before backfilling.

The top of slotted plastic pipes must not extend above the completed surface. Position the pipes so that the concrete backfill is flush with the surrounding grade and above the top of the grate from 1/8 to 1/4 inch.

Place channels with the male and female ends facing each other.

Place lateral support bar reinforcement on both sides of the grate slots. The support bar reinforcement must run the full length of the slots.

Anchor heel-resistant grates to the concrete backfill under the manufacturer's instructions.

64-3.03D Concrete Backfill

Wherever minor concrete is used for concrete backfill for slotted plastic pipe, do not allow traffic on top of the backfill within 7 days of placement.

Wherever RSC is used for concrete backfill for slotted plastic pipe, do not allow traffic on top of the backfill before the required cure time of 2,000 psi is achieved.

Place concrete backfill where shown.

Consolidate the concrete backfill with high-frequency internal vibrators.

Texture the concrete backfill surface with a broom or burlap drag to produce a durable skid-resistant surface.

Apply a non-pigmented curing compound to the exposed concrete backfill surface whenever the atmospheric temperature is 90 degrees F or greater after placement.

64-3.03E Transition Fittings

Use transition fittings to connect slotted plastic pipes to drainage inlets. The transition fittings must be supplied by the same pipe manufacturer.

Where welds are required in transition fittings, welds must comply with the pipe manufacturer's instructions. The completed welds must not have visible pinholes. Fill the gaps around the pipes in the inlet structure wall with non-shrink grout where the pipes connect to an existing drainage structure. Install the grout under the pipe manufacturer's instructions.

Cut the pipes as shown after the grout used to seal the transition fitting has cured for at least 24 hours.

64-3.04 PAYMENT

Slotted plastic pipe is measured along the centerline of the pipe and parallel with the slope line. If the pipe is cut to fit a structure or slope, the payment quantity is the length of pipe necessary to be placed before cutting, measured in 2-foot increments.

^^

DIVISION VII DRAINAGE FACILITIES

71 EXISTING DRAINAGE FACILITIES

01-15-16

Replace items 5 and 6 in the list in the 1st paragraph of section 71-3.01D with:

- 5. Performing postrehabilitation inspection

01-15-16

Add after the 4th paragraph of section 71-3.01D:

01-15-16

Record the quantity of grout that is installed and submit this quantity. The Department does not pay for grout that leaks through to the inside of the culvert. The Department does not pay for grout material that is wasted, disposed of, or remaining on hand after the completion of the work.

Replace the 2nd heading in section 71-5.03 with:

01-15-16

71-5.03B Frames, Covers, Grates, and Manholes

DIVISION VIII MISCELLANEOUS CONSTRUCTION
72 SLOPE PROTECTION

07-15-16

Replace the 1st and 2nd paragraphs of section 72-2.02B with:

07-15-16

For method A and B placement and the class of RSP described, comply with the rock gradation shown in the following table:

Nominal RSP class by median particle diameter ^b		Nominal median particle weight $W_{50}^{c,d}$	Rock Gradation d_{15}^c (inches)		d_{50}^c (inches)		d_{100}^c (inches)	Placement
Class ^a	Diameter (inches)		Min	Max	Min	Max	Max	Method
I	6	20 lb	3.7	5.2	5.7	6.9	12.0	B
II	9	60 lb	5.5	7.8	8.5	10.5	18.0	B
III	12	150 lb	7.3	10.5	11.5	14.0	24.0	B
IV	15	300 lb	9.2	13.0	14.5	17.5	30.0	B
V	18	1/4 ton	11.0	15.5	17.0	20.5	36.0	B
VI	21	3/8 ton	13.0	18.5	20.0	24.0	42.0	A or B
VII	24	1/2 ton	14.5	21.0	23.0	27.5	48.0	A or B
VIII	30	1 ton	18.5	26.0	28.5	34.5	48.0	A or B
IX	36	2 ton	22.0	31.5	34.0	41.5	52.8	A
X	42	3 ton	25.5	36.5	40.0	48.5	60.5	A
XI	46	4 ton	28.0	39.4	43.7	53.1	66.6	A

^aFor RSP Classes I–VIII, use Class 8 RSP fabric. For RSP Classes IX–XI, use Class 10 RSP fabric.

^bIntermediate or B dimension (i.e., width) where A dimension is length and C dimension is thickness.

^cd%, where % denotes the percentage of the total weight of the graded material.

^dValues shown are based on the minimum and maximum particle diameters shown and an average specific gravity of 2.65. Weight will vary based on specific gravity of rock available for the project.

Replace the table in section 72-2.02C with:

07-15-16

Fabric Class

Class	Largest rock gradation class used in slope protection
8	Classes I–VIII
10	Classes IX–XI

Replace the table in the 1st paragraph of section 72-3.02C with:

07-15-16

Concreted-Rock Gradation

Nominal RSP class by median particle diameter ^b		Nominal median particle weight W ₅₀ ^{c,d} Weight ^a	d ₁₅ ^c		d ₆₀ ^c		d ₁₀₀ ^c
Class ^a	Size (inches)		Min	Max	Min	Max	Max
I	6	20 lb	3.7	5.2	5.7	6.9	12.0
II	9	60 lb	5.5	7.8	8.5	10.5	18.0
III	12	150 lb	7.3	10.5	11.5	14.0	24.0
V	18	1/4 ton	11.0	15.5	17.0	20.5	36.0
VII	24	1/2 ton	14.5	21.0	23.0	27.5	48.0

^aUse Class 8 RSP fabric.

^bIntermediate or B dimension (i.e., width) where A dimension is length and C dimension is thickness.

^cd%, where % denotes the percentage of the total weight of the graded material.

^dValues shown are based on the minimum and maximum particle diameters shown and an assumed specific gravity of 2.65. Weight will vary based on specific gravity of rock available for the project.

Replace the table in section 72-3.03E with:

07-15-16

Minimum Concrete Penetration

	Rock class				
	VII	V	III	II	I
Penetration (inches)	18	14	10	8	6

^^

73 CONCRETE CURBS AND SIDEWALKS

07-15-16

Replace section 73-3.01A with:

07-15-16

Section 73-3 includes specifications for constructing sidewalks, gutter depressions, island paving, curb ramps, and driveways.

^^

74 PUMPING EQUIPMENT AND CONTROLS

04-15-16

Replace **87-1.03K** in the 4th paragraph of section 74-3.03B(2) with:

04-15-16

^^

80 FENCES

07-15-16

Replace section 80-4 with:

07-15-16

80-4 WILDLIFE EXCLUSION FENCES

80-4.01 GENERAL

80-4.01A General

Section 80-4 includes specifications for constructing wildlife exclusion fences.

Constructing a wildlife exclusion fence includes the installation of any signs specified in the special provisions.

80-4.01B Materials

Each T post must:

1. Comply with ASTM A702
2. Be metal and have an anchor plate
3. Be painted black or galvanized

80-4.01C Construction

Not Used

80-4.01D Payment

Not Used

80-4.02 DESERT TORTOISE FENCES

80-4.02A General

Section 80-4.02 includes specifications for constructing desert tortoise fences.

80-4.02B Materials

80-4.02B(1) Permanent Desert Tortoise Fences

80-4.02B(1)(a) General

Each wire tie and hog ring for a permanent desert tortoise fence must comply with section 80-2.02F.

Each hold down pin must:

1. Be U-shaped, with 2 minimum 6-inch long legs
2. Have pointed ends
3. Be at least 11-gauge wire
4. Be galvanized
5. Be commercial quality

80-4.02B(1)(b) Hardware Cloth

The hardware cloth must:

1. Comply with ASTM A740
2. Be welded or woven galvanized steel wire fabric
3. Be made of at least 14-gauge wire
4. Be 36 inches wide

80-4.02B(1)(c) Barbless Wire

The barbless wire must:

1. Comply with ASTM A641/A641M
2. Be at least 14-gauge wire
3. Have a Class 1 zinc coating

80-4.02B(1)(d) Posts

Each post must:

1. Comply with ASTM F1083
2. Be standard weight, schedule 40 steel pipe with a nominal pipe size of 1 inch
3. Be galvanized steel fence post conforming to ASTM A702

80-4.02B(2) Temporary Desert Tortoise Fences

The materials for a temporary desert tortoise fence must comply with section 80-4.02B(1), except the hardware cloth must be made of at least 16-gauge wire.

80-4.02C Construction

80-4.02C(1) General

Extend the hardware cloth a minimum of 24 inches above the ground.

Plumb the posts and pull the hardware cloth taut. Correct any alignment issues.

80-4.02C(2) Permanent Desert Tortoise Fences

Excavate the ground to form a trench before installing the posts and hardware cloth. Embed the posts at maximum 5-foot intervals into the ground. If T posts are used, use 5-foot lengths and embed the posts to match the above-ground height shown for the posts.

Securely fasten the hardware cloth to the posts with wire ties and to barbless wire with hog rings as shown. Pass the wire ties through the hardware cloth. Encircle the posts and barbless wire with the ties and tie them by twisting a minimum of 3 complete turns.

Bend the twisted ends of the ties down to prevent possible snagging. Close hog rings with their ends overlapping.

Bury the hardware cloth a minimum of 12 inches into the ground. Install the cloth in 1 continuous piece. You may cut the cloth into shorter segments if authorized.

Overlap the hardware cloth segments at posts, with a minimum overlap of 6 inches centered at a post. Wire tie the overlapped cloth to posts as shown. Prevent fraying by threading barbless wire along the vertical edges of the hardware cloth on either side of the post or use 3 equally spaced hog rings (6 hog rings per location) along each wire cloth edge.

Where bedrock or caliche substrate is encountered, use the bent hardware cloth detail if authorized. Transitions from buried-to-bent or bent-to-buried configuration must occur at a post location with a minimum 6-inch overlap of the hardware cloth as shown. The maximum spacing for hold down pins is 24 inches on center. Anchor in place with hold down pins the beginning and end corners of the hardware cloth placed on the ground.

Backfill the removed earth material into the trench created to install the hardware cloth and posts. Use an 8 lb or heavier hand tamper to compact the backfill around the posts and hardware cloth. Install a post at each corner of the cloth segments.

If a gate must be installed, attach the hardware cloth to the gate frame such that there is contact along the entire length of the gate between the finished ground surface and the lower edge of the cloth. Install the gate under section 80-10.

80-4.02C(3) Temporary Desert Tortoise Fences

Fold the horizontal edge of the hardware cloth at a 90° angle toward the tortoise habitat area. Ensure the clearance to the ground at the bend is from 0 to 2 inches.

Where the hardware cloth overlaps, secure the bend piece with one of the following:

1. Barbless wire threaded along the width of the cloth
2. Minimum of 4 hog rings equally spaced along the edge

Fasten the bent piece to the ground with hold down pins pushed completely into the ground.

Add to the end of section 84-8.03A:

07-15-16

The noise level created by the combined grinding activities must not exceed 86 dBA when measured at a distance of 50 feet at right angles to the direction of travel.

Break rumble strips before and after intersections, driveways, railroad crossings, freeway gore areas, and freeway ramps. Place breaks and break distances as shown. You may adjust breaks and the break distances as needed at low-volume driveways or other locations if authorized.

Delete *new* in the 1st paragraph of section 84-8.03B.

07-15-16

Add to the end of section 84-8.03B:

07-15-16

Remove grinding residue under section 13-4.03E(7).

Replace the 1st paragraph of section 84-8.03C with:

07-15-16

Construct rumble strips in the top layer of HMA and asphalt concrete surfacing by the ground-in method.

Add between the 2nd and 3rd paragraphs of section 84-8.03C:

07-15-16

Dispose of the removed material.

Delete the 2nd paragraph of section 84-8.03C.

07-15-16

Replace 37-2 in the 3rd paragraph of section 84-8.03C with:

07-15-16

37-4.02

Replace section 84-8.04 with:

07-15-16

The payment quantity for any type of rumble strip is the length measured by the station along the length of the rumble strip without deductions for gaps between indentations.

Replace the 2nd paragraph of section 84-9.03B with:

04-15-16

Completely remove traffic stripes and pavement markings, including any paint in the gaps, by methods that do not remove pavement to a depth of more than 1/8 inch.

Add between the 2nd and 3rd paragraphs of section 84-9.03B:

04-15-16

Submit your proposed method for removing traffic stripes and pavement markings at least 7 days before starting the removal work. Allow 2 business days for the review.

Remove pavement marking such that the old message cannot be identified. Make any area removed by grinding rectangular. Water must not puddle in the ground areas. Fog seal ground areas on asphalt concrete pavement.

Delete *materially* in the 1st paragraph of section 84-9.03D.

AA

DIVISION X ELECTRICAL WORK

Replace section 86 with:

86 GENERAL

04-15-16

86-1.01 GENERAL

86-1.01A Summary

Section 86 includes general specifications for furnishing electrical equipment and materials.

Electrical equipment and materials must comply with part 4 of the *California MUTCD* and 8 CA Code of Regs, chapter 4, subchapter 5, "Electrical Safety Orders."

Galvanized equipment and materials must comply with section 75-1.02B.

86-1.01B Definitions

accessible pedestrian signal: Accessible pedestrian signal as defined in the *California MUTCD*.

accessible walk indication: Activated audible and vibrotactile action during the walk interval.

actuation: Actuation as defined in the *California MUTCD*.

ambient sound level: Background sound level in dB at a given location.

ambient sound sensing microphone: Microphone that measures the ambient sound level in dB and automatically adjusts the accessible pedestrian signal speaker's volume.

audible speech walk message: Audible prerecorded message that communicates to pedestrians which street has the walk interval.

channel: Discrete information path.

CALiPER: Commercially Available LED Product Evaluation and Reporting. A U.S. Department of Energy program that individually tests and provides unbiased information on the performance of commercially available LED luminaires and lights.

controller assembly: Assembly for controlling a system's operations, consisting of a controller unit and auxiliary equipment housed in a waterproof cabinet.

controller unit: Part of the controller assembly performing the basic timing and logic functions.

correlated color temperature: Absolute temperature in kelvin of a blackbody whose chromaticity most nearly resembles that of the light source.

detector: Detector as defined in the *California MUTCD*.

electrolier: Assembly of a lighting standard and luminaire.

flasher: Device for opening and closing signal circuits at a repetitive rate.

flashing beacon control assembly: Assembly of switches, circuit breakers, terminal blocks, flasher, wiring, and other necessary electrical components housed in a single enclosure for operating a beacon.

house side lumens: Lumens from a luminaire directed to light up areas between the fixture and the pole, such as sidewalks at intersection or areas off the shoulders on freeways.

illuminance gradient: Ratio of the minimum illuminance on a 1-foot square of sign panel to that on an adjacent 1-foot square of sign panel.

inductive loop detector: Detector capable of being actuated by an inductance change caused by a vehicle passing or standing over the loop. An inductive loop detector includes a loop or group of loops installed in the roadway and a lead-in cable installed and connected inside a controller cabinet.

junction temperature: Temperature of the electronic junction of the LED device. The junction temperature is critical in determining photometric performance, estimating operational life, and preventing catastrophic failure of the LED.

L70: Extrapolated life in hours of the luminaire when the luminous output depreciates 30 percent from the initial values.

lighting standard: Pole and mast arm supporting the luminaire.

LM-79: Test method from the Illumination Engineering Society of North America specifying the test conditions, measurements, and report format for testing solid state lighting devices, including LED luminaires.

LM-80: Test method from the Illumination Engineering Society of North America specifying the test conditions, measurements, and report format for testing and estimating the long-term performance of LEDs for general lighting purposes.

luminaire: Assembly that houses the light source and controls the light emitted from the light source.

National Voluntary Laboratory Accreditation Program: U.S. Department of Energy program that accredits independent testing laboratories.

powder coating: Coating applied electrostatically using exterior-grade, UV-stable, polymer powder.

power factor: Ratio of the real power component to the complex power component.

pretimed controller assembly: Assembly operating traffic signals under a predetermined cycle length.

programming mechanism: Device to program the accessible pedestrian signal operation.

pull box: Box with a cover that is installed in an accessible place in a conduit run to facilitate the pulling in of wires or cables.

push button information message: Push button information message as defined in the *California MUTCD*.

push button locator tone: Push button locator tone as defined in the *California MUTCD*.

signal face: Signal face as defined in the *California MUTCD*.

signal head: Signal head as defined in the *California MUTCD*.

signal indication: Signal indication as defined in the *California MUTCD*.

signal section: Signal section as defined in the *California MUTCD*.

signal standard: Pole with or without mast arms carrying 1 or more signal faces.

street side lumens: Lumens from a luminaire directed to light up areas between the fixture and the roadway, such as traveled ways and freeway lanes.

surge protection device: Subsystem or component that protects equipment against short-duration voltage transients in power line.

total harmonic distortion: Ratio of the rms value of the sum of the squared individual harmonic amplitudes to the rms value of the fundamental frequency of a complex waveform.

traffic-actuated controller assembly: Assembly for operating traffic signals under the varying demands of traffic as registered by detector actuation.

traffic phase: Traffic phase as defined in the *California MUTCD*.

vehicle: Vehicle as defined in the *California Vehicle Code*.

vibrotactile pedestrian device: Vibrotactile pedestrian device as defined in the *California MUTCD*.

86-1.01C Submittals

86-1.01C(1) General

Within 15 days after Contract approval, submit a list of equipment and materials you propose to install.

Submit the list before shipping equipment and materials to the job site. The list must include:

1. Manufacturer's name
2. Make and model number
3. Month and year of manufacture
4. Lot and serial numbers
5. Contract number
6. Your contact information

Submit confirmation of the vendor's acceptance of the order for the electrical equipment and materials as an informational submittal.

Submit 3 sets of computer-generated, schematic wiring diagrams for each cabinet.

Diagrams, plans, and drawings must be prepared using graphic symbols in IEEE 315, "Graphic Symbols for Electrical and Electronic Diagrams."

Submit a schedule of values within 15 days after Contract approval.

Do not include costs for the traffic control system in the schedule of values.

Submit a manufacturer's maintenance manual or combined maintenance and operation manual as an informational submittal. The manual must have a master item index that includes:

1. Specifications
2. Design characteristics
3. General operation theory
4. Function of all controls
5. Troubleshooting procedure
6. Parts list, descriptions, stock numbers, and settings
7. Block circuit diagram
8. Layout of components
9. Schematic diagrams

86-1.01C(2) Pull Boxes

Submit the manufacturer's installation instructions for pull boxes, including:

1. Quantity and size of entries that can be made without degrading the strength of the pull box below the load rating
2. Locations where side entries can be made
3. Acceptable method for creating the entry

Submit load-rating test reports for pull boxes from a NRTL.

86-1.01C(3) LED Luminaires

Submit for an LED luminaire:

1. Maximum power in watts
2. Maximum designed junction temperature
3. Heat sink area in square inches

4. Designed junction-to-ambient thermal resistance calculation with thermal resistance components clearly defined
5. L70 in hours when extrapolated for the average nighttime operating temperature
6. Life expectancy based on the junction temperature
7. Manufacturer's data sheet for the power supply, including the rated life

Submit the manufacturer's QC test data for LED luminaires as an informational submittal.

86-1.01C(4) Low-Pressure Sodium Luminaires

Submit the manufacturer's QC test data for low-pressure sodium luminaires as an informational submittal.

86-1.01C(5) Service Equipment Enclosures

Submit shop drawings for a service equipment enclosure to METS.

86-1.01C(6) Signal Heads

Submit a certificate of compliance and the manufacturer's QC test data for signal heads as an informational submittal.

86-1.01C(7) LED Signal Modules

Submit the manufacturer's QC test data for LED signal modules as an informational submittal.

86-1.01C(8) Visors

Submit a certificate of compliance and the manufacturer's QC test data for visors as an informational submittal.

86-1.01C(9) LED Countdown Pedestrian Signal Face Modules

Submit the manufacturer's QC test data for LED countdown pedestrian signal face modules as an informational submittal.

86-1.01C(10) Accessible Pedestrian Signals

Submit the manufacturer's QC test data for accessible pedestrian signals as an informational submittal.

86-1.01D Quality Assurance

86-1.01D(1) General

Electrical equipment must comply with one or more of the following standards:

1. ANSI
2. ASTM
3. EIA/ECIA
4. NEMA
5. NETA
6. UL/NRTL
7. TIA

Materials must comply with:

1. FCC rules
2. ITE standards
3. NEC
4. California Electrical Code

86-1.01D(2) Source Quality Control

Service equipment enclosures and cabinets must be inspected and tested at the source.

86-1.01D(3) Department Acceptance

Deliver material and equipment for testing to METS.

Allow 30 days for testing. The Department notifies you when testing is complete.

If the Department accepts the material or equipment, you must pick it up from the test site and deliver it to the job site.

If the Department rejects material or equipment, remove it within 5 business days after you are notified it is rejected. If it is not removed within that period, the Department may remove it and ship it to you and deduct the costs of labor, material and shipping.

Resubmit a new sample and allow 30 days for retesting. The retesting period starts when the replacement material or equipment is delivered to METS.

86-1.02 MATERIALS

86-1.02A General

Anchor bolts, anchor bars or studs, and nuts and washers must comply with section 75-1.02.

Bolt threads must accept galvanized standard nuts without requiring tools or causing removal of protective coatings.

86-1.02B Conduit and Accessories

86-1.02B(1) General

Conduit and fittings must comply with the requirements shown in the following table:

Conduit and Fitting Requirements	
Type	Requirement
1	Must be hot-dip galvanized rigid steel complying with UL 6 and ANSI C80.1. The zinc coating must comply with copper sulfate test requirements in UL 6. Fittings must be electrogalvanized and certified under UL 514B.
2	Must comply with requirements for Type 1 conduit and be coated with PVC or polyethylene. The exterior thermoplastic coating must have a minimum thickness of 35 mils. The internal coating must have a minimum thickness of 2 mils. Coated conduit must comply with NEMA RN 1, or NRTL PVC-001.
3	Must be Type A, extruded, rigid PVC conduit complying with UL 651 or must be HDPE conduit complying with UL 651A.
4	Must have an inner, flexible metal core covered by a waterproof, nonmetallic, sunlight-resistant jacket, and must be UL listed for use as a grounding conductor. Fittings must be certified under UL 514B.
5	Must be intermediate steel complying with UL 1242 and ANSI C80.6. The zinc coating must comply with copper sulfate test requirements specified in UL 1242. Fittings must be electrogalvanized and certified under UL 514B.

Bonding bushings installed on metal conduit must be insulated and either a galvanized or zinc-alloy type.

86-1.02B(2) Structures Accessories

Steel hangers, steel brackets, and other fittings used to support conduit in or on a wall or bridge superstructure must comply with section 75-3.

Precast concrete cradles for conduit must be made of minor concrete and commercial-quality welded wire fabric. The minor concrete must contain a minimum of 590 lb of cementitious material per cubic yard. The cradles must be moist cured for a minimum of 3 days.

86-1.02C Pull Boxes

86-1.02C(1) General

Pull box cover must have a marking on the top that is:

1. Clearly defined
2. Uniform in depth
3. Parallel to either side
4. 1 to 3 inches in height

Cover marking must be:

1. *SERVICE* for service circuits between a service point and service disconnect
2. *SERVICE IRRIGATION* for circuits from a service equipment enclosure to an irrigation controller
3. *SERVICE BOOSTER PUMP* for circuits from a service equipment enclosure to the booster pump
4. *TDC POWER* for circuits from a service equipment enclosure to telephone demarcation cabinet
5. *LIGHTING* for a lighting system
6. *SIGN ILLUMINATION* for a sign illumination system
7. *SIGNAL AND LIGHTING* for a signal and lighting system
8. *RAMP METER* for a ramp metering system
9. *TMS* for a traffic monitoring station
10. *FLASHING BEACON* for a flashing beacon system
11. *CMS* for a changeable message sign system
12. *INTERCONNECT* for an interconnect conduit and cable system

The load rating must be stenciled on the inside and outside of the pull box and the cover.

If a transformer or other device must be placed in the pull box, include recesses for a hanger.

The hardware must be stainless steel with 18 percent chromium and 8 percent nickel content.

86-1.02C(2) Nontraffic Pull Boxes

A nontraffic pull box and cover must comply with ANSI/SCTE 77, "Specification for Underground Enclosure Integrity," for Tier 22 load rating and must be gray or brown.

Each new pull box must have a cover with an electronic marker cast inside.

A pull box extension must be made of the same material as the pull box. The extension may be another pull box if the bottom edge of the pull box fits into the opening for the cover.

The bolts, nuts, and washers must be a captive design and galvanized. Captive bolts for securing the cover of nontraffic pull boxes must be capable of withstanding a torque from 55 to 60 ft-lb and a minimum pull-out strength of 750 lb.

86-1.02C(3) Traffic Pull Boxes

A traffic pull box and cover must comply with ASTM C857 for HS20-44 loading.

The frame must be anchored to the box with 2-1/4-inch-long concrete anchors with a 1/4 inch diameter. A no. 3-1/2(T) pull box must have 4 concrete anchors, one placed in each corner. No. 5(T) and no. 6(T) pull boxes must have 6 concrete anchors, one placed in each corner and one near the middle of each of the longer sides.

Nuts must be vibration-resistant, zinc-plated, carbon steel and have a wedge ramp at the root of the thread.

Before galvanizing a steel or cast iron cover, the manufacturer must apply the cover marking by one of the following methods:

1. Use a cast iron strip at least 1/4 inch thick with letters raised a minimum of 1/16 inch. Fasten the strip to the cover with 1/4-inch, flathead, stainless steel machine bolts and nuts. Peen the bolts after tightening.
2. Use a sheet steel strip at least 0.027 inch thick with letters raised a minimum of 1/16 inch. Fasten the strip to the cover by spot welding, tack welding, or brazing with 1/4-inch stainless steel rivets or 1/4-inch, roundhead, stainless steel machine bolts and nuts. Peen the bolts after tightening.

The steel cover must be countersunk approximately 1/4 inch to accommodate the bolt head. When tightened, the bolt head must be no more than 1/8 inch above the top of the cover.

86-1.02C(4) Reserved

86-1.02D Tapes

86-1.02D(1) General

Reserved

86-1.02D(2) Pull Tape

Pull tape must be a flat, woven, lubricated, soft-fiber, polyester tape with a minimum tensile strength of 1,800 lb. The tape must have sequential measurement markings every 3 feet.

86-1.02D(3) Reserved**86-1.02E Reserved****86-1.02F Conductors and Cables****86-1.02F(1) Conductors****86-1.02F(1)(a) General**

Reserved

86-1.02F(1)(b) Reserved**86-1.02F(1)(c) Copper Conductors****86-1.02F(1)(c)(i) General**

Copper wire must comply with ASTM B3 and B8.

Conductor must be clearly and permanently marked the entire length of its outer surface with:

1. Manufacturer's name or trademark
2. Insulation-type letter designation
3. Conductor size
4. Voltage
5. Temperature rating
6. Number of conductors for a cable

The minimum insulation thickness and color code requirements must comply with NEC.

A conductor must be UL listed or NRTL certified and rated for 600 V(ac).

Insulation for no. 14 to no. 4 conductors must be one of the following:

1. Type TW PVC under ASTM D2219
2. Type THW PVC
3. Type USE, RHH, or RHW cross-linked polyethylene

The insulation for no. 2 and larger conductors must be one of the above or THWN.

Conductors must be identified as shown in the following table:

Conductor Identification

Circuit	Signal phase or function	Identification			Size
		Insulation color ^d		Band symbols	
		Base	Stripe ^a		
Signals (vehicle) ^{a, b}	2, 6	Red, yel, brn	Blk	2, 6	14
	4, 8	Red, yel, brn	Ora	4, 8	14
	1, 5	Red, yel, brn	None	1, 5	14
	3, 7	Red, yel, brn	Pur	3, 7	14
	Ramp meter 1	Red, yel, brn	None	NBR	14
	Ramp meter 2	Red, yel, brn	Blk	NBR	14
Pedestrian signals	2p, 6p	Red, brn	Blk	2p, 6p	14
	4p, 8p	Red, brn	Ora	4p, 8p	14
	1p, 5p	Red, brn	None	1p, 5p	14
	3p, 7p	Red, brn	Pur	3p, 7p	14
Pedestrian push buttons	2p, 6p	Blu	Blk	P-2, P-6	14
	4p, 8p	Blu	Ora	P-4, P-8	14
	1p, 5p	Blu	None	P-1, P-5	14
	3p, 7p	Blu	Pur	P-3, P-7	14
Traffic signal controller cabinet	Ungrounded circuit conductor	Blk	None	CON-1	6
	Grounded circuit conductor	Wht	None	CON-2	6
Highway lighting pull box to luminaire	Ungrounded - line 1	Blk	None	NBR	14
	Ungrounded - line 2	Red	None	NBR	14
	Grounded	Wht	None	NBR	14
Multiple highway lighting	Ungrounded - line 1	Blk	None	ML1	10
	Ungrounded - line 2	Red	None	ML2	10
Lighting control	Ungrounded - PEU	Blk	None	C1	14
	Switching leg from PEU unit or SM transformer	Red	None	C2	14
Service	Ungrounded - line 1 (signals)	Blk	None	NBR	6
	Ungrounded - line 2 (lighting)	Red	None	NBR	8
Sign lighting	Ungrounded - line 1	Blk	None	SL-1	10
	Ungrounded - line 2	Red	None	SL-2	10
Flashing beacons	Ungrounded between flasher and beacons	Red or yel	None	F-Loc. ^c	14
Grounded circuit conductor	Pedestrian push buttons	Wht	Blk	NBR	14
	Signals and multiple lighting	Wht	None	NBR	10
	Flashing beacons and sign lighting	Wht	None	NBR	12
	Lighting control	Wht	None	C-3	14
	Service	Wht	None	NBR	14
Railroad preemption		Blk	None	R	14
Spares		Blk	None	NBR	14

NBR = No band required PEU=Photoelectric unit

^aOn overlaps, the insulation is striped for the 1st phase in the designation, e.g., phase (2+3) conductor is striped as for phase 2.

^bBand for overlap and special phases as required

^cFlashing beacons having separate service do not require banding.

^dColor Code: Yel-Yellow, Brn-Brown, Blu-Blue, Blk-Black, Wht-White, Ora-Orange, Pur-Purple

The insulation color must be homogeneous throughout the full depth of the insulation. The identification stripe must be continuous throughout the length of the conductor.

86-1.02F(1)(c)(ii) Bonding Jumpers and Equipment Grounding Conductors

A bonding jumper must be copper wire or copper braid of the same cross-sectional area as a no. 8 conductor or larger.

An equipment grounding conductor may be bare or insulated.

86-1.02F(1)(c)(iii) Inductive Loop Conductors

Inductive loop conductor must comply with the requirements shown in the following table:

Conductor Requirements for Inductive Loop Detectors

Loop wire	Requirement
Type 1	Type RHW-USE neoprene-jacketed or Type USE cross-linked polyethylene, insulated, no. 12, stranded copper wire with a minimum 40-mils insulation thickness at any point.
Type 2	Type THWN or Type XHHW, no. 14, stranded copper wire in a plastic tubing. The plastic tubing must be polyethylene or vinyl rated for use at 105 °C and resistant to oil and gasoline. The outside diameter of the tubing must be at most 0.27 inch with a wall thickness of at least 0.028 inch.

86-1.02F(1)(d) Reserved

Reserved

86-1.02F(2) Cables

86-1.02F(2)(a) General

Reserved

86-1.02F(2)(b) Reserved

Reserved

86-1.02F(2)(c) Reserved

86-1.02F(2)(d) Copper Cables

86-1.02F(2)(d)(i) General

The conductor wire size for a detector lead-in cable must comply with the requirements of ASTM B286.

Cable, except a detector lead-in cable, must be clearly and permanently marked the entire length of its outer surface with:

1. Manufacturer's name or trademark
2. Insulation-type letter designation
3. Conductor size
4. Voltage
5. Temperature rating
6. Number of conductors for a cable

86-1.02F(2)(d)(ii) Conductors Signal Cables

A conductors signal cable must have a black polyethylene jacket with an inner polyester binder sheath. The cable jacket must be rated for 600 V(ac) and 75 degrees C. Filler material, if used, must be polyethylene.

The individual conductors in the cable must be solid copper complying with ASTM B286 with Type THWN insulation. The minimum thickness of insulation must comply with NEC for conductor sizes no. 14 to no.10. The minimum thickness of the nylon jacket must be 4 mils.

Cable must comply with the requirements shown in the following table:

Cable type ^a	Conductor quantity and type	Cable jacket thickness (mils)		Maximum nominal outside diameter (inch)	Conductor color code
		Average	Minimum		
3CSC	3 no. 14	44	36	0.40	Blue/black, blue/orange, white/black stripe
5CSC	5 no. 14	44	36	0.50	Red, yellow, brown, black, white
9CSC	8 no. 14 1 no. 12	60	48	0.65	No. 12 - white, no. 14 - red, yellow, brown, black, and red/black, yellow/black, brown/black, white/black stripe
12CSC	11 no. 14 1 no. 12	60	48	0.80	No. 12 - white, no. 14 - red, yellow, brown, red/black stripe, yellow/black stripe, brown/black stripe, black/red stripe, black/white stripe, black, red/white stripe, brown/white stripe
28CSC	27 no. 14 1 no. 10	80	64	0.90	No. 10 - white no. 14 - red/black stripe, yellow/black stripe, brown/black stripe, red/orange stripe, yellow/orange stripe, brown/orange stripe, red/silver stripe, yellow/silver stripe, brown/silver stripe, red/purple stripe, yellow/purple stripe, brown/purple stripe, red/2 black stripes, brown/2 black stripes, red/2 orange stripes, brown/2 orange stripes, red/2 silver stripes, brown/2 silver stripes, red/2 purple stripes, brown/2 purple stripes, blue/black stripe, blue/orange stripe, blue/silver stripe, blue/purple stripe, white/black stripe, black/red stripe, black

86-1.02F(2)(d)(iii) Detector Lead-in Cables

Conductors for a loop detector lead-in cable must be two no. 16, 19-by-29, stranded, tinned copper wires with calculated cross-sectional areas complying with ASTM B286, table 1 and must comply with the requirements shown in the following table:

Conductor Requirements for Loop Detector Lead-In Cables

Lead-in cable	Requirement
Type B	Insulated with 20 mils of high-density polyethylene. Conductors must be twisted together with at least 2 turns per foot, and the twisted pair must be protected with a copper or aluminum polyester shield. A minimum no. 20 copper drain wire must be connected to the equipment ground within the cabinet. Cable must have a high-density polyethylene or high-density polypropylene outer jacket with a nominal thickness of 32 mils. Include an amorphous, interior, moisture penetration barrier of nonhydroscopic polyethylene or polypropylene fillers.
Type C	Comply with International Municipal Signal Association Specification no. 50-2. A minimum no. 20 copper drain wire must be connected to the equipment ground within the cabinet.

86-1.02F(2)(d)(iv) Reserved

86-1.02F(2)(d)(v) Signal Interconnect Cables

A signal interconnect cable must be a 6-pair type with stranded, tinned, copper no. 20 conductors. The insulation for each conductor must be color-coded polypropylene with a minimum 13-mils nominal thickness. The conductors must be in color-coded, twisted pairs. Each pair must be wrapped with an aluminum polyester shield and have a no. 22 or larger, stranded, tinned, copper drain wire inside the shielded pair.

The cable jacket must be black HDPE rated for a minimum of 300 V(ac) and 60 degrees C. The jacket must have a minimum nominal wall thickness of 40 mils.

86-1.02F(2)(e) Reserved

86-1.02G Equipment Identification Characters

Equipment identification characters must be 2-1/2 inch, series D lettering, except on wood poles, they must be 3-inch lettering.

The characters must be self-adhesive reflective labels or paint, except on wood poles, they must be embossed on aluminum.

86-1.02H Splicing Materials

Splicing materials include:

1. Connectors
2. Electrical insulating coating
3. PVC electrical tape
4. Butyl rubber stretchable tape
5. PVC pressure-sensitive adhesive tape
6. Heat shrink tubing

Connectors must be C-shaped compression or butt type.

Electrical insulating coating must be a fast drying sealant with low nontoxic fumes.

PVC electrical tape must have a minimum thickness of 80 mils.

Butyl rubber stretchable tape with liner must have a minimum thickness of 120 mils.

PVC pressure-sensitive adhesive electrical tape must have a minimum thickness of 6 mils.

Electrical tapes must be self-fusing, oil- and flame-resistant, synthetic rubber and be UL listed or NRTL certified.

Heat-shrink tubing must be made of irradiated polyolefin tubing with a minimum wall thickness of 40 mils before contraction and an adhesive mastic inner wall. When heated, the inner wall must melt and fill the crevices and interstices of the covered splice area and the outer wall must shrink to form a waterproof insulation.

Heat-shrink tubing must comply with the requirements for extruded, insulating tubing at 600 V(ac) specified in UL Standard 468D and ANSI C119.1 and the requirements shown in the following table:

Heat-Shrink Tubing Requirements

Quality characteristic	Requirement
Shrinkage ratio of supplied diameter ^a (max, %)	33
Dielectric strength (min, kV/in)	350
Resistivity (min, Ω/in)	25 x 10 ¹³
Tensile strength (min, psi)	2,000
Operating temperature (°C)	-40–90 (135 °C in emergency)
Water absorption (max, %)	0.5

^aWhen heated to 125 °C and allowed to cool to 25 °C

86-1.02I Connectors and Terminals

A connector and terminal must comply with SAE-AS7928 and be a crimp type, rated for 600 V(ac) and either UL listed or NRTL certified.

86-1.02J Standards, Poles, Pedestals, and Posts

Standards for signals, lighting, and flashing beacons, poles for closed circuit television, pedestals for cabinets, posts for extinguishable message sign and posts for pedestrian push button assemblies must comply with section 56-3.

86-1.02K Luminaires

86-1.02K(1) General

Luminaire must be either LED or low-pressure-sodium type.

86-1.02K(2) LED Luminaires

LED luminaire must be on the Authorized Material List for LED luminaires and must:

1. Be self-contained, not requiring assembly.
2. Comply with UL 1598 for luminaires in wet locations.
3. Have a power supply with:
 - 3.1. ANSI/IEC rating of at least IP65.
 - 3.2. 2 leads to accept standard 0-10 V(dc).
 - 3.3. Dimming control compatible with IEC 60929, Annex E. If the control leads are open or the analog control signal is lost, the circuit must default to 100-percent power.
 - 3.4. Case temperature self rise of 77 degrees F or less above ambient temperature in free air with no additional heat sinks.
4. Weigh no more than 35 lb.
5. Have a minimum operating life of 63,000 hours when operated for an average time of 11.5 hours at an average temperature of 70 degrees F.
6. Be designed to operate over a temperature range from -40 to 130 degrees F.
7. Be operationally compatible with photoelectric controls.
8. Have a correlated color temperature range from 3,500 to 6,500 K and a color rendering index of 65 or greater.
9. Have a maximum-effective projected area of 1.4 sq ft when viewed from either side or end.
10. Have a housing color that matches a color no. 26152 to 26440, 36231 to 36375, or 36440 of FED-STD-595.
11. Have an ANSI C136.41-compliant, locking-type, photocontrol receptacle with dimming connections and a watertight shorting cap.
12. Comply with LM-79, LM-80 and California Test 611.

The individual LEDs must be connected such that a catastrophic loss or a failure of 1 LED does not result in the loss of more than 20 percent of the luminous output of the luminaire.

The luminaire must be permanently marked inside the unit and outside of its packaging box. Marking consists of:

1. Manufacturer's name or trademark

2. Month and year of manufacture
3. Model, serial, and lot numbers
4. Rated voltage, wattage, and power in VA

An LED luminaire's onboard circuitry must include a surge protection device to withstand high-repetition noise transients caused by utility line switching, nearby lightning strikes, and other interferences. The device must protect the luminaire from damage and failure due to transient voltages and currents as defined in Tables 1 and 4 of ANSI/IEEE C64.41.2 for location category C-High. The surge protection device must comply with UL 1449 and ANSI/IEEE C62.45 based on ANSI/IEEE C62.41.2 definitions for standard and optional waveforms for location category C-High.

An LED luminaire and its associated onboard circuitry must comply with the Class A emission limits under 47 CFR 15(B) for the emission of electronic noise.

The fluctuations of line voltage must have no visible effect on the luminous output.

The operating voltage may range from 120 to 480 V(ac), 60 ± 3 Hz. Luminaire must operate over the entire voltage range or the voltage range must be selected from one of the following:

1. Luminaire must operate over a voltage range from 95 to 277 V(ac). The operating voltages for this option are 120 V(ac) and 240 V(ac).
2. Luminaire must operate over a voltage range from 347 to 480 V(ac). The operating voltage for this option is 480 V(ac).

LED luminaire must have a power factor of 0.90 or greater. The total harmonic distortion, current, and voltage induced into a power line by a luminaire must not exceed 20 percent. The L70 of the luminaire must be the minimum operating life or greater. Illuminance measurements must be calibrated to standard photopic calibrations.

The maximum power consumption and maintained illuminance of the LED luminaires must comply with the isofootcandle curves as shown.

LED luminaire must not allow more than 10 percent of the rated lumens to project above 80 degrees from vertical and 2.5 percent of the rated lumens to project above 90 degrees from vertical.

Luminaire must have passive thermal management with enough capacity to ensure proper heat dissipation and functioning of the luminaire over its minimum operating life. The maximum junction temperature for the minimum operating life must not exceed 221 degrees F.

The junction-to-ambient thermal resistance must be 95 degrees F per watt or less. The use of fans or other mechanical devices is not allowed for cooling the luminaire. The heat sink must be made of aluminum or other material of equal or lower thermal resistance. The luminaire must contain circuitry that automatically reduces the power to the LEDs so the maximum junction temperature is not exceeded when the ambient temperature is 100 degrees F or greater.

The luminaire's housing must be fabricated from materials designed to withstand a 3,000-hour salt spray test under ASTM B117. All aluminum used in housings and brackets must be made of a marine-grade alloy with less than 0.2 percent copper. All exposed aluminum must be anodized. A chromate conversion undercoating must be used underneath a thermoplastic polyester powder coat.

The housing must be designed to prevent the buildup of water on its top surface. Exposed heat sink fins must be oriented to allow water to run off the luminaire and carry dust and other accumulated debris away from the unit. The optical assembly of the luminaire must be protected against dust and moisture intrusion to at least an UL 60529 rating of IP66. The power supply enclosure must be protected to at least an UL 60529 rating of IP43.

The housing must have a slip fitter capable of being mounted on a 2-inch-diameter pipe tenon. Slip fitter must:

1. Fit on mast arms with outside diameters from 1-5/8 to 2-3/8 inches
2. Be adjustable to a minimum of ±5 degrees from the axis of the tenon in a minimum of 5 steps: +5, +2.5, 0, -2.5, -5
3. Have clamping brackets that:

- 3.1. Are made of corrosion-resistant materials or treated to prevent galvanic reactions
- 3.2. Do not bottom out on the housing bosses when adjusted within the designed angular range
- 3.3. Do not permanently set in excess of 1/32 inch when tightened

Each refractor or lens must be made of UV-inhibiting high-impact plastic, such as acrylic or polycarbonate, or heat- and impact-resistant glass. The refractor or lens must be resistant to scratching. Polymeric materials, except for the lenses of enclosures containing either the power supply or electronic components of the luminaire, must be made of UL94 V-0 flame-retardant materials.

An LED luminaire and its internal components must be able to withstand mechanical shock and vibration.

If the components are mounted on a down-opening door, the door must be hinged and secured to the luminaire's housing separately from the refractor or flat lens frame. The door must be secured to the housing to prevent accidental opening. A safety cable must mechanically connect the door to the housing.

An LED luminaire must have a barrier-type terminal block secured to the housing to connect field wires. The terminal screws must be captive and equipped with wire grips for conductors up to no. 6.

The conductors and terminals must be identified and marked.

86-1.02K(3) Low-Pressure Sodium luminaires

A low-pressure sodium luminaire must be an enclosed cutoff or semi-cutoff type and be self-contained, not requiring assembly.

The housing must be either (1) a minimum 1/16-inch-thick, corrosion-resistant, die-cast aluminum sheet and plate with concealed continuous welds or (2) a minimum 3/32-inch-thick, acrylonitrile-butadiene-styrene sheet material on a cast aluminum frame. The housing must provide mounting for all electrical components and a slip fitter. The housing must be divided into optical and power compartments that are individually accessible for service and maintenance.

The painted exterior surface of the luminaire must be finished with a fused coating of electrostatically applied polyester powder paint or other UV-inhibiting film. The color must be aluminum gray.

A sealing ring must be installed in the pipe tenon opening to prevent the entry of water and insects into the power and optical compartments. The ring must be made of high-temperature neoprene or equal material.

The power unit assembly must be accessible through a weather-tight, hinged cover secured to the housing with spring latches or captive screws.

The luminaire's hardware must be stainless steel or cadmium plated. Removable components must be secured with machine screws or bolts instead of sheet metal screws.

A semi-cutoff luminaire or a molded refractor-style cutoff luminaire must include a refractor. Other cutoff luminaires must include a flat lens. The refractor assembly and flat lens assembly must be designed to rigidly maintain their shape and be hinged and secured to the housing with spring latches.

The refractor must be either a 1-piece injection-molded polycarbonate with a minimum thickness of 3/32 inch or a 1-piece injection-molded acrylic with a minimum thickness of 1/8 inch. Alternate methods of manufacturing the refractor may be authorized provided minimum specified thicknesses are maintained.

The flat lens must be a 1-piece polycarbonate with a minimum thickness of 3/32 inch, mounted to a metal frame.

The lamp socket must be made of high-temperature, flame-retardant, thermoset material with self-wiping contacts or an equal. The socket must be rated for 660 W and 1,000 V(ac). The position of the socket and support must maintain the lamp in the correct relationship with the reflector and refractor for the designed light distribution pattern. The reflector may be an integral part of the housing.

The luminaire must comply with the isofootcandle curves as shown.

Low-pressure sodium lamp must:

1. Be a 180 W, single-ended, bayonet-base, tubular, gas-discharge lamp

2. Maintain a minimum of 93 percent of its initial lumens over its rated life
3. Reach 80 percent of its light output within 10 minutes
4. Restrike within 1 minute after a power outage or voltage drop at the lamp socket
5. Have ANSI L74/E designation

The lamp operating position must be at ± 20 degrees from the horizontal.

Lamp must comply with the minimum performance requirements shown in the following table:

Minimum Performance Requirements	
Quality characteristic	Requirement
Initial lumens (lm)	33,000
Rated average life at 10 h/start (h)	18,000

The low-pressure sodium lamp ballast must be an autotransformer or high-reactance type. The power factor must be not less than 90 percent when the ballast is operated at the nominal line voltage with a nominally-rated reference lamp. The lamp wattage regulation spread must not vary by more than ± 6 percent for ± 10 percent input voltage variation from nominal through life.

At the line voltage, the ballast must have a lamp current crest factor not exceeding 1.8 and ballast loss not exceeding 24 percent for a 180 W ballast.

The ballast must include a multi-circuit connector for quick disconnection.

86-1.02K(4) Reserved

86-1.02L Reserved

86-1.02M Photoelectric Controls

Photoelectric control types are as shown in the following table:

Photoelectric Control Types	
Control type	Description
I	Pole-mounted photoelectric unit. Test switch housed in an enclosure.
II	Pole-mounted photoelectric unit. Contactor and test switch located in a service equipment enclosure.
III	Pole-mounted photoelectric unit. Contactor and a test switch housed in an enclosure.
IV	A photoelectric unit that plugs into a NEMA twist-lock receptacle, integral with the luminaire.
V	A photoelectric unit, contactor, and test switch located in a service equipment enclosure.

The pole-mounted adaptor for Type I, II, and III photoelectric controls must include a terminal block and cable supports or clamps to support the wires.

The enclosure for Type I and III photoelectric controls must be a NEMA 3R type. The enclosure must have a factory-applied, rust-resistant prime coat and finish coat. The enclosure must be hot-dip galvanized or painted to match the color of the lighting standard.

Photoelectric unit must:

1. Have a screen to prevent artificial light from causing cycling.
2. Have a rating of 60 Hz, 105-130 V(ac), 210-240 V(ac), or 105-240 V(ac).
3. Operate at a temperature range from -20 to 55 degrees C.
4. Consume less than 10 W.
5. Be a 3-prong, twist-lock type with a NEMA IP 65 rating, ANSI C136.10-compliant
6. Have a fail-on state
7. Fit into a NEMA-type receptacle
8. Turn on from 1 to 5 footcandles and turn off from 1.5 to 5 times the turn-on level. Measurements must be made by procedures in *EEI-NEMA Standards for Physical and Electrical Interchangeability of Light-Sensitive Control Devices Used in the Control of Roadway Lighting*.

Type I, II, III, and V photoelectric controls must have a test switch to allow manual operation of the lighting circuit. Switch must be:

1. Single-hole mounting, toggle type
2. Single pole and single throw
3. Labeled *Auto-Test* on a nameplate

Photoelectric control's contactor must be:

1. Normally open
2. Mechanical-armature type with contacts of fine silver, silver alloy, or equal or better material
3. Installed to provide a minimum space of 2-1/2 inches between the contactor terminals and the enclosure's sides

The terminal blocks must be rated at 25 A, 600 V(ac), molded from phenolic or nylon material, and be the barrier type with plated-brass screw terminals and integral marking strips.

86-1.02N Fused Splice Connectors

The fused splice connector for 240 and 480 V(ac) circuits must simultaneously disconnect both ungrounded conductors. The connector must not have exposed metal parts except for the head of the stainless steel assembly screw. The head of the assembly screw must be recessed a minimum of 1/32 inch below the top of the plastic boss that surrounds the head.

The connector must protect the fuse from water or weather damage. Contact between the fuse and fuse holder must be spring loaded.

Fuses must:

1. Be standard, midget, ferrule type
2. Have a nontime-delay feature
3. Be 3/32 by 1-1/2 inches

86-1.02O Grounding Electrodes

Grounding electrode must be:

1. 1 piece
2. Minimum 10-foot length of one of the following:
 - 2.1. Galvanized steel rod or pipe not less than 3/4 inch in diameter
 - 2.2. Copper clad steel rod not less than 5/8 inch in diameter

86-1.02P Enclosures

86-1.02P(1) General

The enclosures must be rated NEMA 3R and include a dead front panel and a hasp with a 7/16-inch-diameter hole for a padlock.

The enclosure's machine screws and bolts must not protrude outside the cabinet wall.

The fasteners on the exterior of an enclosure must be vandal resistant and not be removable. The exterior screws, nuts, bolts, and washers must be stainless steel.

86-1.02P(2) Service Equipment Enclosures

A service equipment enclosure must be factory wired and manufactured from steel and galvanized or have factory-applied, rust-resistant prime and finish coats, except Types II and III.

Type II and III service equipment enclosures must:

1. Be made of 0.125-inch minimum thickness 5052-H32 aluminum sheet complying with ASTM B209.
2. Be manufactured using gas metal arc welding with bare aluminum welding electrodes. The electrodes must comply with AWS A5.10 Class ER5356.

3. Be manufactured using welding procedures, welders, and welding operators that comply with the requirements for welding procedures, welders, and welding operators in AWS B2.1, "Specification for Welding Procedure and Performance Qualification."
4. Have full-seal weld exterior seams.
5. Exterior welds must be ground smooth and edges filed to a radius of at least 0.03 inch.
6. Have a surface finish that complies with MIL-A-8625 for a Type II, Class I coating, except the anodic coating must have a minimum thickness of 0.0007 inch and a minimum coating weight of 0.001 oz/sq in.

If a Type III enclosure houses a transformer of more than 1 kVA, the enclosure must have effective screened ventilation louvers of no less than 50 sq. in for each louver. The framed screen must be stainless no. 304 with a no. 10 size mesh and secured with at least 4 bolts.

The dead front panel on a Type III service equipment enclosure must have a continuous stainless steel or aluminum piano hinge. The panel must be secured with a latch or captive screws. No live part must be mounted on the panel.

The enclosure must be watertight and marked as specified in NEC to warn of potential electric-arc flash hazards.

Internal conductors for the photoelectric control unit must be 600 V(ac), 14 AWG (THHN) stranded machine tool wire. Where subject to flexing, 19 stranded wire must be used.

The meter area must be have a sealable, lockable, weather-tight cover that can be removed without the use of tools.

For Type III-A, III-B, and III-C enclosures, the meter socket must be a 5-clip type, and the landing lug must be suitable for multiple conductors.

For a Type III-D enclosure, the meter socket must be a 7-clip type, and the landing lug must be suitable for multiple conductors. The pedestal must comply with the Electric Utility Service Equipment Requirements Committee drawing no. 308 or 309.

Landing lugs must be (1) sized for the incoming service utility conductors, (2) compatible with either copper or aluminum conductors, and (3) made of copper or tin-plated aluminum. Live parts of the electrical equipment must be guarded against accidental contact.

The main and neutral busses of the enclosure must be made of tin-plated copper, be rated for 125 A, and be suitable for copper or aluminum conductors.

Each service equipment enclosure must have up to 2 main circuit breakers that will simultaneously disconnect ungrounded service-entrance conductors.

Circuit breaker for a service equipment enclosure must:

1. Be quick-break on either automatic or manual operation
2. Be trip indicating
3. Be internal-trip type
4. Be UL listed or NRTL certified and comply with UL 489 or equal
5. Be clearly marked with the frame size
6. Have an operating mechanism that is enclosed and trip-free from the operating handle on overload
7. Have the trip rating clearly marked on the operating handle
8. Have an interior made of copper

Circuit breakers used as disconnects must have a minimum interrupting capacity of 10,000 A, rms.

The interior of the enclosure must accept plug-in circuit breakers. A minimum of 6 standard single-pole circuit breakers, 3/4" nominal, must be provided for branch circuits.

Identify each circuit breaker and component by description using an engraved phenolic nameplate attached with stainless steel rivets or screws.

Nameplate must be installed:

1. Adjacent to the breaker on the dead front panel. The characters must be a minimum of 1/8 inch high.
2. Adjacent to the component on the back panel. The characters must be a minimum of 1/8 inch high.
3. At the top exterior of the door panel. The nameplate must include the system number, voltage, and number of phases engraved in minimum 3/16-inch-high characters.

A plastic-laminated wiring diagram must be attached inside the enclosure with brass eyelets by a UL-listed or NRTL-certified method.

86-1.02P(3) Lighting and Sign Illumination Enclosures

A lighting and sign illumination enclosure must be manufactured from steel and either galvanized, cadmium plated, or powder coated.

86-1.02Q Cabinets

86-1.02Q(1) General

Cabinets must be factory wired except for battery backup system cabinets.

The fasteners on the exterior of a cabinet, except for battery backup system cabinets, must be removable and vandal resistant. The exterior screws, nuts, bolts, and washers must be stainless steel.

Terminal blocks, circuit breakers, and a power supply must be UL approved.

86-1.02Q(2) Department-Furnished Controller Cabinets

A Department-furnished controller assembly consists of a Model 170E or 2070E controller unit, a wired controller cabinet, and all auxiliary equipment required to operate the system. The Department does not furnish anchor bolts.

86-1.02Q(3) Controller Cabinets

The controller cabinet must be a Model 334L, comply with TEES, and be on the Authorized Material List for traffic signal control equipment. The cabinet must have 3 drawer shelves. Each shelf must be attached to the tops of 2 supporting angles with 4 screws.

86-1.02Q(4) Telephone Demarcation Cabinets

86-1.02Q(4)(a) General

The doors of a telephone demarcation cabinet must be attached using continuous stainless steel piano hinges.

86-1.02Q(4)(b) Type A Telephone Demarcation Cabinets

Reserved

86-1.02Q(4)(c) Type B Telephone Demarcation Cabinets

A Type B telephone demarcation cabinet consists of a mounting panel, outlets, circuit breaker, fan, dead front plates, and fuse.

The mounting panel must be made of 3/4-inch-thick ACX-grade plywood.

The mounting panel must be fastened to the cabinet with nuts, lock washers, and flat washers to 10 welded studs.

The cabinet must be made of 0.125-inch-thick anodized aluminum.

The cabinet door must be hung and secured with drawn latches, lockable with a padlock. The padlock latches must each have a minimum 7/16-inch-diameter hole.

Ventilation louvers must be located on the door.

The fan must be located in a ventilator housing and be controlled thermostatically. The thermostat control must have a range from 80 to 130 degrees F.

The thermostat and fan circuit must be protected with a fuse rated for 175 percent of the motor capacity. The fan capacity must be a minimum 25 cfm.

86-1.02Q(4)(d) Type C Telephone Demarcation Cabinets

Reserved

86-1.02Q(5) Battery Backup System Cabinets

The cabinet for a battery backup system must comply with TEES and be on the Authorized Material List for traffic signal control equipment.

86-1.02R Signal Heads

86-1.02R(1) General

A signal head consists of a signal mounting assembly, backplate, and signal face.

The head must have a terminal block attached to the back of one housing. The terminal block must have enough positions to accommodate all indications. Each position must be permanently labeled for the indications used.

The metal signal heads must not fracture or deflect more than half the lens diameter when tested under California Test 666.

The plastic signal heads must not fracture or deflect when tested under California Test 605.

The deflection must not be more than 10 degrees in either the vertical or horizontal plane after the wind load has been removed from the front of the signal face or more than 6 degrees in either the vertical or horizontal plane after the wind load has been removed from the back of the signal face.

86-1.02R(2) Signal Mounting Assemblies

Signal mounting assembly must include:

1. 1-1/2-inch-diameter steel pipe or galvanized conduit
2. Pipe fitting made of ductile iron, galvanized steel, bronze, or aluminum alloy, Type AC-84B, no. 380
3. Mast arm and post-top slip fitters and terminal compartments made of cast bronze or hot-dip galvanized ductile iron

The horizontal distance between the vertical centerlines of the terminal compartment or slip fitter and of each signal face must not exceed 11 inches except where required for proper signal face alignment or to allow programming of programmed visibility signal sections.

The mounting assembly must be watertight and free of sharp edges or protrusions that might damage conductor insulation. The assembly must have positive-locking serrated fittings that prevent signal faces from rotating when the fittings are mated with similar fittings on the faces.

Each terminal compartment must be fitted with a terminal block having a minimum of 12 positions, each with 2 screw-type terminals. Each terminal must accommodate at least five no. 14 conductors. The terminal compartment must have a cover for easy access to the terminal block.

86-1.02R(3) Backplates

The backplate material must be a homogeneous black color with a lusterless finish.

A metal backplate must be made of a minimum 1/16-inch-thick 3001-14 aluminum.

A plastic backplate must have a minimum thickness of 1/16 inch and be formed from sheet plastic or assembled from extruded, molded, or cast plastic sections. Sections must be factory joined using one of the following:

1. Appropriate solvent cement.
2. Aluminum rivets and washers painted or permanently colored to match the backplate.
3. No. 10 machine screws with flat washers, lock washers, and nuts painted to match the backplate.

Each plastic backplate must be secured to the plastic signal face such that it resists removal or permanent deformation.

86-1.02R(4) Signal Faces

Signal face consists of signal sections with signal housings, LED modules, and visors.

Signal face must:

1. Be adjustable and allow for 360-degree rotation about the vertical axis
2. Comply with ITE publications ST-052-E, *Vehicle Traffic Control Signal Heads: Light Emitting Diode (LED) Circular Signal Supplement* and ST-054, *Vehicle Traffic Control Signal Heads: Light Emitting Diode (LED) Vehicle Arrow Traffic Signal Supplement*
3. Be sealed with a neoprene gasket at the top opening

A metal signal face must have a metal backplate and visor.

A plastic signal face must have a plastic backplate and visor.

If a signal face is supported by a Type MAS slip fitter, spacers are required between the 2 sections. The spacers must be made of the same material as the housing. The vertical dimension of the spacers must allow proper seating of the serrations between the slip fitter and the 2 sections. The 2 sections must be joined with at least two no. 10 minimum machine screws through holes near the front of the housing and the spacers and matching holes in a reinforcing plate installed in the housing.

86-1.02R(4)(a) Signal Sections

86-1.02R(4)(a)(i) General

Signal section must have:

1. Opening at the top and bottom for a 1-1/2-inch pipe
2. Maximum height of 10-1/4 inches for an 8-inch section and 14-3/4 inches for a 12-inch section
3. Hinge pins, door-latching devices, and other exposed hardware manufactured of Type 304/304L or 305 stainless steel
4. Interior screws and fittings manufactured of stainless steel or steel with a corrosion-resistant plating or coating
5. Gaskets made of a material that is not degraded if installed in a section with metal or plastic housing

Sections must be capable of being joined together to form a signal face in any combination. This interchangeability is not required between metal and plastic sections.

Each section must be joined to an adjacent section by one of the following:

1. Minimum of 3 machine screws for 8-inch sections and 4 machine screws for 12-inch sections, installed through holes near the front and back of the housing. Each screw must be a no. 10 and have a nut, flat washer, and lock washer.
2. 2 machine screws, each with a nut, flat washer, and lock washer, installed through holes near the front of the housing and a fastener through the 1-1/2-inch pipe opening. The fastener must have 2 large, flat washers to distribute the load around the pipe's opening and 3 carriage bolts, each with a nut and lock washer. The minimum screw size must be no. 10, and the carriage bolt size must be 1/4 inch.

The holes for the machine screws must be either cast or drilled during signal section fabrication. Each hole must be surrounded by a minimum 1/8-inch-wide boss to allow contact between signal sections about the axis of the hole.

A serrated nylon washer must be inserted between each plastic signal section and the metal mounting assembly. Each serrated nylon washer must be from 3/16 to 1/4 inch thick. The serrations must match those on the signal section and the mounting assembly.

86-1.02R(4)(a)(ii) Programmed Visibility Signal Sections

Programmed visibility signal section must have:

1. Nominal 12-inch-diameter circular or arrow indication
2. Cap visor
3. Adjustable connection that:
 - 3.1. Provides incremental tilting from 0 to 10 degrees above or below the horizontal
 - 3.2. Maintains a common vertical axis through couplers and mountings

The terminal connection must allow external adjustment about the mounting axis in 5-degree increments.

The visibility of each signal section must be capable of adjustment or programming within the section.

The adjustment for the section must be preset at 4 degrees below the horizontal.

86-1.02R(4)(a)(iii) Signal Housings

The signal housing must:

1. Be die-cast aluminum, permanent mold-cast aluminum, or if specified, structural plastic
2. Comply with ITE publications ST-052-E, *Vehicle Traffic Control Signal Heads: Light Emitting Diode (LED) Circular Signal Supplement* and ST-054, *Vehicle Traffic Control Signal Heads: Light Emitting Diode (LED) Vehicle Arrow Traffic Signal Supplement* if made of die-cast or permanent mold-cast aluminum
3. Have a 1-piece, hinged, square-shaped door that is:
 - 3.1. Designed to allow access for replacement of modules without the use of tools
 - 3.2. Secured such that it remains closed during loading tests
4. Have a watertight module or lens mounted in the door
5. Have a terminal block attached to the back, with the terminals permanently labeled for conductors to facilitate field wiring

Each housing must have reinforcement plates. Reinforcement plates must be either sheet aluminum, galvanized steel, or cast aluminum. Each plate must have a minimum thickness of 0.11 inch and a hole concentric with a 1-1/2-inch pipe-mounting hole in the housing. Reinforcement plates must be placed as specified in the following table:

Reinforcement Plate Placement

Material	Placement
Sheet aluminum	Inside and outside of housing
Galvanized steel	Inside of housing
Cast aluminum	Outside of housing

Reinforcement plates placed outside of the housing must be finished to match the signal housing color and be designed to allow a proper serrated coupling between the signal face and the mounting hardware. A minimum of three no. 10 machine screws must be installed through holes in each plate and matching holes in the housing. Each screw must have a round or binder head, a nut, and a lock washer.

A metal housing must have a metal visor.

Plastic housing must:

1. Be molded in a single piece or fabricated from 2 or more pieces joined into a single piece
2. Be a black color throughout, including the door, matching color no. 17038, 27038, or 37038 of FED-STD-595
3. Have UV stability
4. Be self-extinguishing

If reinforcing webs are used to connect the back of the housing to the top, bottom, and sides of the adjacent housing, reinforcement plates are not required.

The exterior of the housing must be painted as specified in sections 78-4.08 and 59.

86-1.02R(4)(b) LED Signal Modules

An LED signal module must be on the Authorized Material List for LED traffic signal modules.

An LED signal module must comply with ITE publications ST-052-E, *Vehicle Traffic Control Signal Heads: Light Emitting Diode (LED) Circular Signal Supplement* and ST-054, *Vehicle Traffic Control Signal Heads: Light Emitting Diode (LED) Vehicle Arrow Traffic Signal Supplement*, except:

1. Maximum module weight must be 4 lb
2. Module must be a sealed unit with:

- 2.1. 2 color-coded conductors for the power connection except lane control modules must use 3 color-coded conductors
- 2.2. Printed circuit board that complies with TEES, chapter 1, section 6
- 2.3. Lens that is:
 - 2.3.1. Convex or flat with a smooth outer surface
 - 2.3.2. Made of UV-stabilized plastic or glass
- 2.4. 1-piece EPDM gasket
3. Module must include 3-foot-long conductors with attached quick-disconnect terminals
4. Identification must include:
 - 4.1. Month and year of manufacture
 - 4.2. 1-inch-diameter symbol of the module type with the module color written adjacent to the symbol in 0.50-inch-high letters
5. LED must be the ultra-bright type rated for 100,000 hours of continuous operation
6. Module must have an integral power supply

Individual LEDs must be wired such that a loss or failure of 1 LED will not result in a loss of more than 5 percent of the module's light output. Failure of an individual LED in a string must not result in a loss of an entire string or other indication.

The symbol for a 12-inch U-turn section must be a 15/16-inch-wide inverted *U* with an arrow on the left end.

A lane control section must be a combination module with a red *X* and green arrow. The conductor function and color code must be as shown in the following table:

Conductor Function and Color Code

Function	Color
Neutral	White
Red <i>X</i>	Red
Green arrow	Brown

The minimum power consumption for an LED signal module must be 5 W.

The maximum power consumption for an LED signal module must be as shown in the following table:

Maximum Power Consumption

LED signal module type	Power consumption (W)					
	Red		Yellow		Green	
	25 °C	74 °C	25 °C	74 °C	25 °C	74 °C
8-inch circular	8	13	13	16	12	12
12-inch circular	11	17	22	25	15	15
12-inch arrow	9	12	10	12	11	11
12-inch U-turn	9	12	10	12	11	11
Bicycle	11	17	22	25	15	15
Programmed visibility	11	17	22	25	15	15
Lane control (<i>X</i>)	9	12	--	--	--	--
Lane control (<i>Arrow</i>)	--	--	--	--	11	11

Red and green LED signal modules operating over a temperature range from -40 to 74 degrees C and yellow LED signal modules operating at 25 degrees C must maintain the minimum illumination values for 48 months as shown in the following tables:

Minimum Maintained Intensities for Circular Indications

Angle (v,h)	Intensities (cd)					
	8-inch			12-inch		
	Red	Yellow	Green	Red	Yellow	Green
2.5, ±2.5	133	267	267	339	678	678
2.5, ±7.5	97	194	194	251	501	501
2.5, ±12.5	57	113	113	141	283	283
2.5, ±17.5	25	48	48	77	154	154
7.5, ±2.5	101	202	202	226	452	452
7.5, ±7.5	89	178	178	202	404	404
7.5, ±12.5	65	129	129	145	291	291
7.5, ±17.5	41	81	81	89	178	178
7.5, ±22.5	18	37	37	38	77	77
7.5, ±27.5	10	20	20	16	32	32
12.5, ±2.5	37	73	73	50	101	101
12.5, ±7.5	32	65	65	48	97	97
12.5, ±12.5	28	57	57	44	89	89
12.5, ±17.5	20	41	41	34	69	69
12.5, ±22.5	12	25	25	22	44	44
12.5, ±27.5	9	16	16	16	32	32
17.5, ±2.5	16	32	32	22	44	44
17.5, ±7.5	14	28	28	22	44	44
17.5, ±12.5	10	20	20	22	44	44
17.5, ±17.5	9	16	16	22	44	44
17.5, ±22.5	6	12	12	20	41	41
17.5, ±27.5	4	9	9	16	32	32

Minimum Maintained Luminance for Indications

Indication type	Luminance (fL)		
	Red	Yellow	Green
Arrow	1,610	3,210	3,210
U-turn	1,610	3,210	3,210
Bicycle	1,610	1,610	1,610
Lane control (X)	1,610	--	--
Lane control (Arrow)	--	--	1,610

Minimum Maintained Luminance for Programmed Visibility Indications

Indication type	Luminance (cd)		
	Red	Yellow	Green
PV at angle v=2.5, h=±2.5	314	314	314

Conductors must be prewired to the terminal block.

86-1.02R(4)(c) Visors and Directional Louvers

The visor must be a tunnel type.

The visor must have a downward tilt from 3 to 7 degrees with a minimum length of 9-1/2 inches for nominal 12-inch round lenses and 7 inches for nominal 8-inch round lenses.

A metal visor must be formed from minimum 0.050-inch-thick aluminum alloy sheet.

A plastic visor must be either formed from sheet plastic or blow-molded. The plastic must be a black homogeneous color with a lusterless finish. A visor must withstand a wind load applied to its side for 24

hours without permanent deformation or removal from its door when tested under California Test 605 for plastic visors and California Test 666 for metal visors.

If directional louvers are used, the louvers must fit into full-circular signal visors. Louvers must consist of one of the following:

1. Outside cylinder constructed of sheet steel with a minimum nominal thickness of 0.030 inch and vanes constructed of sheet steel with a minimum nominal thickness of 0.016 inch.
2. Outside cylinder and vanes constructed of 5052-H32 aluminum alloy of equal thickness.

86-1.02S Pedestrian Signal Heads

86-1.02S(1) General

A pedestrian signal head consists of a pedestrian signal mounting assembly and a pedestrian signal face comprising of a pedestrian signal housing, an LED countdown pedestrian signal face module, and a front screen.

86-1.02S(2) Pedestrian Signal Mounting Assemblies

A pedestrian signal mounting assembly must comply with the specifications for a signal mounting assembly in section 86-1.02R, except mast arm slip fitters are not required.

86-1.02S(3) Pedestrian Signal Faces

86-1.02S(3)(a) General

Each pedestrian signal face must include a light-duty terminal block rated at 5 A and have 12 positions with no. 6-by-1/8-inch binder head screws. Each position must have 1 screw-type terminal.

The wiring and terminal block must comply with ITE publication ST-055-E, *Pedestrian Traffic Control Signal Indicators: Light Emitting Diode (LED) Signal Modules*.

86-1.02S(3)(b) Pedestrian Signal Housings

Pedestrian signal housing must comply with the specifications for a signal housing in 86-1.02R(4)(a)(iii), except the maximum overall dimensions must be 18-1/2 inches wide, 19 inches high, and 11-1/2 inches deep and without:

1. Visor
2. Watertight module or lens mounted in the door
3. Reinforcement plates

The housing must have a terminal block attached to the back. The terminal block must have enough positions to accommodate all indications. Each position must be permanently labeled for the indications used.

86-1.02S(3)(c) LED Countdown Pedestrian Signal Face Modules

An LED countdown PSF module must comply with ITE publication ST-055-E, *Pedestrian Traffic Control Signal Indicators: Light Emitting Diode (LED) Signal Modules*, except the material must comply with ASTM D3935 and the module must have:

1. Ultra-bright-type LED rated for 100,000 hours of continuous operation.
2. Lot number and month and year of manufacture permanently marked on the back of the module
3. Prominent and permanent vertical markings for accurate indexing and orientation within the pedestrian signal housing if a specific mounting orientation is required. Markings must be a minimum of 1 inch in height and include an up arrow and the word *up* or *top*.
4. Circuit board complying with TEES, chapter 1, section 6.

Individual LEDs must be wired such that a loss or failure of 1 LED will not result in a loss of more than 5 percent of the module's light output. Failure of an individual LED in a string must not result in a loss of an entire string or other indication.

Each symbol must be at least 9 inches high and 5-1/4 inches wide. The 2-digit countdown timer, *Upraised Hand*, and *Walking Person* indications must be electronically isolated from each other. The 3 indications must not share a power supply or interconnect circuitry.

The module must operate over the specified ambient temperature and voltage range and be readable both day and night at distances up to the full width of the area to be crossed. Upon initial testing at 25 degrees C, the module must have at least the luminance values shown in the following table:

PSF module symbol	Luminance
Upraised hand and 2-digit countdown timer (fL)	1,094
Walking person (fL)	1,547

The module must not exceed the power consumption requirements shown in the following table:

PSF module display	At 24 °C	At 74 °C
<i>Upraised Hand</i>	10.0 W	12.0 W
<i>Walking Person</i>	9.0 W	12.0 W
2-digit countdown timer	6.0 W	8.0 W

86-1.02S(3)(d) Front Screen

Pedestrian signal face must have a front screen that is one of the following types:

1. 3/8-inch-thick aluminum honeycomb screen with 0.2-inch-wide cells or a 1/2-inch-thick plastic screen with 3/8-inch-wide squares with 1/16-inch wall thickness that:
 - 1.1. Is installed so it tilts downward at an angle of 15 ± 2 degrees from the top and completely covers the message plate.
 - 1.2. Includes a clear front cover made of either a minimum 1/8-inch-thick acrylic plastic sheet or a minimum 1/16-inch-thick polycarbonate plastic.
 - 1.3. Is held firmly in place, including the cover, with stainless steel or aluminum clips or stainless steel metal screws.
2. Polycarbonate screen that:
 - 2.1. Has a nominal thickness of 1/32 inch.
 - 2.2. Is a 1-1/2-inch-deep eggcrate or Z-crate type.
 - 2.3. Is mounted in a frame constructed of aluminum alloy or polycarbonate with a minimum thickness of 0.040 inch.
 - 2.4. Is held in place with stainless steel screws.

The screen and frame of a pedestrian signal face must be made of either (1) plastic that is a flat black color or (2) anodized aluminum that is a flat black color or finished with lusterless, black, exterior-grade latex paint formulated for application to metal surfaces.

86-1.02T Accessible Pedestrian Signals

Accessible pedestrian signal must comply with the *California MUTCD*, chapter 4E, and have:

1. Audible speech message that plays when the push button is actuated. The message must include the name of the street to be crossed. The accessible pedestrian signal must have at least 5 audible message options.
2. Push button locator tone that clicks or beeps.
3. Feature that activates the pedestrian phase during a failure of the audible message, locator tone, or vibrotactile device.

An accessible pedestrian signal must function with the Department-furnished Model 170E/2070E controller assembly.

No part of the accessible pedestrian signal must be installed inside the controller cabinet. Power for the accessible pedestrian signal must be from the pedestrian signal housing terminal block.

The housing for the signal assembly must be made of corrosion-resistant material. Theft-proof bolts used for mounting the housing to the standard must be stainless steel with a content of 17 percent chromium and 8 percent nickel. The housing must be shaped to fit the pole's curvature.

The color of a metallic housing must match color no. 33538 of FED-STD-595.

The color of a plastic housing must match color no. 17038, 27038, or 37038 of FED-STD-595.

Accessible pedestrian signal must:

1. Have electronic switches, a potentiometer, or an access port for a device for controlling and programming the volume level and messaging
2. Be weatherproof and shockproof

Enclosure for the accessible pedestrian signal must:

1. Weigh less than 7 lb
2. Measure less than 16 by 6 by 5 inches
3. Have a wiring hole with a diameter not exceeding 1-1/8 inches
5. Have a switch for a push button
6. Have a vibrotactile device on the push button or on the arrow
7. Have an internal weatherproof speaker and microphone that senses the ambient sound level

The separation between adjacent holes used for conductors and mounting must be at least twice the diameter of the larger hole.

The speaker grills must be located on the surface of the enclosure. The speakers must not interfere with the housing or its mounting hardware.

The conductor cable between the accessible pedestrian signal assembly and the pedestrian signal head must be a 9 no. 20 conductor cable complying with MIL-W-16878D.

86-1.02U Push Button Assemblies

The housing for a push button assembly must be made of die-cast aluminum, permanent mold-cast aluminum, or UV-stabilized self-extinguishing structural plastic. The plastic housing must have a color throughout that matches color no. 17038, 27038, or 37038 of FED-STD-595.

If the push button is to be attached to a pole, the housing must be shaped to fit the pole's curvature.

The assembly must be waterproof and shockproof.

The push button's switch must be a single-pole, double-throw switching unit with screw-type terminals rated 15 A at 125 V(ac).

Switch for the push button must have:

1. Plunger actuator and a U frame to allow recessed mounting in the push button housing
2. Operating force of 3.5 lb
3. Maximum pretravel of 5/64 inch
4. Minimum overtravel of 1/32 inch
5. Differential travel from 0.002 to 0.04 inch
6. Minimum 2-inch diameter actuator

86-1.02V Reserved

86-1.02W Loop Detector Sealants

86-1.02W(1) General

Sealant for filling loop detector slots must be one of the following:

1. Asphaltic emulsion
2. Elastomeric sealant
3. Epoxy sealant for inductive loops
4. Hot-melt rubberized asphalt

86-1.02W(2) Asphaltic Emulsion Sealant

Asphaltic emulsion sealant must comply with the State Specification 8040-41A-15.

86-1.02W(3) Elastomeric Sealant

Elastomeric sealant must be a polyurethane material that cures only in the presence of moisture if used within the stated shelf life. The sealant must be suitable for use in both asphalt concrete and concrete pavement.

The cured elastomeric sealant must comply with the requirements shown in the following table:

Cured Elastomeric Sealant Requirements

Quality characteristic	Test method	Requirement
Hardness	ASTM D2240 ^a	65–85
Tensile strength (min, MPa)	ASTM D412 ^b	3.45
Elongation (min, %)		400
Flex at -40 °C ^c	--	No cracks
Weathering resistance	ASTM D822 ^d	Slight chalking
Salt spray resistance:	ASTM B117 ^e	
Tensile strength (min, MPa)		3.45
Elongation (min, %)		400
Dielectric constant (%)	ASTM D150 ^f	<25

^aIndentation at 25 °C and 50% relative humidity (Rex. Type A, Model 1700 only)

^bDie C pulled at 508 mm/minute

^c0.6-mm free film bend (180°) over 13-mm mandrel

^dWeatherometer 350 h, cured 7 days at 25 °C and 50% relative humidity

^e28 days at 38 °C with 5% NaCl, Die C, and pulled at 508 mm/minute)

^fChange over a temperature range from -30 to 50 °C

86-1.02W(4) Hot-Melt Rubberized Asphalt Sealant

Hot-melt rubberized asphalt sealant must:

1. Be in solid form at room temperature and fluid at an application temperature range from 190 to 205 degrees C
2. Not produce toxic fumes
3. Be suitable for use in both asphalt concrete and concrete pavement
4. Be packaged in containers clearly marked *Detector Loop Sealant* with the manufacturer's batch and lot number.

The cured hot-melt rubberized asphalt sealant must comply with the requirements shown in the following table:

Cured Hot-Melt Rubberized Asphalt Sealant Requirements

Quality characteristic	Test method	Requirement
Cone penetration (max, 1/10 mm)	ASTM D5329, sec. 6 ^a	35
Flow (max, mm)	ASTM D5329, sec. 8 ^b	5
Resilience (min, %)	ASTM D5329, sec. 12 ^c	25
Softening point (min, °C)	ASTM D36	82
Ductility (min, cm)	ASTM D113 ^d	30
Flash point, Cleveland Open Cup (min, °C)	ASTM D92	288
Viscosity (Pa·s)	ASTM D4402 ^e	2.5–3.5

^aAt 25 °C, 150 g, 5 s

^bAt 60 °C

^cAt 25 °C

^dAt 25 °C, 5 cm/minute

^eBrookfield Thermosel, no. 27 spindle, 20 rpm, 190 °C

86-1.02X Reserved

86-1.02Y Transformers

A transformer must be single-phase and may be a nonsubmersible or submersible type.

A transformer must be a dry type designed for operation on a 60 Hz supply. The transformer must have a decal showing a connection diagram. The diagram must show either color coding or wire tagging with primary (H1, H2) or secondary (X1, X2) markers and the primary and secondary voltage and volt-ampere rating. A transformer must comply with the electrical requirements shown in the following table:

Transformer Electrical Requirements

Quality characteristic	Requirement
Rating (V(ac))	120/480, 120/240, 240/480, or 480/120
Efficiency (%)	> 95
Secondary voltage regulation and tolerance from half load to full load (%)	±3

Secondary 240 and 480 V(ac) windings must be center tapped.

The transformer must withstand the application of 2,200 V(ac) from core to coils and from coil to coil for a 1-minute period when tested immediately after operation of the transformer at full load for 24 hours.

The external leads for the secondary connections must be no. 10 Type USE rated for 600 V(ac).

The transformer's leads must extend a minimum of 12 inches from the case.

The transformer's insulation must be NEMA 185 C or better.

Each transformer must:

1. Include metal half-shell coil protection.
2. Have moisture-resistant, synthetic-varnish-impregnated windings.
3. Be waterproof and suitable for outdoor operation.

Each submersible transformer must:

1. Include a handle and a hanger.
2. Be securely encased in a rugged, corrosion-resistant, watertight case.
3. Have leads that extend out through 1 or more sealed hubs.
4. Be manufactured to withstand a 5-day test with 12-hour on and off periods submerged in 2 feet of salt water that is 2 percent salt by weight. The operating periods must be at full load.

86-1.02Z Batteries

Battery must:

1. Be deep-cycle, sealed, prismatic, lead-calcium-based, absorbed-glass-mat, valve-regulated, lead-acid type
2. Be rated for 12 V
3. Be rated for a temperature range from -25 to 60 degrees C
4. Be group size 24
5. Be commercially available and stocked locally
6. Be marked with a date code, maximum recharge data, and recharge cycles
7. Be new and fully charged when furnished
8. Be free from damage or deformities
9. Have a carrying handle
10. Have 2 top-mounted, threaded-stud posts that include all washers and nuts
11. Include insulating rubber covers for protecting the lugs, posts, and wiring: red for the positive terminal and black for the negative terminal

If a battery is used for a battery backup system, it must accommodate 3/8-inch ring lugs of a Department-furnished battery harness.

86-1.03 CONSTRUCTION

Not Used

86-1.04 PAYMENT

Not Used

Replace section 87 with:

04-15-16

87 ELECTRICAL SYSTEMS

04-15-16

87-1 GENERAL

87-1.01 GENERAL

87-1.01A Summary

Section 87 includes general specifications for constructing and installing electrical systems.

The Department deducts the cost for maintenance performed by the Department on new or portions of existing systems modified under the Contract.

87-1.01B Definitions

Reserved

87-1.01C Submittals

Reserved

87-1.01D Quality Assurance

87-1.01D(1) General

Reserved

87-1.01D(2) Quality Control

Before shipping the material to the job site, submit to METS test samples of:

1. Accessible pedestrian signals
2. LED countdown pedestrian signal face modules
3. LED signal modules
4. LED luminaires

Submit a sample size as shown in the following table:

Electrical Material Sampling

Contract quantity	Test sample size
1–8	1
9–15	2
16–25	3
26–90	5
91–150	8
151–280	13
281–500	20
501–1200	32

Before starting operation of an electrical system, perform a conductor test in the presence of the Engineer.

Conductor test consists of testing each conductor and the conductors in cables for:

1. Continuity.
2. Grounds.
3. Insulation resistance at 500 V(dc) between the circuit and ground. The insulation resistance must be a minimum of 10 MΩ on circuits, except it must be a minimum of 100 MΩ for inductive loop detector circuits.

Start the operational test of the system on any day except Friday or the day before a holiday. The operational test for signals must start from 9:00 a.m. to 2:00 p.m. Notify the Engineer 48 hours before starting the test.

An operational test consists of a minimum of 5 business days of continuous, satisfactory operation of the system. If the system fails, correct the problem and retest the system. A shutdown of the system caused by traffic, a power interruption, or unsatisfactory performance of Department-furnished materials does not constitute discontinuity of the test.

87-1.02 MATERIALS

Not Used

87-1.03 CONSTRUCTION

87-1.03A General

The Engineer determines the final locations of electrical systems.

Verify the locations of electrical systems and the depths of existing detectors, conduits, and pull boxes.

Notify the Engineer before performing work on the existing system.

You may shut down the system for alteration or removal.

Where an existing Department underground facility is shown within 10 feet of any excavation, locate and field mark the facility before performing work that could damage or interfere with the existing facility.

If an existing facility is within 2 feet of an excavation, determine the exact location of the facility by excavating with hand tools before using any power-operated or power-driven excavating or boring equipment. A vacuum excavator may be used if authorized.

Notify the Engineer immediately if an existing facility is damaged by your activities.

If existing underground conduit is to be incorporated into a new system, clean it with a mandrel or cylindrical wire brush and blow it clean with compressed air.

Limit the shutdown of traffic signal systems to normal working hours. Notify the local traffic enforcement agency before shutting down the signal.

Place temporary W3-1 and R1-1 signs in each direction to direct traffic through the intersection during shutdown of the signal. Place two R1-1 signs for 2-lane approaches. The signs must comply with part 2 of the *California MUTCD*.

Cover signal faces when the system is shut down overnight. Cover temporary W3-1 and R1-1 signs when the system is turned on.

If you work on an existing lighting system and the roadway is to remain open to traffic, ensure the system is in operation by nightfall.

Replace detectors you damage within 72 hours, or the Department replaces them and deducts the cost.

Work performed on an existing system not described is change order work.

Do not use electrical power from existing highway facilities unless authorized.

Maintain a minimum 48-inch clearance for a pedestrian pathway when placing equipment.

Except for service installation or work on service equipment enclosures, do not work above ground until all materials are on hand to complete the electrical work at each location.

Bond all metal components to form a continuous grounded system as specified in NEC.

Ground metallic equipment mounted less than 8 feet above the ground surface on a wood pole.

If you damage any portion of a concrete curb, sidewalk, curb ramp, driveway, or gutter depression, replace the entire section between contraction or expansion joints under section 73.

Apply equipment identification characters.

Orient louvers, visors, and signal faces such that they are clearly visible to approaching traffic from the direction being controlled.

Test loops and the detector lead-in cable circuit for continuity, ground, and insulation resistance at the controller cabinet before connecting detector lead-in cable to the terminal block.

Perform an operational test of the systems.

Before starting the operational test for systems that impact traffic, the system must be ready for operation, and all signs, pavement delineation, and pavement markings must be in place at that location.

87-1.03B Conduit Installation

87-1.03B(1) General

The installation of conduit includes installing caps, bushings, and pull tape and terminating the conduit in pull boxes, foundations, poles, or a structure.

Limit the number of bends in a conduit run to no more than 360 degrees between pull points.

Use conduit to enclose conductors except where they are installed overhead or inside standards or posts.

You may use a larger size conduit than specified for the entire length between termination points. Do not use a reducing coupling.

Extend an existing conduit using the same material. Terminate conduits of different materials in a pull box.

Install 2 conduits between a controller cabinet and the adjacent pull box.

Use a minimum trade size of conduit of:

1. 1-1/2 inches from an electrolier to the adjacent pull box
2. 1 inch from a pedestrian push button post to the adjacent pull box
3. 2 inches from a signal standard to the adjacent pull box
4. 3 inches from a controller cabinet to the adjacent pull box
5. 2 inches from an overhead sign to the adjacent pull box
6. 2 inches from a service equipment enclosure to the adjacent pull box
7. 1-1/2 inches if unspecified

Use Type 1 conduit:

1. On all exposed surfaces
2. In concrete structures
3. Between a structure and the nearest pull box

Ream the ends of shop-cut and field-cut conduit to remove burrs and rough edges. Make the cuts square and true. Do not use slip joints and running threads to couple conduit. If a standard coupling cannot be used for metal-type conduit, use a threaded union coupling. Tighten the couplings for metal conduit to maintain a good electrical connection.

Cap the ends of conduit to prevent debris from entering before installing the conductors or cables. Use a plastic cap for Type 1, 2, and 5 conduits and a standard pipe cap for all other types of conduit.

For Type 1, 2, and 5 conduits, use threaded bushings and bond them using a jumper. For other types of conduit, use nonmetallic bushings.

Do not install new conduit through foundations.

Cut Type 2 conduit with pipe cutters; do not use hacksaws. Use standard conduit-threading dies for threading conduit. Tighten conduit into couplings or fittings using strap wrenches or approved groove joint pliers.

Cut Type 3 conduit with tools that do not deform the conduit. Use a solvent weld for connections.

Protect shop-cut threads from corrosion under the standards shown in the following table:

Conduit	Standard
Types 1 and 2	ANSI C80.1
Type 5	ANSI C80.6

Apply 2 coats of unthinned, organic zinc-rich primer to metal conduit before painting. Use a primer on the Authorized Material List for organic zinc-rich primers. Do not use aerosol cans. Do not remove shop-installed conduit couplings.

For conduits, paint:

1. All exposed threads
2. Field-cut threads, before installing conduit couplings to metal conduit
3. Damaged surfaces on metal conduit

If a Type 2 conduit or conduit coupling coating is damaged:

1. Clean the conduit or fitting and paint it with 1 coat of rubber-resin-based adhesive under the manufacturer's instructions
2. Wrap the damaged coating with at least 1 layer of 2-inch-wide, 20 mils-minimum-thickness, PVC tape under ASTM D1000 with a minimum tape overlap of 1/2 inch

You may repair damaged spots of 1/4 inch or less in diameter in the thermoplastic coating by painting with a brushing-type compound supplied by the conduit manufacturer.

If factory bends are not used, bend the conduit to a radius no less than 6 times its inside diameter without crimping or flattening it. Comply with the bending requirements shown in the following table:

Type	Requirement
1	Use equipment and methods under the conduit manufacturer's instructions.
2	Use a standard bending tool designed for use on thermoplastic-coated conduit. The conduit must be free of burrs and pits.
3	Use equipment and methods under the conduit manufacturer's instructions. Do not expose the conduit to a direct flame.
5	Use equipment and methods under the conduit manufacturer's instructions.

Install pull tape with at least 2 feet of slack in each end of the conduit that will remain empty. Attach the tape's ends to the conduit.

Install conduit terminating in a standard or pedestal from 2 to 3 inches above the foundation. Slope the conduit toward the handhole opening.

Terminate conduit installed through the bottom of a nonmetallic pull box 2 inches above the bottom and 2 inches from the wall closest to the direction of the run.

87-1.03B(2) Conduit Installation for Structures

87-1.03B(2)(a) General

Paint exposed Type 1 conduit the same color as the structure.

Install galvanized steel hangers, steel brackets, and other fittings to support conduit in or on a wall or bridge.

87-1.03B(2)(b) New Structures

Seal and make watertight the conduits which lead to soffits, wall-mounted luminaires, other lights, and fixtures located below the pull box grade.

If you place a conduit through the side of a nonmetallic pull box, terminate the conduit 2 inches from the wall and 2 inches above the bottom. Slope the conduit toward the top of the box to facilitate pulling conductors.

For ease of installation and if authorized, you may use Type 4 conduit instead of Type 1 conduit for the final 2 feet of conduit entering a pull box in a reinforced concrete structure.

Install an expansion fitting where a conduit crosses an expansion joint in a structure. Each expansion fitting for metal conduit must include a copper bonding jumper having the ampacity as specified in NEC.

Install an expansion-deflection fitting for an expansion joint with a 1-1/2-inch movement rating. The fitting must be watertight and include a molded neoprene sleeve, a bonding jumper, and 2 silicon bronze or zinc-plated iron hubs.

For an expansion joint with a movement rating greater than 1-1/2 inches, install the expansion-deflection fitting as shown.

For conduit installed inside of bridge structures, you must:

1. Install precast concrete cradles made of minor concrete and commercial-quality welded wire fabric. The minor concrete must contain a minimum of 590 lb of cementitious material per cubic yard. The cradles must be moist cured for a minimum of 3 days.
2. Bond precast concrete cradles to a wall or bridge superstructure with one of the following:
 - 2.1. Epoxy adhesive for bonding freshly-mixed concrete to hardened concrete.
 - 2.2. Rapid-set epoxy adhesive for pavement markers.
 - 2.3. Standard-set epoxy adhesive for pavement markers.
3. Use a pipe sleeve or form an opening for a conduit through a bridge superstructure. The sleeve or opening through a prestressed member or conventionally reinforced precast member must be:
 - 3.1. Oriented transverse to the member.
 - 3.2. Located through the web.
 - 3.3. No more than 4 inches in size.
4. Wrap the conduit with 2 layers of asphalt felt building paper and securely tape or wire the paper in place for a conduit passing through a bridge abutment wall. Fill the space around the conduit with mortar under section 51-1, except the proportion of cementitious material to sand must be 1 to 3. Fill the space around the conduits after prestressing is completed.

Thread and cap a conduit installed for future use in structures. Mark the location of the conduit's end in a structure, curb, or wall directly above the conduit with a Y that is 3 inches tall.

87-1.03B(2)(c) Existing Structures

Run surface-mounted conduit straight and true, horizontal or vertical on the wall, and parallel to walls on ceilings or similar surfaces. Support the conduit at a maximum of 5-foot intervals where needed to prevent vibration or deflection. Support the conduit using galvanized, malleable-iron, conduit clamps, and clamp backs secured with expansion anchorage devices complying with section 75-3.02C. Use the largest diameter of galvanized, threaded studs that will pass through the mounting hole in the conduit clamp.

87-1.03B(3) Conduit Installation Underground

87-1.03B(3)(a) General

Install conduit to a depth of:

1. 14 inches for the trench-in-pavement method
2. 18 inches, minimum, under sidewalk and curbed paved median areas
3. 42 inches, minimum, below the bottom of the rail of railroad tracks

4. 30 inches, minimum, everywhere else below grade

Place conduit couplings at a minimum of 6 inches from the face of a foundation.

Place a minimum of 2 inches of sand bedding in a trench before installing Type 2 or Type 3 conduit and 4 inches of sand bedding over the conduit before placing additional backfill material.

If installing conduit within the limits of hazardous locations as specified in NEC for Class I, division 1, install and seal Type 1 or Type 2 conduit with explosion-proof sealing fittings.

87-1.03B(3)(b) Conduit Installation under Paved Surfaces

You may lay conduit on existing pavement within a new curbed median constructed on top.

Install conduit under existing pavement by the jacking or drilling methods. You may use the trench-in-pavement method for either of the following conditions:

1. If conduit is to be installed behind the curb under the sidewalk
2. If the delay to vehicles will be less than 5 minutes

Do not use the trench-in-pavement method for conduit installations under freeway lanes or freeway-to-freeway connector ramps.

87-1.03B(3)(c) Reserved

87-1.03B(3)(d) Conduit Installation under Railroad Tracks

Install Type 1 or Type 2 conduit with a minimum diameter of 1-1/2 inches under railroad tracks. If you use the jacking or drilling method to install the conduit, construct the jacking pit a minimum of 13 feet from the tracks' centerline at the near side of the pit. Cover the jacking pit with planking if left overnight.

87-1.03B(4) Reserved

87-1.03B(5) Conduit Installation by the Jacking or Drilling Method

Keep the jacking or drilling pit 2 feet away from the pavement's edge. Do not weaken the pavement or soften the subgrade with excessive use of water.

If an obstruction is encountered, obtain authorization to cut small holes in the pavement to locate or remove the obstruction.

You may install Type 2 or Type 3 conduit under the pavement if a hole larger than the conduit's diameter is predrilled. The predrilled hole must be less than one and half the conduit's diameter.

Remove the conduit used for drilling or jacking and install new conduit for the completed work.

87-1.03B(6) Conduit Installation by the Trenching-In-Pavement Method

Install conduit by the trenching-in-pavement method using a trench approximately 2 inches wider than the conduit's outside diameter but not exceeding 6 inches in width.

Where additional pavement is to be placed, you must complete the trenching before the final pavement layer is applied.

If the conduit shown is to be installed under the sidewalk, you may install it in the street within 3 feet of and parallel to the face of the curb. Install pull boxes behind the curb.

Cut the trench using a rock-cutting excavator. Minimize the shatter outside the removal area of the trench.

Dig the trench by hand to the required depth at pull boxes.

Place conduit in the trench.

Backfill the trench with minor concrete to the pavement's surface by the end of each work day. If the trench is in asphalt concrete pavement and no additional pavement is to be placed, backfill the top 0.10 foot of the trench with minor HMA within 3 days after trenching.

87-1.03C Installation of Pull Boxes

87-1.03C(1) General

Install pull boxes no more than 200 feet apart.

You may install larger pull boxes than specified or shown and additional pull boxes to facilitate the work except in structures.

Install a pull box on a bed of crushed rock and grout it before installing conductors. The grout must be from 0.5 to 1 inch thick and sloped toward the drain hole. Place a layer of roofing paper between the grout and the crushed rock sump. Make a 1-inch drain hole through the grout at the center of the pull box.

Set the pull box such that the top is 1-1/4 inches above the surrounding grade in unpaved areas and leveled with the finished grade in sidewalks and other paved areas.

Place the cover on the box when not working in it.

Grout around conduits that are installed through the sides of the pull box.

Bond and ground the metallic conduit before installing conductors and cables in the conduit.

Bond metallic conduits in a nonmetallic pull box using bonding bushings and bonding jumpers.

Do not install pull boxes in concrete pads, curb ramps, or driveways.

Reconstruct the sump of a pull box if disturbed by your activities. If the sump was grouted, remove and replace the grout.

87-1.03C(2) Nontraffic Pull Boxes

If you bury a nontraffic pull box, set the box such that the top is 6 to 8 inches below the surrounding grade. Place a 20-mil-thick plastic sheet made of HDPE or PVC virgin compounds to prevent water from entering the box.

Place mortar between a nontraffic pull box and a pull box extension.

Where a nontraffic pull box is in the vicinity of curb in an unpaved area, place the box adjacent to the back of the curb if practical.

Where a nontraffic pull box is adjacent to a post or standard, place the box within 5 feet upstream from traffic if practical.

If you replace the cover on a nontraffic pull box, anchor it to the box.

87-1.03C(3) Traffic Pull Boxes

Place minor concrete around and under a traffic pull box.

Bolt the steel cover to the box when not working in it.

Bond the steel cover to the conduit with a jumper and bolt it down after installing the conductors and cables.

87-1.03C(4) Structure Pull Boxes

Bond metallic conduit in a metal pull box in a structure using locknuts, inside and outside of the box, bonding bushings, and bonding jumpers connected to bonding wire running in the conduit system.

87-1.03D Reserved

87-1.03E Excavating and Backfilling for Electrical Systems

87-1.03E(1) General

Notify the Engineer at least 72 hours before starting excavation activities.

Dispose of surplus excavated material.

Restrict closures for excavation on a street or highway to 1 lane at a time unless otherwise specified.

87-1.03E(2) Trenching

Dig a trench for the electrical conduits or direct burial cables. Do not excavate until the conduit or direct burial cable will be installed.

Place excavated material in a location that will not interfere with traffic or surface drainage.

After placing the conduit or direct burial cable, backfill the trench with the excavated material. Compact the backfill placed outside the hinge point of slopes and not under pavement to a minimum relative compaction of 90 percent.

Compact the backfill placed within the hinge points and in areas where pavement is to be constructed to a minimum relative compaction of 95 percent.

Restore the sidewalks, pavement, and landscaping at a location before starting excavation at another location.

87-1.03E(3) Concrete Pads, Foundations, and Pedestals

Construct foundations for standards, poles, metal pedestals, and posts under section 56-3.

Construct concrete pads, foundations, and pedestals for controller cabinets, telephone demarcation cabinets, and service equipment enclosures on firm ground.

Install anchor bolts using a template to provide proper spacing and alignment. Moisten the forms and ground before placing the concrete. Keep the forms in place until the concrete sets for at least 24 hours to prevent damage to the surface.

Use minor concrete for pads, foundations, and pedestals.

In unpaved areas, place the top of the foundation 6 inches above the surrounding grade, except place the top:

1. 1 foot 6 inches above the grade for Type M and 336L cabinets
2. 1 foot 8 inches above the grade for Type C telephone demarcation cabinets
3. 2 inches above the grade for Type G and Type A cabinets and Type III service equipment enclosures

The pad must be 2 inches above the surrounding grade.

In and adjacent to the sidewalk and other paved areas, place the top of the foundation 4 inches above the surrounding grade, except place the top:

1. 1 foot 6 inches above the grade for Type M and 336L cabinets
2. 1 foot 8 inches above the grade for Type C telephone demarcation cabinets
3. Level with the finished grade for Type G and Type A cabinets and Type III service equipment enclosures

The pad must be level with the finished grade.

Apply an ordinary surface finish under section 51-1.03F.

Allow the foundation to cure for at least 7 days before installing any equipment.

87-1.03F Conductors and Cable Installations

87-1.03F(1) General

The installation of conductors and cables includes splicing conductors and attaching the terminals and connectors to the conductors.

Clean the conduit and pull all conductors and cables as a unit.

If new conductors or cables are to be added in an existing conduit:

1. Remove the content
2. Clean the conduit
3. Pull both old and new conductors and cables as a unit

Wrap conductors and secure cables to the end of the conduit in a pull box.

Seal the ends of conduits with a sealing compound after installing conductors or cables.

Neatly arrange conductors and cables inside pull boxes and cabinets. Tie the conductors and cables together with self-clinching nylon cable ties or enclose them in a plastic tubing or raceway.

Identify conductors and cables by direct labeling, tags, or bands fastened in such a way that they will not move. Use mechanical methods for labeling.

Provide band symbol identification on each conductor or each group of conductors comprising a signal phase in each pull box and near the end of terminated conductors.

Tape the ends of unused conductors and cables in pull boxes to form a watertight seal.

Do not connect the push-button or accessible pedestrian signal neutral conductor to the signal neutral conductor.

87-1.03F(2) Cables

87-1.03F(2)(a) General

Reserved

87-1.03F(2)(b) Reserved

87-1.03F(2)(c) Copper Cables

87-1.03F(2)(c)(i) General

Reserved

87-1.03F(2)(c)(ii) Detector Lead-in Cables

Install a Type B or C detector lead-in cable in conduit.

Waterproof the ends of the lead-in cable before installing it in the conduit to prevent moisture from entering the cable.

Splice loop conductors for each direction of travel for the same phase, terminating in the same pull box, to a separate lead-in cable running from the pull box adjacent to the loop detector to a sensor unit mounted in the controller cabinet. Install the lead-in cable without splices except at the pull box.

Verify in the presence of the Engineer that the loops are operational before making the final splices between loop conductors and the lead-in cable.

Identify and tag each lead-in cable with the detector designation at the cabinet and pull box adjacent to the loops.

87-1.03F(2)(c)(iii) Conductors Signal Cables

Do not splice signal cables except for a 28-conductor cable.

Provide identification at the ends of terminated conductors in a cable as shown.

Provide identification for each cable in each pull box showing the signal standard to which it is connected except for the 28-conductor cable.

Connect conductors in a 12-conductor cable as shown in the following table:

12CSC Color Code and Functional Connection

Color code	Termination	Phase
Red	Red signal	2, 4, 6, or 8
Yellow	Yellow signal	2, 4, 6, or 8
Brown	Green signal	2, 4, 6, or 8
Red/black stripe	Red signal	1, 3, 5, or 7
Yellow/black stripe	Yellow signal	1, 3, 5, or 7
Brown/black stripe	Green signal	1, 3, 5, or 7
Black/red stripe	Spare or as required for red or <i>DONT WALK</i>	--
Black/white stripe	Spare or as required for yellow	--
Black	Spare or as required for green or <i>WALK</i>	--
Red/white stripe	Pedestrian signal <i>DONT WALK</i>	--
Brown/white stripe	Pedestrian signal <i>WALK</i>	--
White	Terminal block	Neutral

Provide identification for each 28-conductor cable C1 or C2 in each pull box. The cable labeled C1 must be used for signal phases 1, 2, 3, and 4. The cable labeled C2 must be used for signal phases 5, 6, 7, and 8.

Connect conductors in a 28-conductor cable as shown in the following table:

28CSC Color Code and Functional Connection

Color code	Termination	Phase
Red/black stripe	Red signal	2 or 6
Yellow/black stripe	Yellow signal	2 or 6
Brown/black stripe	Green signal	2 or 6
Red/orange stripe	Red signal	4 or 8
Yellow/orange stripe	Yellow signal	4 or 8
Brown/orange stripe	Green signal	4 or 8
Red/silver stripe	Red signal	1 or 5
Yellow/silver stripe	Yellow signal	1 or 5
Brown/silver stripe	Green signal	1 or 5
Red/purple stripe	Red signal	3 or 7
Yellow/purple stripe	Yellow signal	3 or 7
Brown/purple stripe	Green signal	3 or 7
Red/2 black stripes	Pedestrian signal <i>DONT WALK</i>	2 or 6
Brown/2 black stripes	Pedestrian signal <i>WALK</i>	2 or 6
Red/2 orange stripes	Pedestrian signal <i>DONT WALK</i>	4 or 8
Brown/2 orange stripes	Pedestrian signal <i>WALK</i>	4 or 8
Red/2 silver stripes	Overlap A, C	OLA ^a , OLC ^a
Brown/2 silver stripes	Overlap A, C	OLA ^c , OLC ^c
Red/2 purple stripes	Overlap B, D	OLB ^a , OLD ^a
Brown/2 purple stripes	Overlap B, D	OLB ^c , OLD ^c
Blue/black stripe	Pedestrian push button	2 or 6
Blue/orange stripe	Pedestrian push button	4 or 8
Blue/silver stripe	Overlap A, C	OLA ^b , OLC ^b
Blue/purple stripe	Overlap B, D	OLB ^b , OLD ^b
White/black stripe	Pedestrian push button common	--
Black/red stripe	Railroad preemption	--
Black	Spare	--
White	Terminal block	Neutral

OL = Overlap; A, B, C, and D = Overlapping phase designation

^aFor red phase designation

^bFor yellow phase designation

^cFor green phase designation

Use the neutral conductor only with the phases associated with that cable. Do not intermix neutral conductors from different cables except at the signal controller.

87-1.03F(2)(c)(iv) Signal Interconnect Cable

For a signal interconnect cable, provide a minimum of 6 feet of slack inside each controller cabinet.

Do not splice the cable unless authorized.

If splices are authorized, insulate the conductor splices with heat-shrink tubing and overlap the insulation at least 0.6 inch. Cover the splice area of the cable with heat-shrink tubing and overlap the cable jacket at least 1-1/2 inches. Provide a minimum of 3 feet of slack at each splice.

87-1.03F(3) Conductors

87-1.03F(3)(a) General

Do not run conductors to a terminal block on a standard unless they are to be connected to a signal head mounted on that standard.

Provide 3 spare conductors in all conduits containing ramp metering and traffic signal conductors.

Install a separate conductor for each terminal of a push button assembly and accessible pedestrian signal.

Provide conductor slack to comply with the requirements shown in the following table:

Location	Slack (feet)
Signal standard	1
Lighting standard	1
Signal and lighting standard	1
Pull box	3
Splice	3
Standards with slip base	0

87-1.03F(3)(b) Reserved

87-1.03F(3)(c) Copper Conductors

87-1.03F(3)(c)(i) General

Install a minimum no. 8, insulated, grounding copper conductor in conduit and connect it to all-metal components.

Where conductors from different service points occupy the same conduit or standard, enclose the conductors from one of the services in flexible or rigid metal conduit.

87-1.03F(3)(c)(ii) Inductive Loop Conductors

Install a Type 1 or 2 inductive loop conductor except use Type 2 for Type E loop detectors.

Install the conductor without splices except at the pull box.

87-1.03F(4) Manual Installation Method

Use an inert lubricant for placing conductors and cables in conduit.

Pull the conductors and cables into the conduit by hand using pull tape.

87-1.03G Equipment Identification Characters

The Engineer provides you with a list of the equipment identification characters.

Stencil the characters or apply the reflective self-adhesive labels to a clean surface.

Treat the edges of self-adhesive characters with an edge sealant.

Place the characters on the side facing traffic on:

1. Front doors of cabinets and service equipment enclosures.
2. Wood poles, fastened with 1-1/4-inch aluminum nails, for pole mounted enclosures
3. Adjacent bent or abutment at approximately the same station as an illuminated sign or soffit luminaire
4. Underside of the structure adjacent to the illuminated sign or soffit luminaire if no bent or abutment exists nearby
5. Posts of overhead signs
6. Standards

Before placing new characters on existing or relocated equipment, remove the existing characters.

87-1.03H Conductor and Cables Splices

87-1.03H(1) General

You may splice:

1. Grounded conductors in a pull box
2. Accessible pedestrian signal and push bottom conductors in a pull box
3. Ungrounded signal conductors in a pull box if signals are modified

4. Ungrounded signal conductors to a terminal compartment or a signal head on a standard with conductors of the same phase in the pull box adjacent to the standard
5. Ungrounded lighting circuit conductors in a pull box if lighting circuits are modified

Solder all splices using the hot iron, pouring, or dipping method. Do not perform open-flame soldering.

87-1.03H(2) Splice Insulation Methods

Insulate splices in a multiconductor cable to form a watertight joint and to prevent moisture absorption by the cable.

Use heat-shrink tubing or Method B to insulate a splice.

Use heat-shrink tubing as follows:

1. Cover the splice area completely with an electrical insulating coating and allow it to dry.
2. Place mastic around each conductor before placing them inside the tubing. Use the type of mastic specified in the tubing manufacturer's instructions.
3. Heat the area under the manufacturer's instructions. Do not perform open-flame heating. After contraction, each end of the heat-shrink tubing or the open end of the tubing's end cap must overlap the conductor insulation at least 1-1/2 inches.
4. Cover the entire splice with an electrical insulating coating and allow it to dry.

Use Method B as follows:

1. Cover the splice area completely with an electrical insulating coating and allow it to dry.
2. Apply 3 layers of half-lapped, 80-mils, PVC tape.
3. Apply 2 layers of 120-mils, butyl-rubber, stretchable tape with liner.
4. Apply 3 layers of half-lapped, 6-mils, PVC, pressure-sensitive, adhesive tape.
5. Cover the entire splice with an electrical insulating coating and allow it to dry.

87-1.03I Connectors and Terminals

Apply connectors and terminals to cables and conductors using a crimping compression tool under the manufacturer's instructions. The tool must prevent opening of the handles until the crimp is completed.

Install crimp-style terminal lugs on stranded conductors smaller than no. 14.

Solder no. 8 and smaller conductors to connectors and terminal lugs.

87-1.03J Standards, Poles, Pedestals, and Posts

Install standards, poles, pedestals, and posts under section 56-3.

Ground standards with a handhole by attaching a bonding jumper from the bolt or lug inside the standard to a metal conduit or to the grounding wire in the adjacent pull box. The bonding jumper must be visible when the handhole cover is removed.

Ground standards without a handhole or standards with a slip base by attaching a bonding jumper to all anchor bolts using ground clamps and connecting it to a metal conduit or to the grounding wire in the adjacent pull box. The bonding jumper must be visible after mortar has been placed on the foundation.

87-1.03K Reserved

87-1.03L Utility Service

87-1.03L(1) General

Install the service equipment early enough to allow the utility to complete its work before completion of the electrical work.

At least 15 days before permanent electrical and telecommunication service is required, request the service connections for permanent installations. The Department arranges with the utilities for completion of the connections and pays all costs and fees required by the utilities.

87-1.03L(2) Electric Service

87-1.03L(2)(a) General

If service equipment is to be installed on a utility-owned pole, furnish and install the conduit, conductors, pull boxes, and other necessary material to complete the service installation. The service utility decides the position of the riser and equipment on the pole.

87-1.03L(2)(b) Electric Service for Irrigation

Establishing electric service for irrigation includes installing conduit, conductors, and pull boxes and making connections from the service point to the irrigation controllers.

87-1.03L(2)(c) Electric Service for Booster Pumps

Establishing electric service for a booster pump includes installing conduit, conductors, and pull boxes and making connections from the service point to the booster pump enclosure.

87-1.03L(3) Telecommunications Service

Establishing telecommunication service includes installing conduit, conductors, and pull boxes and making connections from the service point to the telephone demarcation cabinet.

87-1.03M Photoelectric Controls

Mount the photoelectric unit on the top of the pole for Type I, II, and III photoelectric controls. Use mounting brackets where pole-top mounting is not possible. Orient the photoelectric unit to face north.

Mount the enclosure at a height of 6 feet above finished grade on the same standard as the photoelectric unit.

Install a minimum 100 VA, 480/120 V(ac) transformer in the contactor enclosure to provide 120 V(ac) for the photoelectric control unit when switching 480 V(ac), 60 Hz circuits.

87-1.03N Fused Splice Connectors

Install a fuse splice connector in each ungrounded conductor for luminaires mounted on standards. The connector must be located in the pull box adjacent to the standard.

Crimp the connector terminals onto the ungrounded conductors using a tool under the manufacturer's instructions. Insulate the terminals and make them watertight.

87-1.03O Grounding Electrodes

Install a grounding electrode for each cabinet, service equipment enclosure, and transformer.

Attach a grounding conductor from the electrode using either a ground clamp or exothermic weld. Connect the other end of the conductor to the cabinet, service equipment enclosure, and transformer.

87-1.03P Service Equipment Enclosures

Installing a service equipment enclosure includes constructing the foundation and pad and installing conduit, adjacent pull boxes, and grounding electrode.

Locate the foundation such that the minimum clearance around the front and back of the enclosure complies with NEC, article 110.26, "Spaces About Electrical Equipment, (600 V, nominal or less)."

Bond and ground metal conduit as specified in NEC and by the service utility except the grounding electrode conductor must be no. 6 or larger.

If circuit breakers and components do not have a description on engraved phenolic nameplates, install them using stainless steel rivets or screws under section 86-1.02P(2).

87-1.03Q Cabinets

87-1.03Q(1) General

Installing a cabinet includes constructing the foundation and pad and installing conduit, adjacent pull boxes, and grounding electrode.

Apply a mastic or caulking compound before installing the cabinet on the foundation to seal the openings.

Connect the field wiring to the terminal blocks in the cabinet. Neatly arrange and lace or enclose the conductors in plastic tubing or raceway. Terminate the conductors with properly sized captive or spring spade terminals. Apply a crimp-style connector and solder them.

Install and solder a spade-type terminal on no. 12 and smaller field conductors and a spade-type or ring-type terminal on conductors larger than no. 12.

87-1.03Q(2) Department-Furnished Controller Cabinets

Arrange for the delivery of Department-furnished controller cabinets.

87-1.03Q(3) Reserved

87-1.03Q(4) Telephone Demarcation Cabinets

Installing a telephone demarcation cabinet includes installing conduit, cable, and pull boxes to the controller cabinet.

Install the cabinet with the back toward the nearest lane of traffic.

87-1.03R Signal Heads

87-1.03R(1) General

Installing a signal head includes mounting the heads on standards and mast arms, installing backplates and visors, and wiring conductors to the terminal blocks.

Keep the heads covered or direct them away from traffic until the system is ready for operation.

87-1.03R(2) Signal Faces

Use the same brand and material for the signal faces at each location.

Program the programmable visibility signal faces under the manufacturer's instructions. The indication must be visible only in those areas or lanes to be controlled.

87-1.03R(3) Backplates

Install backplates using at least six 10-24 or 10-32 self-tapping and locking stainless steel machine screws and flat washers.

If a plastic backplate requires field assembly, attach each joint using at least four no.10 machine screws. Each machine screw must have an integral or captive flat washer, a hexagonal head slotted for a standard screwdriver, and either a locking nut with an integral or captive flat washer or a nut, flat washer, and lock washer. Machine screws, nuts, and washers must be stainless steel or steel with a zinc or black oxide finish.

If a metal backplate has 2 or more sections, fasten the sections with rivets or aluminum bolts peened after assembly to avoid loosening.

Install the backplate such that the background light is not visible between the backplate and the signal face or between sections.

87-1.03R(4) Signal Mounting Assemblies

Install a signal mounting assembly such that its members are arranged symmetrically and plumb or level. Orient each mounting assembly to allow maximum horizontal clearance to the adjacent roadway.

For a bracket-mounted assembly, bolt the terminal compartment or pole plate to the pole or standard.

In addition to the terminal compartment mounting, attach the upper pipe fitting of Type SV-1-T with 5 sections or a SV-2-TD to the standard or pole using the mounting detail for signal heads without a terminal compartment.

Use a 4-1/2-inch slip fitter and set screws to mount an assembly on a post top.

After installing the assembly, clean and paint the exposed threads of the galvanized conduit brackets and bracket areas damaged by the wrench or vise jaws. Use a wire brush to clean and apply 2 coats of unthinned, organic zinc-rich primer. Do not use an aerosol can to apply the primer.

Install the conductors in the terminal compartment and secure the cover.

87-1.03S Pedestrian Signal Heads

Installing a pedestrian signal head includes mounting the heads on standards and wiring conductors to the terminal blocks.

Install the pedestrian signal mounting assembly under section 87-1.03R(4).

Use the same brand and material for the pedestrian signal faces at each location.

Install a pedestrian signal face such that its members are arranged symmetrically and plumb or level.

87-1.03T Accessible Pedestrian Signals

Use the same brand for the accessible pedestrian signals at each location.

Install an accessible pedestrian signal and the R10 series sign on the crosswalk side of the standard.

Attach the accessible pedestrian signal to the standard with self-tapping screws.

Attach the sign to the standard using 2 straps and saddle brackets.

Point the arrow on the accessible pedestrian signal in the same direction as the corresponding crosswalk.

Furnish the equipment and hardware to set up and calibrate the accessible pedestrian signal.

Arrange to have a manufacturer's representative at the job site to program the accessible pedestrian signal with an audible message or tone.

87-1.03U Push Button Assemblies

Install the push button assembly and the R10 series sign on the crosswalk side of the standard.

Attach the sign to the assembly for Type B assemblies.

Attach the sign to the standard using 2 straps and saddle brackets for Type C assemblies.

You may use straps and saddle brackets to secure the push button to the standard.

Use a slip fitter to secure the assembly on top of a 2-1/2-inch-diameter post.

87-1.03V Detectors

87-1.03V(1) General

Installing a detector includes installing inductive loop conductors, sealant, conduit, and pull boxes.

Center the detectors in the traffic lanes.

Do not splice the detector conductor.

87-1.03V(2) Inductive Loop Detectors

Mark the location of the inductive loop detectors such that the distance between the side of the loop and a lead-in saw cut from an adjacent detector is at least 2 feet. The distance between lead-in saw cuts must be at least 6 inches.

Saw cut the slots under section 13-4.03E(7). The bottoms of the slots must be smooth with no sharp edges. For Type E detector loops, saw the slots such that the sides are vertical.

Wash the slots clean using water and blow dry them with compressed air to remove all moisture and debris.

Identify the start of the conductor.

Waterproof the ends of a Type 2 loop conductor before installing it in the conduit to prevent moisture from entering the cable.

Install the loop conductor in the slots and lead-in saw cuts using a 3/16- to 1/4-inch-thick wood paddle. Hold the conductors in place at the bottom of the slot with wood paddles during placement of the sealant.

Wind adjacent loops on the same sensor unit channel in opposite directions.

Twist the conductors for each loop into a pair consisting of a minimum of 2 turns per foot before placing them in the lead-in saw cut and the conduit leading to the pull box. Do not install more than 2 twisted pairs of conductors per lead-in saw cut.

Provide 5 feet of slack in the pull box.

Test each loop for continuity, circuit resistance, and insulation resistance before filling the slots with sealant.

Remove excess sealant from the adjacent road surface before it sets. Do not use solvents to remove the excess.

Identify the loop conductor pair in the pull box, marking the start with the letter *S* and the end with the letter *F*. Band conductors in pairs by lane in the pull box adjacent to the loops and in the cabinet. Identify each pair with the detector designation and loop number.

Install the conductors in a compacted layer of HMA immediately below the uppermost layer if more than one layer will be placed. Install the loop conductors before placing the uppermost layer of HMA. Fill the slot with a sealant flush to the surface.

Install the conductors in the existing pavement if one layer of HMA is to be placed. Install the loop conductors before placing the layer of HMA. Fill the slot with a sealant flush to the surface.

87-1.03V(3) Preformed Inductive Loop Detectors

Construct a preformed inductive loop detector consisting of 4 turns in the loop and a lead-in conductor pair twisted at least 2 turns per foot all encased in conduit and sealed to prevent water penetration. The detector must be 6-foot square unless shown otherwise.

Construct the loop detector using a minimum 3/8-inch Schedule 40 or Schedule 80 PVC or polypropylene conduit and no. 16 or larger conductor with Type THWN or TFFN insulation.

In new roadways, place the detector in the base course with the top of the conduit flush with the top of the base. Cover with HMA or concrete pavement. Protect the detector from damage before and during pavement placement.

In new reinforced concrete bridge decks, secure the detector to the top of the uppermost layer of reinforcing steel using nylon wire ties. Hold the detector parallel to the bridge deck using PVC or polypropylene spacers where necessary. Place conduit for lead-in conductors between the uppermost 2 layers of reinforcing steel.

Do not install detectors in existing bridge decks unless authorized.

Install a detector in existing pavement before placement of concrete or HMA as follows:

1. Saw cut slots at least 1-1/4 inches wide into the existing pavement.
2. Place the detector in the slots. The top of the conduit must be at least 2 inches below the top of the pavement.
3. Test each loop circuit for continuity, circuit resistance, and insulation resistance.
4. Fill saw cuts with elastomeric or hot melt rubberized asphalt sealant for asphalt concrete pavement and with epoxy sealant or hot melt rubberized asphalt sealant for concrete pavement.

87-1.03W Sealants

87-1.03W(1) General

Reserved

87-1.03W(2) Elastomeric Sealant

Apply an elastomeric sealant with a pressure feed applicator.

87-1.03W(3) Asphaltic Emulsion Sealant

Asphaltic emulsion sealant must:

1. Be used for filling slots in asphalt concrete pavement of a maximum width of 5/8 inch
2. Not be used on concrete pavement or where the slope causes the material to run from the slot
3. Be thinned under the manufacturer's instructions
4. Be placed when the air temperature is at least 45 degrees F

87-1.03W(4) Hot-Melt Rubberized Asphalt Sealant

Melt the sealant in a jacketed, double-boiler-type, melting unit. The temperature of the heat transfer medium must not exceed 475 degrees F.

Apply the sealant with a pressure feed applicator or a pour pot when the surface temperature of the pavement is greater than 40 degrees F.

87-1.03X Reserved

87-1.03Y Transformers

Installing a transformer includes placing the transformer inside a pull box, a cabinet, or an enclosure.

Wire the transformer for the appropriate voltage.

Ground the secondary circuit of the transformer as specified in the NEC.

87-1.03Z Reserved

87-1.04 PAYMENT

Not Used

87-2 LIGHTING SYSTEMS

87-2.01 GENERAL

87-2.01A Summary

Section 87-2 includes specifications for constructing lighting systems.

Lighting system includes:

1. Foundations
2. Pull boxes
3. Conduit
4. Conductors
5. Standards
6. Luminaires
7. Service equipment enclosure
8. Photoelectric control
9. Fuse splice connectors
10. High mast lighting assemblies

The components of a lighting system are shown on the project plans.

87-2.01B Definitions

Reserved

87-2.01C Submittals

Submit a certificate of compliance and test data for the high mast lighting luminaires.

87-2.01D Quality Assurance

Reserved

87-2.02 MATERIALS

87-2.02A General

Reserved

87-2.02B High Mast Lighting Assemblies

A high mast lighting assembly includes the foundation, pole, lowering device system, luminaires, and control pedestal.

Each luminaire in a high mast lighting assembly must include a housing, an optical system, and a ballast.

The housing must be made of aluminum.

A painted or powder-coated housing for a high mast lighting luminaire must be able to withstand a 1,000-hour salt spray test as specified in ASTM B117.

The optical system, consisting of the reflector, refractor or lens, lamp socket, and lamp, must be in a sealed chamber. The chamber must be sealed by a gasket between the reflector and refractor or lens and a gasket between the reflector and lamp socket. The chamber must have a separate filter or filtering gasket for flow of air.

An asymmetrical luminaire must have a refractor or reflector that is rotatable 360 degrees around a vertical axis to orient the distribution of light.

The luminaire must have a slip fitter for mounting on a 2-inch horizontal pipe tenon and must be adjustable ± 3 degrees from the axis of the tenon.

The reflector must have a specular surface made of silvered glass or aluminum protected by either an anodized finish or a silicate film. The reflector must be shaped such that a minimum of light is reflected through the arc tube of the lamp.

The refractor and lens must be made of heat-resistant glass.

The lamp socket must be a porcelain-enclosed, mogul-multiple type. The shell must contain integral lamp grips to ensure electrical contact under conditions of normal vibrations. The socket must be rated for 1,500 W, 600 V(ac) and 4,000 V(ac) pulse for a 400 W lamp and 5,000 V(ac) pulse for a 1,000 W lamp.

The luminaire must have a dual fuse holder for 2 fuses rated at 5 A, 480 V(ac). The fuses must be 13/32 inch by 1-1/2 inches, standard midget ferrule type with a nontime-delay feature.

The lamps must be vertical burning, protected from undue vibration, and prevented from backing out of the socket by a stainless steel clamp attached to the luminaire.

A 1,000 W metal halide lamp must have an initial output of 100,000 lumens and an average rated life of 12,000 hours based on 10 hours per start.

A 400 W high-pressure sodium lamp must have an initial output of 50,000 lumens. A 1,000 W high-pressure sodium lamp must have an initial output of 140,000 lumens.

The ballast for the luminaire must be a regulator type and have a core and coils, capacitors, and starting aid.

Ballast must be:

1. Mounted within a weatherproof housing that integrally attaches to the top of a luminaire support bracket and lamp support assembly
2. Readily removable without removing the luminaire from the bracket arm
3. Electrically connected to the optical assembly by a prewired quick disconnect

The ballast for a metal halide luminaire must comply with luminaire manufacturer's specifications.

The wattage regulation spread at any lamp voltage, from nominal through the life of the lamp, must vary no more than 22 percent for a 1,000 W lamp and a ± 10 percent input voltage variation. The ballast's starting line current must be less than its operating current.

87-2.02C Soffit and Wall-Mounted Luminaires

87-2.02C(1) General

Soffit and wall-mounted luminaires must be weatherproof and corrosion resistant.

Each luminaire must include a 70 W high-pressure sodium lamp with a minimum average rated life of 24,000 hours. The lamp socket must be positioned such that the light center of the lamp is located within 1/2 inch of the designed light center of the luminaire.

Luminaire wiring must be SFF-2.

Flush-mounted soffit luminaire must have:

1. Metal body with two 1-inch-minimum conduit hubs and a means of anchoring the body into the concrete
2. Prismatic refractor made of heat-resistant polycarbonate:
 - 2.1. Mounted in a door frame
 - 2.2. With the street side identified
3. Aluminum reflector with a specular anodized finish
4. Ballast located either within the housing or in a ceiling pull box if shown
5. Lamp socket

The door frame assembly must be hinged, gasketed, and secured to the luminaire body with at least 3 machine screws.

A pendant soffit luminaire must be enclosed and gasketed and have an aluminum finish. Luminaire must have:

1. Aluminum reflector with a specular anodized finish
2. Refractor made of heat-resistant polycarbonate
3. Optical assembly that is hinged and latched for lamp access and a device to prevent dropping
4. Ballast designed for operation in a raintight enclosure
5. Galvanized metal box with a gasketed cover, 2 captive screws, and 2 chains to prevent dropping and for luminaire mounting

Wall-mounted luminaire must have:

1. Cast metal body
2. Prismatic refractor:
 - 2.1. Made of glass
 - 2.2. Mounted in a door frame
3. Aluminum reflector with a specular anodized finish
4. Integral ballast
5. Lamp socket
6. Gasket between the refractor and the body
7. At least 2 mounting bolts of minimum 5/16-inch diameter

A cast aluminum body of a luminaire to be cast into or mounted against concrete must have a thick coat of alkali-resistant bituminous paint on all surfaces to be in contact with the concrete.

87-2.02C(2) High-Pressure Sodium Lamp Ballasts

87-2.02C(2)(a) General

A high-pressure sodium lamp ballast must operate the lamp for its rated wattage.

Starting aids for a ballast must be interchangeable between ballasts of the same wattage and manufacturer without adjustment.

The ballast must be provided with a heat-generating component to serve as a heat sink. The capacitor must be placed at the maximum practicable distance from the heat-generating components or thermally shielded to limit the case temperature to 75 degrees C.

The transformer and inductor must be resin impregnated for protection against moisture. Capacitors, except for those in starting aids, must be metal cased and hermetically sealed.

The ballast must have a power factor of 90 percent or greater.

For the nominal input voltage and lamp voltage, the ballast design center must not vary more than 7.5 percent from the rated lamp wattage.

87-2.02C(2)(b) Regulator-Type Ballasts

A regulator-type ballast must be designed such that a capacitance variance of ± 6 percent does not cause more than ± 8 percent variation in the lamp wattage regulation.

The ballast must have a current crest factor not exceeding 1.8 for an input voltage variation of ± 10 percent.

The lamp wattage regulation spread for a lag-type ballast must not vary by more than 18 percent for ± 10 percent input voltage variations. The primary and secondary windings must be electrically isolated.

The lamp wattage regulation spread for a constant-wattage, autoregulator, lead-type ballast must not vary by more than 30 percent for ± 10 percent input voltage variations.

87-2.02C(2)(c) Nonregulator-Type Ballasts

A nonregulator-type ballast must have a current crest factor not exceeding 1.8 for an input voltage variation of ± 5 percent.

The lamp wattage regulation spread for an autotransformer or high reactance type ballast must not vary by more than 25 percent for ± 5 percent input voltage variations.

87-2.03 CONSTRUCTION

87-2.03A General

Set the foundations for standards such that the mast arm is perpendicular to the centerline of the roadway.

Tighten the cap screws of the luminaire's clamping bracket to 10 ft-lb for LED and low-pressure luminaires.

Label the month and year of the installation inside the luminaire housing's door.

Perform the conductor and operational tests for the system.

87-2.03B High Mast Lighting Assemblies

Mount and connect the luminaires to the accessory support ring. Aim the asymmetrical luminaire to orient the distribution of light.

87-2.03C Soffit and Wall-Mounted Luminaires

For a flush-mounted soffit luminaire:

1. Prevent concrete from getting into the housing during pouring of the concrete for the structure
2. Install the luminaire with the axis vertical and the street side of the refractor oriented as indicated
3. Locate the luminaire to provide a minimum 2-foot clearance from the inside surface of the girders and 1-foot clearance from the near face of the diaphragm
4. Install the bridge soffit and ceiling pull box over the same lane

For a pendant soffit luminaire:

1. Cast in place the inserts for the no. 8 pull box during concrete placement for a new structure
2. Drill holes for expansion anchors to support the no. 8 pull box on existing structures
3. Bond the suspension conduit and luminaire to the pull box

For a wall-mounted luminaire, provide:

1. Extension junction box or ring on a new structure
2. 4 external mounting taps on an existing structure

Place the soffits or wall-mounted luminaires in operation as soon as practicable after the falsework has been removed from the structure.

If the Engineer orders soffit or wall-mounted luminaires to be activated before permanent power service is available, installing and removing the temporary power service is change order work.

87-2.04 PAYMENT

Not Used

87-3 SIGN ILLUMINATION SYSTEMS

87-3.01 GENERAL

87-3.01A Summary

Section 87-3 includes specifications for constructing sign illumination systems.

Sign illumination system includes:

1. Foundations
2. Pull boxes
3. Conduit
4. Conductors
5. Sign lighting fixtures
6. Enclosure for the disconnect circuit breaker
7. Service equipment enclosure
8. Photoelectric control

The components of a sign illumination system are shown on the project plans.

87-3.01B Definitions

Reserved

87-3.01C Submittals

Submit the manufacturer's test data for the induction sign-lighting fixtures.

87-3.01D Quality Assurance

Reserved

87-3.02 MATERIALS

An induction sign-lighting fixture must include a housing with a door, reflector, refractor or lens, lamp, socket assembly, power coupler, high-frequency generator, fuse block, and fuses.

The fixture must comply with the isofootcandle curves as shown.

Fixture must weigh no more than 44 lb, be rated for 87 W at 120/240 V(ac), and have a mounting assembly made of one of the following materials:

1. Cast aluminum
2. Hot-dip galvanized steel plate
3. Galvanized steel plate finished with one of the following:
 - 3.1. Polymeric coating
 - 3.2. Same finish used for the housing

Housing must:

1. Be corrosion resistant and suitable for wet locations
2. Be above the top of the mounting rails at a maximum height of 12 inches
3. Have weep holes

Door must:

1. Hold a refractor or lens
2. Open without the use of special tools
3. Have a locking position at 50 degrees minimum from the plane of the door opening
4. Be hinged to the housing on the side of the fixture away from the sign panel
5. Have 2 captive latch bolts or other latching device

When the door is opened, it must lock in the 50 degrees position when an 85 mph, 3-second wind-gust load strikes the door from either side.

The housing and door must be manufactured of sheet or cast aluminum and have a gray powder coat or polyester paint finish. The sheet aluminum must comply with ASTM B209 or B209M for 5052-H32 aluminum sheet. External bolts, screws, hinges, hinge pins, and door closure devices must be corrosion resistant.

The housing and door must be gasketed. The thickness of the gasket must be a minimum of 1/4 inch.

Reflector must not be attached to the outside of the housing and must be:

1. Made of a single piece of aluminum with a specular finish
2. Protected with an electrochemically applied anodized finish or a chemically applied silicate film
3. Designed to drain condensation away from it
4. Secured to the housing with a minimum of 2 screws
5. Removable without removing any fixture parts

Refractor or lens must have a smooth exterior and must be manufactured from the materials shown in the following table:

Refractor and Lens Material Requirements

Component	Material
Flat lens	Heat-resistant glass
Convex lens	Heat-resistant, high-impact-resistant tempered glass
Refractor	Borosilicate heat-resistant glass

The refractor and convex lens must be designed or shielded such that no luminance is visible if the fixture is approached directly from the rear and viewed from below. If a shield is used, it must be an integral part of the door casting.

Lamp must:

1. Be an 85 W induction type with a fluorescent, phosphor-coated, interior wall
2. Have a minimum 70 percent light output of its original lumen output after 60,000 hours of operation
3. Have a minimum color-rendering index of 80
4. Be rated at a color temperature of 4,000K
5. Be removable with common hand tools

The lamp socket must be rated for 1,500 W and 600 V(ac) and be a porcelain-enclosed mogul type with a shell that contains integral lamp grips to ensure electrical contact under normal vibration conditions. The shell and center contact must be made of nickel-plated brass. The center contact must be spring loaded.

The power coupler must be removable with common hand tools.

High-frequency generator must:

1. Start and operate lamps at an ambient temperature of -25 degrees C or greater for the rated life of the lamp
2. Operate continuously at ambient air temperatures from -25 to 55 degrees C without a reduction in the generator life
3. Have a design life of at least 100,000 hours at 55 degrees C
4. Have an output frequency of 2.65 MHz \pm 10 percent
5. Have radio frequency interference that complies with 47 CFR 18 regulations regarding harmful interference
6. Have a power factor greater than 90 percent and total harmonic distortion less than 10 percent

The high frequency generator must be mounted such that the fixture can be used as a heat sink and be replaceable with common hand tools.

Each fixture must include a barrier-type fuse block for terminating field connections. Fuse block must:

1. Be rated 600 V(ac)
2. Have box terminals
3. Be secured to the housing and accessible without removal of any fixture parts
4. Be mounted to leave a minimum of 1/2 inch of air space from the sidewalls of the housing
5. Be designed for easy removal of fuses with a fuse puller

The fixture's fuses must be 13/32-inch-diameter, 1-1/2-inch-long ferrule type and UL listed or NRTL certified. For a 120 V(ac) fixture, only the ungrounded conductor must be fused and a solid connection must be provided between the grounded conductor and the high frequency generator.

The fixture must be permanently marked with the manufacturer's brand name, trademark, model number, serial number, and date of manufacture on the inside and outside on the housing. The same information must be marked on the package.

If a wire guard is used, it must be made of a minimum 1/4-inch-diameter galvanized steel wire. The wires must be spaced to prevent rocks larger than 1-1/2-inch diameter from passing through the guard. The guard must be either hot-dip galvanized or electroplated zinc-coated as specified in ASTM B633, service condition SC4, with a clear chromate dip treatment.

87-3.03 CONSTRUCTION

Perform the conductor and operational tests for the system.

87-3.04 PAYMENT

Not Used

87-4 SIGNAL AND LIGHTING SYSTEMS

87-4.01 GENERAL

87-4.01A Summary

Section 87-4 includes specifications for constructing signal and lighting systems.

Signal and lighting system includes:

1. Foundations
2. Pull boxes
3. Conduit
4. Conductors
5. Cables
6. Standards
7. Signal heads
8. Internally illuminated street name signs
9. Service equipment enclosure
10. Department-furnished controller assembly
11. Detectors
12. Telephone demarcation cabinet
13. Accessible pedestrian signals
14. Push button assemblies
15. Pedestrian signal heads
16. Luminaires
17. Photoelectric control
18. Fuse splice connectors
19. Battery backup system
20. Flashing beacons
21. Flashing beacon control assembly

The components of a signal and lighting system are shown on the project plans.

87-4.01B Definitions

Reserved

87-4.01C Submittals

Submit shop drawings showing the message for each internally illuminated street sign, including the size of letters, symbols, and arrows.

87-4.01D Quality Assurance

87-4.01D(1) General

Reserved

87-4.01D(2) Quality Control

87-4.01D(2)(a) General

Reserved

87-4.01D(2)(b) Battery Backup System

Notify the Engineer 48 hours before testing the battery backup system.

Test the system in the presence of the Engineer by turning off the power to the signal system at the service equipment enclosure. The signal system must run continuously for 30 minutes. If the battery backup system fails, correct the problem and retest the system for another 30 minutes. After successful completion of the test, turn the power on for the signal system.

87-4.02 MATERIALS

87-4.02A General

Reserved

87-4.02B Battery Backup System

A battery backup system includes the cabinet, batteries, and the Department-furnished electronics assembly.

The electronics assembly includes the inverter/charger unit, power transfer relay, and the battery harness.

87-4.02C Internally Illuminated Street Name Signs

An internally illuminated street name sign includes housing, brackets, sign panels, gaskets, ballast, lampholder, terminal blocks, conductors, and fuses.

An internally illuminated street sign must be designed and constructed to prevent deformation or failure when subjected to an 85 mph, 3-second wind-gust load as specified in the AASHTO publication, "Standard Specifications for Structural Supports of Highway Signs, Luminaires and Traffic Signals."

Sign must:

1. Be Types A or B
2. Have galvanized or cadmium-plated ferrous parts
3. Have screened weep holes
4. Have fasteners, screws, and hardware made of passive stainless steel, Type 302 or 304, or aluminum Type 6060-T6
5. Operate at a temperature from -20 to 74 degrees C

Photoelectric unit sockets are not allowed.

The housing must be constructed to resist torsional twist and warp. The housing must be designed such that opening or removing the panels provides access to the interior of the sign for lamp, ballast, and fuse replacement.

The top and bottom of the sign must be manufactured from formed or extruded aluminum and attached to formed or cast aluminum end fittings. The top, bottom, and end fittings must form a sealed housing.

For a Type A sign, both sides of the sign must be hinged at the top to allow installation or removal of the sign panel.

For a Type B sign, the sign panel must be slide mounted into the housing.

The top of the housing must have 2 free-swinging mounting brackets. Each bracket must be vertically adjustable for leveling the sign to either a straight or curved mast arm. The bracket assembly must allow the lighting fixture to swing perpendicular to the sign panel.

The reflectors must be formed aluminum and have an acrylic, baked-white-enamel surface with a minimum reflectance of 0.85.

Sign panel must be translucent, high-impact-resistant, and made of one of the following plastic materials:

1. Glass-fiber-reinforced, acrylated resin
2. Polycarbonate resin
3. Cellulose acetate butyrate

The sign panel must be designed not to crack or shatter if a 1-inch-diameter steel ball weighing 2.4 ounces is dropped from a height of 8.5 feet above the sign panel to any point on the panel. For this test, the sign panel must be lying in a horizontal position and supported within its frame.

The sign panel's surface must be evenly illuminated. The brightness measurements for the letters must be a minimum of 150 foot-lamberts, average. The letter-to-background brightness ratio must be from 10:1 to 20:1. The background luminance must not vary by more than 40 percent from the average background brightness measurement. The luminance of letters, symbols, and arrows must not vary by more than 20 percent from their average brightness measurement.

The sign panel's white or green color must not fade or darken if exposed to an accelerated test of UV light equivalent to 2 years of outdoor exposure.

The sign panel's legend, symbols, arrows, and border on each face must be white on a green background. The background must comply with color no. 14109 of FED-STD-595.

The message must appear on both sides of the sign and be protected from UV radiation. The letters must be 8-inch upper case and 6-inch lower case, series E.

A Type A sign must have a closed-cell, sponge-neoprene gasket installed between the sign panel frame to prevent the entry of water. The gasket must be uniform and even textured.

The sign ballast must be a high-power-factor type for outdoor operation from 110 to 125 V(ac) and 60 Hz and must comply with ANSI C82.1 and C82.2.

The ballast for a Type A sign must be rated at 200 mA. The ballast for a Type B sign must be rated at 430 mA.

Sign lampholder must:

1. Be the spring-loaded type
2. Have silver-coated contacts and waterproofed entrance leads
3. Have a heat-resistant, circular cross section with a partially recessed neoprene ring

Removal of the lamp from the socket must de-energize the primary of the ballast.

The springs for the lampholders must not be a part of the current-carrying circuit.

The sign's wiring connections must terminate on a molded, phenolic, barrier-type, terminal block rated at 15 A, 1,000 V(ac). The connections must have a white, integral, waterproof marking strip. The terminal screws must not be smaller than a no. 10.

The terminal block must be insulated from the fixture to provide protection from the line-to-ground flashover voltage.

A sectionalized terminal block must have an integral barrier on each side and must allow rigid mounting and alignment.

Fixture's conductors must:

1. Be stranded copper wire with a minimum thermoplastic insulation of 28 mils

2. Be rated at 1,000 V(ac) and for use up to 90 degrees C
3. Be a minimum of no. 16
4. Match the color coding of the ballast leads
5. Be secured with spring cross straps, installed 12 inches apart or less in the chassis or fixture

Stranded copper conductors connected to screw-type terminals must terminate in crimp-type ring connectors.

No splicing is allowed within the fixture.

The sign's fuse must be the Type 3AG, miniature, slow-blow type.

The fuse holder must be a panel-mounting type with a threaded or bayonet knob that grips the fuse tightly for extraction. Each ballast must have a separate fuse.

87-4.03 CONSTRUCTION

87-4.03A General

Set the foundations for standards such that the mast arm is perpendicular to the centerline of the roadway.

Tighten the cap screws of the luminaire's clamping bracket to 10 ft-lb for LED and low-pressure luminaires.

Label the month and year of the installation inside the luminaire housing's door.

Perform the conductor and operational tests for the system.

87-4.03B Battery Backup System Cabinets

Install the battery backup system cabinet to the right of the Model 332L cabinet.

If installation on the right side is not feasible, obtain authorization for installation on the left side.

Provide access for power conductors between the cabinets using:

1. 2" nylon-insulated, steel chase nipple
2. 2" steel sealing locknut
3. 2" nylon-insulated, steel bushing

Remove the jumper between the terminals labeled *BBS-1* and *BBS-2* in the 5 position terminal block in the controller cabinet before connecting the Department-furnished electronics assembly.

87-4.03C Internally Illuminated Street Name Signs

Mount the internally illuminated street name sign to the signal mast arm using the adjustable brackets. Connect the conductors to the terminal blocks in the signal head mounting terminal block.

87-4.04 PAYMENT

Not Used

87-5 RAMP METERING SYSTEMS

87-5.01 GENERAL

Section 87-5 includes specifications for constructing ramp metering systems.

Ramp metering system includes:

1. Foundations
2. Pull boxes
3. Conduit
4. Conductors
5. Standards
6. Signal heads
7. Service equipment enclosure
8. Department-furnished controller assembly

9. Detectors
10. Telephone demarcation cabinet

The components of a ramp metering system are shown on the project plans.

87-5.02 MATERIALS

Not Used

87-5.03 CONSTRUCTION

Connect the field wiring to the terminal blocks in the controller cabinet. The Engineer provides you a list of field conductor terminations for each controller cabinet.

Perform the conductor and operational tests for the system.

87-5.04 PAYMENT

Not Used

87-6 TRAFFIC MONITORING STATION SYSTEMS

87-6.01 GENERAL

Section 87-6 includes specifications for constructing traffic monitoring station systems.

Traffic monitoring station system includes:

1. Foundations
2. Pull boxes
3. Conduit
4. Cables
5. Conductors
6. Service equipment enclosure
7. Controller cabinet
8. Detectors
9. Telephone demarcation cabinet

The components of a traffic monitoring station system are shown on the project plans.

87-6.02 MATERIALS

Not Used

87-6.03 CONSTRUCTION

Connect the field wiring to the terminal blocks in the controller cabinet. The Engineer provides you a list of field conductor terminations for the controller cabinet.

Perform the conductor and operational tests for the system.

87-6.04 PAYMENT

Not Used

87-7 FLASHING BEACON SYSTEMS

87-7.01 GENERAL

Section 87-7 includes specifications for constructing flashing beacon systems.

Flashing beacon system includes:

1. Foundations
2. Pull boxes
3. Conduit
4. Conductors
5. Standards
6. Service equipment enclosure
7. Signal heads
8. Flashing beacon control assembly

The components of a flashing beacon system are shown on the project plans.

The flash rate for the flashing beacon must comply with chapter 4L, "Flashing Beacons," of the *California MUTCD*.

The flashing beacon must allow alternating flashing wig-wag operation.

The flashing beacon must have a separate flasher unit installed in the flashing beacon control assembly.

87-7.02 MATERIALS

Flashing beacon control assembly must:

1. Have a NEMA 3R enclosure with a dead front panel and a hasp with a 7/16-inch hole for a padlock. The enclosure must have one of the following finishes:
 - 1.1. Powder coating.
 - 1.2. Hot-dip galvanized coating.
 - 1.3. Factory-applied, rust-resistant prime coat and finish coat.
2. Have barrier-type terminal blocks rated for 25 A, 600 V(ac), made of molded phenolic or nylon material and have plated-brass screw terminals and integral marking strips.
3. Include a solid state flasher complying with section 8 of NEMA standards publication no. TS 1 for 10 A, dual circuits.

87-7.03 CONSTRUCTION

Perform the conductor and operational tests for the system.

87-7.04 PAYMENT

Not Used

87-8-87-11 RESERVED

87-12 CHANGEABLE MESSAGE SIGN SYSTEMS

87-12.01 GENERAL

Section 87-12 includes specifications for constructing changeable message sign systems.

Changeable message sign system includes:

1. Foundations
2. Pull boxes
3. Conduit
4. Conductors
5. Service equipment enclosure
6. Department-furnished controller cabinet
7. Department-furnished changeable message sign
8. Department-furnished wiring harness
9. Service equipment enclosure
10. Sign disconnect

The components of a changeable message sign system are shown on the project plans.

87-12.02 MATERIALS

Not Used

87-12.03 CONSTRUCTION

Install the changeable message sign.

Connect the field wiring to the terminal blocks in the sign assembly and controller cabinet.

The Engineer provides you a list of field conductor terminations for each sign cabinet and controller cabinet.

The Department maintains the sign assemblies.

87-12.04 PAYMENT

Not Used

87-13–87-17 RESERVED

87-18 INTERCONNECTION CONDUIT AND CABLE

87-18.01 GENERAL

Section 87-18 includes specifications for constructing interconnection conduit and cable.

Interconnection conduit and cable includes:

1. Pull boxes
2. Conduit
3. Signal interconnect cables

The components of an interconnection conduit and cable are shown.

87-18.02 MATERIALS

Not Used

87-18.03 CONSTRUCTION

Test the signal interconnect cable.

Connect the signal interconnect cable to the terminal block in the controller cabinets. The Engineer provides you a list of terminations for each controller cabinet.

87-18.04 PAYMENT

Not Used

87-19 RESERVED

87-20 TEMPORARY ELECTRICAL SYSTEMS

87-20.01 GENERAL

Section 87-20 includes specifications for providing temporary electrical systems.

Obtain the Department's authorization for the type of temporary electrical system and its installation method.

A temporary system must operate on a continuous, 24-hour basis.

87-20.02 MATERIALS

87-20.02A General

Material and equipment may be new or used.

The components of a temporary system are shown on the project plans.

If you use Type UF-B cable, the minimum conductor size must be no. 12.

87-20.02B Temporary Flashing Beacon Systems

A temporary flashing beacon system consists of a flashing beacon system, wood post, generator, and photovoltaic system.

The system must comply with the specifications for a flashing beacon system in section 87-7, except it may be mounted on a wood post or a trailer.

87-20.02C Temporary Lighting Systems

A temporary lighting system consists of a lighting system, generator, and wood poles.

The system must comply with the specifications for a lighting system in section 87-2, except it may be mounted on a wood pole or a trailer.

87-20.02D Temporary Signal Systems

A temporary signal system consists of a signal and lighting system, wood poles and posts, and a generator.

System must comply with the specifications for a signal and lighting system in section 87-4, except:

1. Signal heads may be mounted on a wood pole, mast arm, tether wire, or a trailer
2. Flashing beacons may be mounted on a wood post, or a trailer

87-20.03 CONSTRUCTION

87-20.03A General

Provide electrical and telecommunication services for temporary systems. Do not use existing services unless authorized.

Provide power for the temporary electrical systems under section 12-3.33, except you may use a photovoltaic system for the temporary flashing beacon system.

Install conductors and cables in a conduit, suspended from wood poles at least 25 feet above the roadway, or use direct burial conductors and cables.

You may saw slots across paved areas for burial conductors and cables.

Install conduit outside the paved area at a minimum of 12 inches below grade for Type 1 and 2 conduit and at a minimum of 18 inches below grade for Type 3 conduit.

Install direct burial conductors and cables outside the paved area at a minimum depth of 24 inches below grade.

Place the portions of the conductors installed on the face of wood poles in either Type 1, 2, or 3 conduit between the point 10 feet above grade at the pole and the pull box. The conduit between the pole and the pull box must be buried at a depth of at least 18 inches below grade.

Place conductors across structures in a Type 1, 2, or 3 conduit. Attach the conduit to the outside face of the railing.

Mount the photoelectric unit at the top of the standard or wood post.

You may abandon in place conductors and cables in sawed slots or in conduit installed below the ground surface.

87-20.03B Temporary Flashing Beacon Systems

Install a fused-splice connector in the pull box adjacent to each flashing beacon. Wherever conductors are run overhead, install the splice connector in the line side outside of the control assembly.

87-20.03C Temporary Lighting Systems

Wherever conductors are run overhead, install the fuse splice connectors in the line side before entering the mast arm.

87-20.03D Temporary Signal Systems

You may splice conductors that run to a terminal compartment or a signal head on a pole to the through conductors of the same phase in a pull box adjacent to the pole. Do not splice conductors or cables except in a pull box or in a NEMA 3R enclosure.

The Department provides the timing for the temporary signal.

Maintain the temporary signal except for the Department-furnished controller assembly.

87-20.04 PAYMENT

Not Used

87-21 EXISTING ELECTRICAL SYSTEMS

87-21.01 GENERAL

Section 87-21 includes general specifications for performing work on existing electrical systems.

87-21.02 MATERIALS

Not Used

87-21.03 CONSTRUCTION

87-21.03A General

You may abandon unused underground conduit after pulling out all conductors and removing conduit terminations from the pull boxes.

If standards are to be salvaged, remove:

1. All components
2. Mast arms from the standards
3. Luminaires, signal heads, and signal mounting assemblies from the standards and mast arms

If the existing material is unsatisfactory for reuse and the Engineer orders you to replace it with new material, replacing the existing material with new material is change order work.

If the removed electrical equipment is to be reinstalled, supply all materials and equipment, including signal mounting assemblies, anchor bolts, nuts, washers, and concrete, needed to complete the new installation.

87-21.03B Maintaining Existing Electrical Systems

87-21.03B(1) General

Maintain the existing electrical system in working order during the progress of the work. Conduct your operations to avoid damage to the elements of the systems.

87-21.03B(2) Maintaining Existing Traffic Management System Elements During Construction

Section 87-21.02B(2) applies if a bid item for maintaining existing traffic management system elements during construction is shown on the Bid Item List.

Traffic management system elements include:

1. Ramp metering system
2. Traffic monitoring stations
3. Microwave vehicle detection system
4. Changeable message sign system
5. Extinguishable message sign system
6. Highway advisory radio system
7. Closed circuit television camera system
8. Roadway weather information system

Obtain authorization at least 72 hours before interrupting communication between an existing system and the traffic management center.

If the Engineer notifies you that an existing system is not fully operational due to your activities, repair or replace the system within 72 hours. If the system cannot be fixed within 72 hours or it is located on a structure, provide a temporary system within 24 hours until the system can be fixed. Perform a functional test of the system in the presence of the Engineer. If you fail to perform the necessary repair or replacement work, the Department may perform the repair or replacement work and deduct the cost.

If you damage an existing fiber optic cable, install a new cable such that the length of cable slack is the same as before the damage, measured from an original splice point or termination. All splices must be made using the fusion method.

You may interrupt the operation of traffic monitoring stations:

1. For 60 days if another operational traffic monitoring station is located within 3 miles

For volumetric proportioning of RPC:

1. The volumetric container must be imprinted with manufacturer's name, model number, serial number, the as-calibrated volume and date of the last calibration. Cross sectional dimensions of the container must remain the same as those during its calibration.
2. The device must be re-calibrated monthly and at any time when the container shape has been deformed from its original condition or there is evidence of material build-up on the inside of the device.
3. The device must be held in a level condition during filling. Fill the device to the measure or strike-off line. Each measurement must be filled to within 1.0% of the device as-calibrated volume.
4. The device interior must be cleaned after each measurement to maintain a zero condition.

For weight proportioning, proportion RPC with a weigh hopper attached to the plant at a position which allows the addition of the RPC to the mixer truck with the conventional PCC ingredients. The plant process controller must control the proportioning of RPC to within 1.0% of its target weight.

90-9.02 MATERIALS

90-9.02A General

The quantity of RPC added to the concrete must not exceed 15 percent.

The cementitious material content of the RPC must be at least that specified for the concrete that allows the use of RPC.

Water must not be added to the RPC after batching, including in the truck mixer.

Use HSA for controlling and reducing the hydration rate of RPC.

Incorporate RPC by mixing into the concrete before arriving at the jobsite.

90-9.02B Returned Plastic Concrete

The RPC must not exceed 100 degrees F at any time.

If HSA is not used, RPC must be incorporated into the concrete before attaining initial set or within 4 hours after batching of RPC, whichever is earlier.

If HSA is used:

1. Add HSA to RPC within 4 hours after original batching.
2. Measure and record the time, dosage of HSA, and temperature of RPC when HSA is added.
3. Mix the RPC under the HSA manufacturer's instructions after adding HSA or at least 30 revolutions, whichever is greater.
4. Incorporate RPC into the concrete within 4 hours after adding HSA.

RPC must not contain:

1. Accelerating admixture
2. Fiber
3. Pigment
4. Lightweight aggregate
5. Previously returned RPC
6. Any ingredient incompatible with the resultant concrete

90-9.02C Hydration Stabilizing Admixture

HSA must comply with ASTM C494 admixture Type B or Type D.

HSA must have a proven history of specifically maintaining and extending both plasticity and set.

HSA dosage must comply with the manufacturer's instructions.

90-9.02D Production

Proportion concrete containing RPC under section 90-2.02E.

BID BOOK

BITUMINOUS SEAL COATS VARIOUS LOCATIONS IN FRESNO COUNTY

BUDGET / ACCOUNT: 4510 / 7370



Department of Public Works and Planning

CONTRACT NUMBER 20-14-M

BID BOOK TABLE OF CONTENTS

BITUMINOUS SEAL COATS CONTRACT NUMBER 20-14-M

PROPOSAL NUMBER(S)	TITLE
NOT APPLICABLE	INSTRUCTIONS FOR COMPLETING THE BID BOOK
1	PROPOSAL TO THE BOARD OF SUPERVISORS OF THE COUNTY OF FRESNO
2	BID ITEM LIST
3	EVALUATION OF BID ITEM LIST
4	BID SECURITY
5	NON-COLLUSION DECLARATION
6	PUBLIC CONTRACT CODE SECTION 10285.1 STATEMENT
7	PUBLIC CONTRACT CODE SECTION 10162 QUESTIONNAIRE AND PUBLIC CONTRACT CODE 10232 STATEMENT
8(A) – 8(C)	SUBCONTRACTORS
9 - 15	NOT USED
16	OPT OUT OF PAYMENT ADJUSTMENTS FOR PRICE INDEX FLUCTUATIONS
17	GUARANTY

INSTRUCTIONS FOR COMPLETING THE BID BOOK FOR NON-FEDERAL AID PROJECTS

General

Complete forms in the *Bid* book.

Submit an electronic bid online at <http://www.BidExpress.com> (Section 2-1.33D) or submit a hardcopy bid:

1. Under sealed cover addressed to the Department and labeled with the name of the bidder, the name of the project and the statement 'Do Not Open Until The Time Of Bid Opening.'
2. Marked as a bid
3. Identifying the contract number and the bid opening date

Certain bid forms must be submitted with the bid and properly executed.

Certain other forms and information must be submitted either with the bid or within the prescribed period after bid opening as specified elsewhere in these special provisions.

Failure to submit the forms and information as specified results in a nonresponsive bid.

If an agent other than the authorized corporation officer or a partnership member signs the bid, file a Power of Attorney with the Department either before opening bids or with the bid. Otherwise, the bid may be nonresponsive.

Bid Item List and Bid Comparison

Submit a bid based on the bid item quantities the Department shows on the Bid Item List. Bids will be evaluated and the low bidder determined as indicated in the *Notice to Bidders*.

Bid Document Completion

Proposal items are identified by title and by the word "Proposal" followed by the number assigned to the proposal item in question. Proposal items are included in the *Bid Book*.

Proposal to the Board of Supervisors of Fresno County – Proposal 1

Provided for information.

Bid Item List – Proposal 2

One or more sheet(s) or list(s) upon which the bidder completes the bid.

Fill out completely including a unit price and total for each unit price-based item and a total for each lump sum item.

Do not make any additions such as "plus tax", "plus freight", or conditions such as "less 2% if paid by 15th".

Use ink or typewriter for paper bids.

Evaluation of Bid Item List – Proposal 3

Describes how inconsistencies and irregularities are evaluated and corrected when Design Services reviews the Bid Item List.

Bid Security and Signature – Proposal 4

Submit one of the following forms of bidder's security equal to at least 10 percent of the bid:

- Cash
- Cashier's check
- Certified check
- Signed bidder's bond by an admitted surety insurer

Indicate type of bid security provided.

- Cash – Acceptable but not recommended. Cash is deposited in a clearing account and is returned to bidders by County warrant. This process may take several weeks.
- Cashier's or Certified Checks. This type of security is held until the bid is no longer under consideration. If submitted by a potential awardee, they will be returned when the contract is fully executed by the bidder and bonds and insurance have been approved.
- Bid Bonds - Must be signed by the bidder and by the attorney-in-fact for the bonding company. Provide notarized signature of attorney-in-fact accompanied by bonding company's affidavit authorizing attorney-in-fact to execute bonds. An unsigned bid bond will be cause for rejection.

Acknowledge Addenda

Provide contractor's license information.

State business name and if business is a:

- Corporation - list officers
- Partnership - list partners
- Joint Venture - list members; if members are corporations or partnerships, list their officers or partners.
- Individual - list Owner's name and firm name style

Signature of Bidder - the following lists types of companies and corresponding authorized signers.

- Corporation - by an officer
- Partnership - by a partner
- Joint Venture - by a member
- Individual - by the Owner

If signature is by a Branch Manager, Estimator, Agent, etc., the bid must be accompanied by a power of attorney authorizing the individual to sign the bid in question or to sign bids more generally, otherwise the bid may be rejected.

- Business Address - Firm's Street Address
- Mailing Address - P.O. Box or Street Address
- Complete, sign, and return with bid.

Noncollusion Declaration – Proposal 5

Must be completed, signed, and returned with bid.

Public Contract Code Section 10285.1 Statement – Proposal 6

Select “has” or “has not” in accordance with instructions on form, return with completed for with bid. Note that signing the bid constitutes signing this statement.

Public Contract Code Section 10162 Questionnaire And Public Contract Code 10232 Statement – Proposal 7

Select “yes” or “no” accordance with instructions on form, include explanation if “yes” is selected. Return completed form with bid. Note that signing the bid constitutes signing this questionnaire and statement.

Subcontractors – Proposal 8(a) through Proposal 8(c)

Sheet(s) or spaces where bidders list subcontractors. List each subcontractor to perform work in an amount in excess of 1/2 of 1 percent of the total bid or \$10,000, whichever is greater (Pub Cont Code § 4100 et seq.).

The *Subcontractor List* submitted with the bid must show the name, location of business, work portions to be performed, and the contractor’s license number for each subcontractor listed.

- Use subcontractor's business name style as registered with the License Board.
- Specify the city in which the subcontractor’s business is located and the state if other than California.
- Description of the work to be performed by the subcontractor. Indicate with bid item numbers from the bid item list and/or work descriptions similar to those on bid item list.
- List license number for each subcontractor.

Upon request from Design Services, provide the following additional information within 24 hours of bid opening if not included on the *Subcontractor List* submitted with the bid:

- Complete physical address for each subcontractor listed.
- Percentage of the total bid or dollar amount associated with each subcontractor listed.
- Department of Industrial Relations registration number.

Proposal 9 - Proposal 15 – Not Used

Proposal 16 - *Opt out of payment adjustments for price index fluctuations*

You may opt out of the payment adjustments for price index fluctuations specified in section 9-1.07. To opt out, submit a completed *Opt Out of Payment Adjustments for Price Index Fluctuations* form with your bid.

Guaranty - Proposal 17

Does not need to be signed with the bid. Part of the contract which must be signed by the contractor when contract is executed.

PROPOSAL TO THE BOARD OF SUPERVISORS OF THE COUNTY OF FRESNO

hereinafter called the Owner

BITUMINOUS SEAL COATS

VARIOUS LOCATIONS IN FRESNO COUNTY

The work embraced herein shall be done in accordance with the 2015 Standard Specifications and with the 2015 Standard Plans, of the State of California, Department of Transportation insofar as the same may apply and in accordance with these special provisions.

Except to the extent that they may conflict with these special provisions, revised Standard Specifications apply to the extent included in the section entitled "Project Details" of the book entitled "Specifications."

The undersigned, as bidder, declares that the only persons, or parties interested in this proposal as principals are those named herein, that this proposal is made without collusion with any other person, firm or corporation; that he has carefully examined the location of the proposed work, the annexed proposed form of contract, and the plans therein referred to; and he proposes and agrees if this proposal is accepted, that he will contract with the Owner to provide all necessary machinery, tools, apparatus and other means of construction, and to do all the work and furnish all the materials specified in the contract in the manner and time therein prescribed, and according to the requirements of the Engineer as therein set forth, and that he will take in full payment therefor the following unit prices, to-wit:

COUNTY OF FRESNO
DEPARTMENT OF PUBLIC WORKS AND PLANNING
PROJECT: BITUMINOUS SEAL COATS
CONTRACT NO: 20-14-M

ITEM NO.	ESTIMATED QUANTITY	F,S	UNIT OF MEASURE	ITEM	ITEM PRICE (IN FIGURES)	TOTAL PRICE (IN FIGURES)
1	25,000		\$	SUPPLEMENTAL WORK	\$1	\$25,000
2	25,000		\$	SUPPLEMENTAL WORK (PAYMENT ADJUSTMENT FOR PRICE INDEX FLUCTUATION)	\$1	\$25,000
3	1		LS	TRAFFIC CONTROL SYSTEM		
4	1		LS	JOB SITE MANAGEMENT		
5	600		SQYD	TEMPORARY COVER		
6	1		LS	PREPARE WATER POLLUTION CONTROL PROGRAM		
7	24		EA	ADVANCE NOTIFICATION SIGN		
8	33		EA	TEMPORARY DRAINAGE INLET PROTECTION		
9	1,581		TON	SAND COVER		
10	565		TON	POLYMER ASPHALTIC EMULSION (SEAL COAT)		
11	5,256		TON	SCREENINGS (3/8")		
12	142		TON	ASPHALTIC EMULSION (FLUSH COAT)		
13	99,610		LF	4" THERMOPLASTIC TRAFFIC STRIPE (SPRAYABLE) (DETAILS 1, 5, 6)		
14	16,038		LF	4" THERMOPLASTIC TRAFFIC STRIPE (SPRAYABLE) (DETAILS 15, 18, 19)		
15	43,696		LF	4" THERMOPLASTIC TRAFFIC STRIPE (SPRAYABLE) (DETAILS 21, 22, 28, 29)		
16	17,550		LF	PAINT TRAFFIC STRIPE (2-COAT) (DETAILS 39, 39A)		
17	126		SF	PAINT PAVEMENT MARKING (2-COAT) (BIKELANE SYMBOL)		
18	168,200		LF	4" THERMOPLASTIC TRAFFIC STRIPE (SPRAYABLE) (DETAIL 27B)		
19	1,630		LF	4" THERMOPLASTIC TRAFFIC STRIPE (SPRAYABLE) (DETAILS 38, 38A)		
20	64,951		LF	REMOVE THERMOPLASTIC TRAFFIC STRIPE		
21	2,706		EA	PAVEMENT MARKER (TYPE D)		
22	27		EA	PAVEMENT MARKER (TYPE H)		
23	2,733		EA	REMOVE PAVEMENT MARKER (TYPES D, H)		
24	180		EA	PAVEMENT MARKER (BOTTS' DOTS)		
25	180		EA	REMOVE PAVEMENT MARKER (BOTTS' DOTS)		
26	1,518		SF	THERMOPLASTIC PAVEMENT MARKING		
27	335		SF	REMOVE THERMOPLASTIC PAVEMENT MARKING		
28	1		LS	MOBILIZATION		
TOTAL BID (ITEMS 1 THROUGH 28)						

Proposal 2.0

Contract No: 20-14-M

EVALUATION OF BID PROPOSAL ITEM LIST

Abbreviations used in the bid proposal sheet are identified in Section 1-1.06, "Abbreviations," of these special provisions.

Bids are required for the entire work. Bids will be compared on the basis indicated in the Notice to Bidders. The bidder shall set forth for each unit basis item of work a unit price and a total for the item, and for each lump sum item a total for the item, all in clearly legible figures in the respective spaces provided for that purpose. In the case of unit basis items, the amount set forth under the "Item Total" column shall be the product of the unit price bid and the estimated quantity for the item.

In case of discrepancy between the unit price and the total set forth for a unit basis item, the unit price shall prevail, except as provided in (a) or (b), as follows:

- (a) If the amount set forth as a unit price is unreadable or otherwise unclear, or is omitted, or is the same as the amount as the entry in the item total column, then the amount set forth in the item total column for the item shall prevail and shall be divided by the estimated quantity for the item and the price thus obtained shall be the unit price;
- (b) (Decimal Errors) If the product of the entered unit price and the estimated quantity is exactly off by a factor of ten, one hundred, etc., or one-tenth, or one-hundredth, etc. from the entered total, the discrepancy will be resolved by using the entered unit price or item total, whichever most closely approximates percentage-wise the unit price or item total in the Owner's Final Estimate of cost.

If both the unit price and the item total are unreadable or otherwise unclear, or are omitted, the bid may be deemed irregular. Likewise, if the item total for a lump sum item is unreadable or otherwise unclear, or is omitted, the bid may be deemed irregular unless the project being bid has only a single item and a clear, readable total bid is provided.

Symbols such as commas and dollar signs will be ignored and have no mathematical significance in establishing any unit price or item total or lump sums. Written unit prices, item totals and lump sums will be interpreted according to the number of digits and, if applicable, decimal placement. Cents symbols also have no significance in establishing any unit price or item total since all figures are assumed to be expressed in dollars and/or decimal fractions of a dollar. Bids on lump sum items shall be item totals only; if any unit price for a lump sum item is included in a bid and it differs from the item total, the item total shall prevail.

The foregoing provisions for the resolution of specific irregularities cannot be so comprehensive as to cover every omission, inconsistency, error or other irregularity which may occur in a bid. Any situation not specifically provided for will be determined in the discretion of the Owner, and that discretion will be exercised in the manner deemed by the Owner to best protect the public interest in the prompt and economical completion of the work. The decision of the Owner respecting the amount of a bid, or the existence or treatment of an irregularity in a bid, shall be final.

If this proposal shall be accepted and the undersigned shall fail to contract, as aforesaid, and to give the two bonds in the sums to be determined as aforesaid, with surety satisfactory to the Owner, within eight (8) days not including Saturdays, Sundays and legal holidays, after the bidder has received notice of award of the contract, the Owner, at its option, may determine that the bidder has abandoned the contract, and thereupon this proposal and the acceptance thereof shall be null and void, and the forfeiture of such security accompanying this proposal shall operate and the same shall be the property of the Owner.

BID SECURITY AND SIGNATURE

Accompanying this proposal is security (check one only) in amount equal to at least ten percent (10%) of the total amount of the bid:

Bid Bond (); Certified Check (); Cashier's Check (); Cash (\$)

Bidder has and acknowledges the following addenda:_____

The names of all persons interested in the foregoing proposal as principals are as follows:

IMPORTANT NOTICE: If bidder or other interested person is a corporation, state legal name of corporation, also names of the president, secretary, treasurer and manager thereof; if a co-partnership, state true name of firm, also names of all individual co-partners composing firm; if bidder or other interested person is an individual, state first and last name in full.

FIRM NAME _____

Licensed in accordance with an act providing for the registration of Contractors,

Class _____ License No. _____ Expires _____

DIR Registration Number _____

Signature of Bidder

Dated

NOTE: If bidder is a corporation, the legal name of the corporation shall be set forth above together with the signature of the officer or officers authorized to sign contracts on behalf of the corporation; if bidder is a co-partnership, the true name of the firm shall be set forth above together with the signature of the partner or partners authorized to sign contracts on behalf of the co-partnership; and if bidder is an individual, his signature shall be placed above. If signature is by an agent, other than an officer of a corporation or a member of a partnership, a Power of Attorney must be on file with the Owner prior to opening bids or submitted with the bid; otherwise, the bid will be disregarded as irregular and unauthorized.

BUSINESS ADDRESS: _____
Zip Code

MAILING ADDRESS: _____
Zip Code

BUSINESS PHONE: (_____) _____ FAX NUMBER: (_____) _____

EMAIL ADDRESS _____

To the Board of Supervisors, County of Fresno:

NONCOLLUSION DECLARATION

TO BE EXECUTED BY BIDDER AND SUBMITTED WITH BID*

The undersigned declares:

I am the _____ of
(Owner, Partner, Corporate Officer (list title), Co-Venturer)

_____, the party making the foregoing bid.

The bid is not made in the interest of, or on behalf of, any undisclosed person, partnership, company, association, organization, or corporation. The bid is genuine and not collusive or sham. The bidder has not directly or indirectly induced or solicited any other bidder to put in a false or sham bid. The bidder has not directly or indirectly colluded, conspired, connived, or agreed with any bidder or anyone else to put in a sham bid, or refrain from bidding. The bidder has not in any manner, directly or indirectly, sought by agreement, communication, or conference with anyone to fix the bid price of the bidder or any other bidder, or to fix any overhead, profit, or cost element of the bid price, or of that of any other bidder. All statements contained in the bid are true. The bidder has not, directly or indirectly, submitted his or her bid price or any breakdown thereof, or the contents thereof, or divulged information or data relative thereto, to any corporation, partnership, company, association, organization, bid depository, or to any member or agent thereof, and has not paid, and will not pay, any person or entity for that purpose.

Any person executing this declaration on behalf of a bidder that is a corporation, partnership, joint venture, limited liability company, limited liability partnership, or any other entity, hereby represents that he or she has full power to execute, and does execute, this declaration on behalf of the bidder.

I declare under penalty of perjury under the laws of the State of California that the foregoing is true and correct and that this declaration is executed on _____, 2021,

at _____, _____.”
[city] [state]

(Signature)

(See Title 23 United States Code Section 112; Calif Public Contract Code Section 7106)

*NOTE: Completing, signing, and returning the Non-Collusion Declaration is a required part of the Proposal. Bidders are cautioned that making a false certification may subject the certifier to criminal prosecution.

PUBLIC CONTRACT CODE

Public Contract Code Section 10285.1 Statement

In conformance with Public Contract Code Section 10285.1 (Chapter 376, Stats. 1985), the bidder hereby declares under penalty of perjury under the laws of the State of California that the bidder has _____, has not _____ been convicted within the preceding three years of any offenses referred to in that section, including any charge of fraud, bribery, collusion, conspiracy, or any other act in violation of any state or Federal antitrust law in connection with the bidding upon, award of, or performance of, any public works contract, as defined in Public Contract Code Section 1101, with any public entity, as defined in Public Contract Code Section 1100, including the Regents of the University of California or the Trustees of the California State University. The term "bidder" is understood to include any partner, member, officer, director, responsible managing officer, or responsible managing employee thereof, as referred to in Section 10285.1.

Note: The bidder must place a check mark after "has" or "has not" in one of the blank spaces provided. The above Statement is part of the Bid. Signing this Bid on the signature portion thereof shall also constitute signature of this Statement. Bidders are cautioned that making a false certification may subject the certifier to criminal prosecution.

Public Contract Code Section 10162 Questionnaire

In conformance with Public Contract Code Section 10162, the Bidder shall complete, under penalty of perjury, the following questionnaire:

Has the bidder, any officer of the bidder, or any employee of the bidder who has a proprietary interest in the bidder, ever been disqualified, removed, or otherwise prevented from bidding on, or completing a federal, state, or local government project because of a violation of law or a safety regulation?

Yes _____ No _____

If the answer is yes, explain the circumstances in the following space.

Public Contract Code 10232 Statement

In conformance with Public Contract Code Section 10232, the Contractor, hereby states under penalty of perjury, that no more than one final unappealable finding of contempt of court by a federal court has been issued against the Contractor within the immediately preceding two-year period because of the Contractor's failure to comply with an order of a federal court which orders the Contractor to comply with an order of the National Labor Relations Board.

Note: The above Statement and Questionnaire are part of the Bid. Signing this Bid on the signature portion thereof shall also constitute signature of this Statement and Questionnaire.

Bidders are cautioned that making a false certification may subject the certifier to criminal prosecution.

BIDDER: _____

SUBCONTRACTORS:

The following named subcontractor(s) will perform with labor, or otherwise render services to the general contractor in or about the construction of the work or improvement in an amount in excess of one-half of one percent of the total bid presented herewith **or \$10,000, whichever is greater**. Please fill out as completely as possible when submitting your bid. Use subcontractor's business name style as registered with the License Board. Each listed subcontractor's name, location of business and description of work, and both their contractor's license number and public works contractor registration number, issued pursuant to Section 1725.5 of the Labor Code, are **REQUIRED**, by Section 4104 of the California Public Contract Code, to be submitted prior to bid opening. (The "location of business" must specify the city in which the subcontractor's business is located, and the state if other than California.) All other requested information shall be submitted, either with the bid or within 24 hours after bid opening.

Please fill out as completely as possible when submitting your bid. Use subcontractor's business name style as registered with the License Board.

FAILURE TO LIST SUBCONTRACTORS AS DIRECTED MAY RENDER THE BID NON-RESPONSIVE, OR MAY RESULT IN ASSESSMENT OF A PENALTY AGAINST THE BIDDER IN ACCORDANCE WITH SECTION 4110 OF THE CALIFORNIA PUBLIC CONTRACT CODE.

<p>SUBCONTRACTOR: _____</p> <p>Business Address: _____</p> <p>Class ____ License No. _____ DIR Registration No. _____</p> <p>Item No. or Description of Work: _____</p> <p>Dollar Amount _____ OR Percentage of Total Bid _____</p> <p>Email Address: _____</p>
<p>SUBCONTRACTOR: _____</p> <p>Business Address: _____</p> <p>Class ____ License No. _____ DIR Registration No. _____</p> <p>Item No. or Description of Work: _____</p> <p>Dollar Amount _____ OR Percentage of Total Bid _____</p> <p>Email Address: _____</p>

<p>SUBCONTRACTOR: _____</p> <p>Business Address: _____</p> <p>Class ____ License No. _____ DIR Registration No. _____</p> <p>Item No. or Description of Work: _____</p> <p>Dollar Amount _____ OR Percentage of Total Bid _____</p> <p>Email Address: _____</p>
<p>SUBCONTRACTOR: _____</p> <p>Business Address: _____</p> <p>Class ____ License No. _____ DIR Registration No. _____</p> <p>Item No. or Description of Work: _____</p> <p>Dollar Amount _____ OR Percentage of Total Bid _____</p> <p>Email Address: _____</p>
<p>SUBCONTRACTOR: _____</p> <p>Business Address: _____</p> <p>Class ____ License No. _____ DIR Registration No. _____</p> <p>Item No. or Description of Work: _____</p> <p>Dollar Amount _____ OR Percentage of Total Bid _____</p> <p>Email Address: _____</p>
<p>SUBCONTRACTOR: _____</p> <p>Business Address: _____</p> <p>Class ____ License No. _____ DIR Registration No. _____</p> <p>Item No. or Description of Work: _____</p> <p>Dollar Amount _____ OR Percentage of Total Bid _____</p> <p>Email Address: _____</p>
<p>SUBCONTRACTOR: _____</p> <p>Business Address: _____</p> <p>Class ____ License No. _____ DIR Registration No. _____</p> <p>Item No. or Description of Work: _____</p> <p>Dollar Amount _____ OR Percentage of Total Bid _____</p> <p>Email Address: _____</p>

SUBCONTRACTOR: _____
Business Address: _____
Class ____ License No. _____ DIR Registration No. _____
Item No. or Description of Work: _____
Dollar Amount _____ **OR** Percentage of Total Bid _____
Email Address: _____

SUBCONTRACTOR: _____
Business Address: _____
Class ____ License No. _____ DIR Registration No. _____
Item No. or Description of Work: _____
Dollar Amount _____ **OR** Percentage of Total Bid _____
Email Address: _____

SUBCONTRACTOR: _____
Business Address: _____
Class ____ License No. _____ DIR Registration No. _____
Item No. or Description of Work: _____
Dollar Amount _____ **OR** Percentage of Total Bid _____
Email Address: _____

OPT OUT OF PAYMENT ADJUSTMENTS FOR PRICE INDEX FLUCTUATIONS

You may opt out of the payment adjustments for price index fluctuations as specified in Section 2-1.31, "OPT OUT OF PAYMENT ADJUSTMENTS FOR PRICE INDEX FLUCTUATIONS," of the special provisions.

You can only elect to opt out of payment adjustments for price index fluctuations of if you complete this form and submit it with your bid. The individual signing this form must be duly authorized to sign a bid.

By signing this form, I hereby opt out of the payment adjustments for price index fluctuations for the above-named project.

Bidder: _____

Name (Printed): _____

Signature: _____

Title: _____

**Proposal 16
CONTRACT NUMBER 20-14-M**

(This guaranty shall be executed by the successful bidder in accordance with instructions in the special provisions. The bidder may execute the guaranty on this page at the time of submitting his bid.)

G U A R A N T Y

To the Owner: County of Fresno

CONTRACT NUMBER 20-14-M

The undersigned guarantees the construction and installation of the following work included in this project:

ALL WORK

Should any of the materials or equipment prove defective or should the work as a whole prove defective, due to faulty workmanship, material furnished or methods of installation, or should the work or any part thereof fail to operate properly as originally intended and in accordance with the plans and specifications, due to any of the above causes, all within twelve (12) months after date on which this contract is accepted by the Owner, the undersigned agrees to reimburse the Owner, upon demand, for its expenses incurred in restoring said work to the condition contemplated in said project, including the cost of any such equipment or materials replaced and the cost of removing and replacing any other work necessary to make such replacement or repairs, or, upon demand by the Owner, to replace any such material and to repair said work completely without cost to the Owner so that said work will function successfully as originally contemplated.

The Owner shall have the unqualified option to make any needed replacement or repairs itself or to have such replacements or repairs done by the undersigned. In the event the Owner elects to have said work performed by the undersigned, the undersigned agrees that the repairs shall be made and such materials as are necessary shall be furnished and installed within a reasonable time after the receipt of demand from the Owner.

Name (Printed): _____

Signature: _____

Title: _____

Date: _____

Contractor: _____

Proposal 17
CONTRACT NUMBER 20-14-M

A G R E E M E N T

THIS AGREEMENT made at Fresno, in Fresno County, California, by and between _____ hereinafter called the Contractor, and the County of Fresno hereinafter called the Owner.

WITNESSETH: That the Contractor and the Owner, for the consideration hereinafter named, agree as follows:

ARTICLE I. The Contractor agrees to furnish all labor and materials, including tools, implements, and appliances required, but excluding such materials as are mentioned in the specifications to be furnished by the Owner, and to perform all the work in a good and workmanlike manner, free from any and all liens and claims of mechanics, materialmen, teamsters, subcontractors, artisans, machinists, and laborers required for:

BITUMINOUS SEAL COATS

VARIOUS LOCATIONS IN FRESNO COUNTY

CONTRACT NUMBER: 20-14-M

All in strict compliance with the plans, drawings and specifications therefor prepared by the Owner, and other contract documents relating thereto.

ARTICLE II. The Contractor and the Owner agree that the Notice to Bidders and Special Provisions, the Wage Scale (Prevailing Wages), the Plans and Drawings, Addenda and Bulletins thereto, and the Proposal (Bid Book) hereto attached, together with this Agreement, form the contract, and they are as fully a part of the contract as if hereto attached or herein repeated.

All portions of the Standard Specifications of the State of California, Department of Transportation, dated 2015, which are not in conflict with this contract shall be deemed a part of the specifications as though fully therein set forth; provided, however, that revisions to the said Standard Specifications shall apply only to the extent, if any, included in the Project Details of these specifications or as otherwise incorporated directly herein. No part of said specifications which is in conflict with any portion of this agreement, or which is not actually descriptive of the work to be done thereunder, or of the manner in which said work is to be executed, shall be considered as any part of this agreement, but shall be utterly null and void.

ARTICLE III. The Owner agrees to pay the Contractor in current funds for the performance of the contract the sum of _____ **DOLLARS AND xx/100** (_____._____) it being understood that said price is based upon the estimated quantities of materials to be used as set forth in the Proposal, except where provisions are made in the contract documents whereby the estimated quantities shall constitute the final quantity; that upon completion of the project the final contract prices shall be revised by change order, if necessary, to reflect the true quantities used at the stated unit price thereof as contained in the Contractor's Proposal hereto attached. Payments on account thereof will be made as set forth in the special provisions.

ARTICLE IV. If the Contractor should be adjudged a bankrupt, or if he should make a general assignment for the benefit of his creditors, or if a receiver should be appointed on account of his insolvency, or if he or any of his subcontractors should persistently violate any of the provisions of the contract, or if he should persistently or repeatedly refuse or should fail, except in cases for which extension of time is provided, to supply enough properly skilled workmen or proper materials, or if he

CONTRACT NUMBER 20-14-M

should fail to make prompt payment to subcontractors or for material or labor, or persistently disregard laws, ordinances or the instructions of the Engineer, then the Owner may, upon certificate of the Engineer when sufficient cause exists to justify such action, serve written notice upon the Contractor and his surety of its intention to terminate the contract, and unless within five days after the serving of such notice, such violations shall cease and satisfactory arrangements for correction thereof be made, the contract shall, upon the expiration of said five days, cease and terminate.

In the event of any such termination, the Owner shall immediately serve written notice thereof upon the surety and the Contractor, and the surety shall have the right to take over and perform the contract, provided, however, that if the surety within ten (10) days after the serving upon it of notice of termination does not give the Owner written notice of its intention to take over and perform the contract or does not commence performance thereof within the ten (10) days stated above from the date of the serving of such notice, the Owner may take over the work and prosecute the same to completion by contract or by any other method it may deem advisable, for the account and at the expense of the Contractor, and the Contractor and his surety shall be liable to the Owner for any excess cost occasioned the Owner thereby, and in such event the Owner may without liability for so doing, take possession of and utilize in completing the work such materials, appliances, plant and other property belonging to the Contractor as may be on the site of the work and necessary therefor. In such case the Contractor shall not be entitled to receive any further payment until the work is finished. If the unpaid balance of the contract price shall exceed the expenses of finishing the work, including compensation for additional managerial and administrative services, such excess shall be paid to the Contractor. If such expense shall exceed such unpaid balance, the Contractor shall pay the difference to the Owner. The expense incurred by the Owner, as herein provided and damage incurred through the Contractor's default, shall be certified by the Engineer.

ARTICLE V. To the fullest extent permitted by law with respect to any work required to be done under this contract, the Contractor will indemnify and hold harmless the COUNTY OF FRESNO, and all other participating public agencies, whether or not said agencies are named herein, who have jurisdiction within the areas in which the work is to be performed, and all officers and employees of the Owner, the County, the State, the United States and said other participating agencies, from any and all costs and expenses, attorney fees and court costs, damages, liabilities, claims and losses occurring or resulting to COUNTY in connection with the performance, or failure to perform, by CONTRACTOR, its officers, agents or employees under this Agreement, and from any and all costs and expenses, attorney fees and court costs, damages, liabilities, claims and losses occurring or resulting to any person, firm or corporation who may be injured or damaged by the performance, or failure to perform, of CONTRACTOR, its officers, agents or employees under this Agreement. In addition, CONTRACTOR agrees to indemnify COUNTY for Federal, State of California and/or local audit exceptions resulting from non-compliance herein on the part of CONTRACTOR.

CONTRACTOR agrees to indemnify, save, hold harmless, and at COUNTY'S request, defend the COUNTY, its officers, agents, and employees from any and all costs and expenses, damages, liabilities, claims, and losses occurring or resulting to COUNTY in connection with the performance, or failure to perform, by CONTRACTOR, its officers, agents, or employees under this Agreement, and from any and all costs and expenses, damages, liabilities, claims, and losses occurring or resulting to any person, firm, or corporation who may be injured or damaged by the performance, or failure to perform, of CONTRACTOR, its officers, agents, or employees under this Agreement.

The Certificate of Insurance shall be issued in duplicate, to the COUNTY OF FRESNO and all other participating agencies, whether or not said agencies are named herein, who contribute to the cost of the work or have jurisdiction over areas in which the work is to be performed and all officers and employees of said agencies while acting within the course and scope of their duties and responsibilities.

In the event CONTRACTOR fails to keep in effect at all times insurance coverage as herein provided, the COUNTY may, in addition to other remedies it may have, suspend or terminate this Agreement upon the occurrence of such event.

All policies shall be with admitted insurers licensed to do business in the State of California. Insurance purchased shall be purchased from companies possessing a current A.M Best Company rating of A FSC VII or better.

Without limiting the COUNTY’S right to obtain indemnification from CONTRACTOR or any third parties, CONTRACTOR, at its sole expense, shall maintain in full force and effect, the following insurance policies or a program of self-insurance, including but not limited to, an insurance pooling arrangement or Joint Powers Agreement (JPA) throughout the term of the Agreement:

A. Commercial General Liability

Commercial General Liability Insurance with limits not less than those shown in the following table:

Liability Insurance Requirements

Total bid	For each occurrence ^a	Aggregate for products/completed operation	General aggregate ^b	Umbrella or excess liability ^c
≤ \$1,000,000	\$1,000,000	\$2,000,000	\$2,000,000	\$5,000,000
> \$1,000,000	\$1,000,000	\$2,000,000	\$2,000,000	\$10,000,000
≤ \$10,000,000				
> \$10,000,000	\$2,000,000	\$2,000,000	\$4,000,000	\$15,000,000
≤ \$25,000,000				
> \$25,000,000	\$2,000,000	\$2,000,000	\$4,000,000	\$25,000,000

^aCombined single limit for bodily injury and property damage.

^bThis limit must apply separately to your work under this Contract.

^cThe umbrella or excess policy must contain a clause stating that it takes effect (drops down) in the event the primary limits are impaired or exhausted.

This policy shall be issued on a per occurrence basis. COUNTY may require specific coverages including completed operations, products liability, contractual liability, Explosion-Collapse-Underground, fire legal liability, or any other liability insurance deemed necessary because of the of the nature of this contract.

Such Commercial General Liability insurance shall name the County of Fresno, its officers, agents, and employees, individually and collectively, as additional insured, but only insofar as the operations under this Agreement are concerned. Such coverage for additional insured shall apply as primary insurance and any other insurance, or self-insurance, maintained by COUNTY, its officers, agents and employees shall be excess only and not contributing with insurance provided under CONTRACTOR's policies herein. This insurance shall not be cancelled or changed without a minimum of thirty (30) days advance written notice given to COUNTY. CONTRACTOR shall obtain endorsements to the Commercial General Liability insurance policy naming COUNTY as an additional insured and providing for a thirty (30) day prior written notice of cancellation or change in terms or coverage.

Within eight (8) days from date CONTRACTOR executes this Agreement, CONTRACTOR shall provide certificates of insurance and endorsement as stated above for all of the foregoing policies, as required herein, to the County of Fresno or to designservices@fresncountyca.gov, stating that such insurance coverages have been obtained and are in full force; that the County of Fresno, its officers, agents and employees will not be responsible for an premiums on the policies; that such Commercial General Liability insurance names the County of Fresno, its officers, agents, and employees, individually and collectively, as additional insured, but only insofar as the operations under this Agreement are concerned; that such coverage for additional insured shall apply as primary insurance an any other

insurance, or self- insurance shall not be cancelled or changed without a minimum of thirty (30) days advance, written notice given to COUNTY.

CONTRACTOR shall obtain endorsements to the Commercial General Liability insurance naming the County of Fresno, its officers, agents, and employees, individually and collectively, as additional insured, but only insofar as the operations under this Agreement are concerned. Such coverage for additional insured shall apply as primary insurance and any other insurance, or self-insurance, maintained by COUNTY, its officers, agents, and employees shall be excess only and not contributing with insurance provided under CONTRACTOR'S policies herein. This insurance shall not be cancelled or changed without a minimum or thirty (30) days advance written notice given to COUNTY.

B. Automobile Liability

Comprehensive Automobile Liability Insurance with limits of not less than One Million Dollars (\$1,000,000) per accident for bodily injury and property damage. Coverage should include owned and non-owned vehicles used in connection with this Agreement and all applicable endorsements.

C. Professional Liability

If CONTRACTOR is a licensed professional or employs professional staff, (e.g., Architect, Engineer, Surveyor, etc.) in providing services, Professional Liability Insurance with limits of not less than One Million Dollars (\$1,000,000.00) per occurrence, Three Million Dollars (\$3,000,000.00) annual aggregate with a provision for 3 year tail coverage.

D. Worker's Compensation

A policy of Worker's Compensation insurance as may be required by the California Labor Code.

ARTICLE VI. Contractor represents that he has secured the payment of Worker's Compensation in compliance with the provisions of the Labor Code of the State of California and during the performance of the work contemplated herein will continue so to comply with said provisions of said Code. Contractor shall supply the Owner with certificates of insurance, in duplicate, evidencing that Worker's Compensation Insurance is in effect and providing that the Owner will receive ten days notice of cancellation. If Contractor self-insures Worker's Compensation, Certificate of Consent to Self-insure should be provided the Owner.

ARTICLE VII. The Contractor shall forthwith furnish in duplicate, a faithful performance bond in an amount equal to 100% of the contract price and a payment bond in an amount equal to 100% of the contract price, both bonds to be written by a surety company acceptable to the Owner and in the form prescribed by law.

The payment bond shall contain provisions such that if the Contractor or his subcontractors shall fail to pay (a) amounts due under the Unemployment Insurance Code with respect to work performed under the contract, or (b) any amounts required to be deducted, withheld and paid over to the Employment Development Department and to the Franchise Tax Board from the wages of the employees of the Contractor and subcontractors pursuant to Section 13020 of the Unemployment Insurance Code with respect to such work and labor, then the surety will pay these amounts. In case suit is brought upon the payment bond, the surety will pay a reasonable attorney's fee to be fixed by the court.

ARTICLE VIII. This project is subject to compliance monitoring and enforcement by the Department of Industrial Relations.

Except as provided in Labor Code section 1725.5(f), no contractor or subcontractor may be listed on a bid proposal for a public works project unless registered with the Department of Industrial Relations pursuant to Labor Code section 1725.5 [with limited exceptions from this requirement for bid purposes only under Labor Code section 1771.1(a)].

Except as provided in Labor Code section 1725.5(f), no contractor or subcontractor may be awarded a contract for public work on a public works project or engage in the performance of work on any public works project unless registered with the Department of Industrial Relations pursuant to Labor Code section 1725.5.

Contractor shall comply with all applicable laws and regulations relating to wages and employment, including all requirements imposed by the California Department of Industrial Relations (DIR). Contractor shall cooperate with County to furnish timely all information necessary for County's completion of the form required to be submitted by County when registering the Project on the DIR website; and County thereafter shall provide to Contractor the "Project ID Number" assigned by DIR in order to facilitate Contractor's submission to DIR of its certified payrolls for the Project, in the manner required and using such form as may be prescribed by DIR, in accordance with the provisions of Labor Code section 1771.4(a)(3).

ARTICLE IX: Governing Law – Venue for any action arising out of or relating to this Agreement shall be in Fresno County, California. This Agreement shall be governed by the laws of the State of California.

This Contract, **20-14-M**, was awarded by the Board of Supervisors on _____. It has been reviewed by the Department of Public Works and Planning and is in proper order for signature of the Chairman of the Board of Supervisors.

IN WITNESS WHEREOF, they have executed this Agreement this _____ day of _____, 2021

(CONTRACTOR)

COUNTY OF FRESNO
(OWNER)

(Taxpayer Federal I.D. No.)

By _____

By _____
Steve Brandau, Chairman
of the Board of Supervisors of the
County of Fresno

Title _____

ATTEST:
Bernice E. Seidel
Clerk of the Board of Supervisors
County of Fresno, State of California

By _____
Deputy