



# County of Fresno

DEPARTMENT OF PUBLIC WORKS AND PLANNING  
STEVEN E. WHITE, DIRECTOR

## Planning Commission Staff Report Agenda Item No. 2 February 13, 2020

**SUBJECT:** Initial Study Application No. 7568 and Classified Conditional Use Permit Application No. 3632

Allow an agricultural commercial center consisting of an approximately 6-acre flea market with related improvements on a 78.18-acre parcel in AE-40 (Exclusive Agricultural, 40-acre minimum parcel size) Zone District.

**LOCATION:** The project is located on the north side of W. Jayne Avenue approximately 2,556 feet west of its intersection with El Dorado Avenue and 6.4 miles east of the nearest city limits of City of Coalinga (23436 W. Jayne Avenue, Coalinga) (Sup. Dist. 4) (APN 073-090-20S).

**OWNER:** Rito Gutierrez  
**APPLICANT:** Luis Bravo

**STAFF CONTACT:** Ejaz Ahmad, Planner  
(559) 600-4204

Marianne Mollring, Senior Planner  
(559) 600-4569

### RECOMMENDATION:

- Recommend adoption of the Mitigated Negative Declaration prepared for Initial Study (IS) Application No. 7568; and
- Recommend approval of the Master Plan prepared for the Agricultural Commercial Center; and
- Recommend approval of Classified Conditional Use Permit (CUP) No. 3632 with recommended Findings and Conditions; and
- Direct the Secretary to prepare a Resolution documenting the Commission's action and forwarding the above recommendation to the Board of Supervisors.

**EXHIBITS:**

1. Mitigation Monitoring, Conditions of Approval and Project Notes
2. Location Map
3. Existing Zoning Map
4. Existing Land Use Map
5. Agricultural Commercial Center Master Plan/Elevations
6. Applicant’s Submitted Operational Statement
7. Summary of Initial Study Application No. 7568
8. Draft Mitigated Negative Declaration

**SITE DEVELOPMENT AND OPERATIONAL INFORMATION:**

<b>Criteria</b>	<b>Existing</b>	<b>Proposed</b>
General Plan Designation	Westside Rangeland in the Coalinga Regional Plan	No change
Zoning	AE-40 (Exclusive Agricultural, 40-acre minimum parcel size)	No change
Parcel Size	78.18 acres	No change
Project Site	Undeveloped	Allow an agricultural commercial center consisting of an approximately 6-acre flea market with related improvements on a 78.18-acre parcel.
Structural Improvements	None	<ul style="list-style-type: none"> <li>• Vendors’ stalls</li> <li>• Restrooms</li> <li>• Music platform/sitting area under canopy</li> <li>• Fruit/vegetable stalls under canopy</li> <li>• Vendors’ parking</li> <li>• Patrons’ parking</li> </ul>
Nearest Residence	Approximately 2,000 feet to the east	No change
Surrounding Development	Single-family residence, Coalinga State Hospital	No change

<b>Criteria</b>	<b>Existing</b>	<b>Proposed</b>
Operational Features	N/A	<p>The proposed agricultural commercial center (flea market) will:</p> <ul style="list-style-type: none"> <li>• Allow outdoor merchandise sale in a field in designated lots or under a tent, selling or bartering used goods, collectibles, or antiques, including sale of food items from mobile food trucks.</li> <li>• Operate three days in a week (Friday, Saturday, Sunday)</li> <li>• Draw approximately 500 visitors (customers, patrons, members)</li> </ul>
Employees	N/A	Five
Customers or Visitors	N/A	500 (estimated)
Traffic Trips	N/A	<p>Per the Traffic Impact Analysis (TIA) prepared by JBL Traffic Engineering, Inc., the project at build-out would generate a maximum of:</p> <ul style="list-style-type: none"> <li>• 4,794 daily trips</li> <li>• 248 AM peak-hour trips</li> <li>• 140 PM peak-hour trips.</li> </ul>
Lighting	N/A	Lighting within vendors' stalls and within parking area
Hours of Operation	N/A	From 5 a.m. to 10 p.m. on Friday, Saturday and Sunday

**ENVIRONMENTAL ANALYSIS:**

An Initial Study (IS) was prepared for the project by County staff in conformance with the provisions of the California Environmental Quality Act. Based on the IS, staff has determined that a Mitigated Negative Declaration is appropriate. A summary of the Initial Study is below and included as Exhibit 7.

Notice of Intent to Adopt a Mitigated Negative Declaration publication date: January 13, 2020

## **PUBLIC NOTICE:**

Notices were sent to 9 property owners within 1,320 feet of the subject parcel, exceeding the minimum notification requirements prescribed by the California Government Code and County Zoning Ordinance.

## **PROCEDURAL CONSIDERATIONS:**

According to Section 867.A.1.r. of the Zoning Ordinance, a Classified CUP is required to allow an agricultural commercial center consisting of a flea market in the AE-40 (Exclusive Agricultural, 40-acre minimum parcel size) Zone District.

A Conditional Use Permit for an agricultural commercial center may be approved only if five findings specified in the Zoning Ordinance Section 873-F are made by the Board of Supervisors.

Per Section 873.E.2 of the Fresno County Zoning Ordinance, the Planning Commission's action on agricultural commercial centers is advisory to the Board. Should the Planning Commission recommend approval, a subsequent hearing date before the Board of Supervisors will be scheduled as close to the Commission's action as practical to make the final decision on the classified Conditional Use Permit. Information for that hearing will be provided under separate notice.

## **BACKGROUND INFORMATION:**

The project site is a grazing land located near the City of Coalinga. Adjacent land to the north and east is also grazing land. The California Department of Fish and Wildlife Pleasant Valley Ecological Reserves are located to the west and south of the property. Most agricultural fields with farming operations are located approximately 1.5 miles to the east and sparse agricultural fields are located to the south and west of the project site. The nearest residential dwelling is located approximately 2,000 feet to the east, and Coalinga State Hospital is located 0.8 mile west of the project site.

The proposed improvements include vendors' stalls, restrooms, music platform/sitting area under canopy, fruit/vegetable stalls under canopy, and vendors' and patrons' parking. The restroom building and canopies will be permanent structures on the property. Vendors' stalls under tents are removeable and will be setup at the start of the business day and will be removed at the end of business day. The project site gains access from Jayne Avenue via separate designated access for vendors and patrons.

As a point of note, the California Department of Toxic Substances Control (CDTSC) reviewed the Initial Study (IS) prepared for the project during the public comment period and suggested that the potential for site activities to result in the release of hazardous wastes/substances be evaluated in the Hazards and Hazardous Materials Section of the Initial Study. The changes have been included as Mitigation Measures in **bold/underline** in Section IX. A. B. C. HAZARDS AND HAZARDOUS MATERIALS of Initial Study No. 7568 (Exhibit 7).

*Finding 1: That the site of the proposed use is adequate in size and shape to accommodate said use and all yards, spaces, walls and fences, parking, loading, landscaping, and other features required by this Division, to adjust said use with land and uses in the neighborhood*

	<b>Current Standard:</b>	<b>Proposed Operation:</b>	<b>Is Standard Met (y/n)</b>
Setbacks	Front: 35 feet Side: 20 feet Street Side: 25 feet Rear: 20 feet	Front (south property line): 220 feet Rear (north property line): 1,960 feet Side (east property line): 120 feet Side (west property line): 740 feet	Yes
Parking	Two (2) square feet of off-street parking area for each one square foot of commercial floor area	127 parking spaces required (201 parking spaces provided, including six handicap-accessible spaces)	Yes
Lot Coverage	No requirement	No requirement	N/A
Separation Between Buildings	Six-foot minimum	N/A	N/A
Wall Requirements	No requirement	No requirement	N/A
Septic Replacement Area	100 percent	100 percent	Yes
Water Well Separation	Septic tank: 50 feet; Disposal field: 100 feet; Seepage pit: 150 feet	Will utilize the existing onsite well	Yes

Zoning Section of the Fresno County Department of Public Works and Planning: The proposed improvements meet the building setback requirements of the AE-20 Zone District. Completion of a Site Plan Review is recommended as a Condition of Approval.

No other comments specific to the adequacy of the site were expressed by reviewing Agencies or Departments.

**Analysis:**

Staff review of the Site Plan demonstrates that the 78.18-acre project site can accommodate all improvements related to the proposed agricultural commercial center (flea market) which includes vendors' stalls, restrooms, music platform/sitting area under canopy, fruit/vegetable stalls under canopy, and parking for vendors and patrons. All improvements will be set back approximately 220 feet from the south property line (35 feet required along Jayne Avenue), 1,960 feet from the north property line (20 feet required), 120 feet from the east property line (20 feet required) and 740 feet from the west property line (20 feet required), and meet the minimum building setback requirements of the AE-20 Zone District.

Regarding off-street parking, the Zoning Ordinance requires two square feet of off-street parking area for each one square foot of commercial floor area, and the California Building Code requires one parking space for the physically handicapped per every 25 parking spaces. According to the Site Plan Review Unit of the Fresno County Department of Public Works and Planning, the project requires 127 parking spaces. The Applicant-submitted project Site Plan (Exhibit 5) depicts 201 parking spaces (including handicapped-accessible spaces), which meets the requirement.

Based on the above information, staff believes that the project site is adequate in size and shape to accommodate the proposal.

**Recommended Conditions of Approval:**

*None.*

**Conclusion:**

Finding 1 can be made.

*Finding 2: That the site for the proposed use relates to streets and highways adequate in width and pavement type to carry the quantity and kind of traffic generated by the proposed use*

		<b>Existing Conditions</b>	<b>Proposed Operation</b>
Private Road	No	N/A	N/A
Public Road Frontage	Yes	Jayne Avenue; fair condition	No change
Direct Access to Public Road	Yes	Jayne Avenue	No change
Road ADT (Average Daily Traffic)		4600	No change
Road Classification		Rural Expressway	No change
Road Width		90 feet of road right-of-way for Jayne Avenue (60 feet north and 30 feet south of section line)	No change
Road Surface		Asphalt	Additional pavement construction may be required for the widening of Jayne Avenue to accommodate the left-turn lane into the patrons' access driveway off Jayne Avenue.
Traffic Trips		N/A	Per the Traffic Impact Analysis (TIA) prepared for the project

		Existing Conditions	Proposed Operation
			by JBL Traffic Engineering, Inc., at build-out, the project is estimated to generate a maximum of: <ul style="list-style-type: none"> <li>• 4,794 daily trips</li> <li>• 248 AM peak-hour trips</li> <li>• 140 PM peak-hour trips.</li> </ul>
Traffic Impact Study (TIS) Prepared	Yes		The Traffic Impact Analysis prepared for the project was reviewed and approved by the County's Design and Road Maintenance and Operations Divisions, and the California Department of Transportation. Suggested Mitigation Measures have been included in the project.
Road Improvements Required		Jayne Avenue; fair condition	See "Road Surface" above

**Reviewing Agency/Department Comments:**

Design Division of the Fresno County Department of Public Works and Planning: Per the Traffic Impact Analysis recommendations, the project proponent shall construct an eastbound left-turn lane of such length recommended by a traffic engineer and approved by the County on Jayne Avenue into the patron access driveway.

The California Department of Transportation: Per the Traffic Impact Analysis recommendations, should traffic impacts be observed for either the northbound or southbound off-ramp at the Interstate 5 and Jayne Avenue interchange, the project proponent shall prepare a Transportation Management Plan to alleviate such impacts.

The Road Maintenance and Operations Division of the Fresno County Department of Public Works and Planning: A Traffic Management Plan shall be prepared to include a 220-foot-long driveway off Jayne Avenue as a queueing area, excluding visitors' checkpoint/fee collection and the existing 60-foot right-of-way north of Jayne Avenue.

The above-noted requirements have been included as Mitigation Measures.

Any public access to the parcel shall be provided with right- and left-turn lanes off Jayne Avenue and be improved as part of the frontage improvements. The 220-foot-long public access driveway prior to entry into the visitor parking area shall be paved and shall include a paved drive approach that ties into Jayne Avenue. The vendor access drive shall be paved for the first 100 feet and shall include a paved drive approach that ties into Jayne Avenue. Onsite signs shall indicate that vendor access is for vendors only and be restricted for use only during the set-up operations at the start of the day and the tear-down operations at the end of the day. All

other times during the day, traffic shall be confined to the patrons' access only. Patrons' parking and circulation areas shall be surfaced with base rock and be covered with either asphalt concrete grindings or road oil.

The above-noted requirements have been included as Conditions of Approval.

Development Engineering Section of the Fresno County Department of Public Works and Planning: A 30-foot by 30-foot corner cut-off for sight distance purposes shall be maintained at the proposed drive approaches. This has been included as a Project Note.

**Analysis:**

The project site fronts Jayne Avenue which is a County-maintained road from El Dorado to Solano Alignment, is in fair condition, has pavement width of 32 feet, and carries Average Daily Traffic of 4,600.

Jayne Avenue is classified as a rural Expressway in the County General Plan, requiring 106 feet to 126 feet of road right-of-way. There is 90 feet of road right-of-way (60 feet north of the section line and 30 feet south of the section line) existing for Jayne Avenue.

Per the Design and Road Maintenance and Operations Divisions of the Fresno County Department of Public Works and Planning and the California Department of Transportation review of the Traffic Impact Analysis (TIA) prepared for the project and discussed in the TRANSPORTATION Section of the Initial Study (Exhibit 7), with the Mitigation Measures incorporated in project, the project impact on Jayne Avenue and adjacent road intersections would be less than significant.

Based on the above information, and with adherence to the Mitigation Measures, recommended Conditions of Approvals, and mandatory Project Notes, staff believes Jayne Avenue at the project site can accommodate the traffic generated by the proposal.

**Recommended Conditions of Approval:**

*See Mitigation Measures, recommended Conditions of Approval and mandatory Project Notes attached as Exhibit 1.*

**Conclusion:**

Finding 2 can be made.

*Finding 3: That the proposed use will have no adverse effect on abutting property and surrounding neighborhood or the permitted use thereof*

<b>Surrounding Parcels</b>				
	Size:	Use:	Zoning:	Nearest Residence:
North	119.4 acres	Grazing land	AE-40	None
South	156 acres 6.52 acres	Grazing land	AE-40	None



Surrounding Parcels				
East	78 acres	Grazing land	AE-40	2,000 feet
West	316.3 acres	Pleasant Valley Ecological Reserve	AE-40	None

**Reviewing Agency Comments:**

California Department of Fish and Wildlife (CDFW): To mitigate impact on special-status species, the project shall adhere to Mitigation Measures recommended by CDFW in its February 11, 2019 letter. (Note: The CDFW suggested mitigation measures have been included in Exhibit 1 of this report, and a Biological Habitat Assessment prepared by Colibri Ecological Consulting, LLC, dated April 2019 was provided to CDFW.)

U.S. Fish and Wildlife Service (USFWS): A habitat assessment of the project site shall be conducted by a qualified biologist to determine whether the site contains suitable habitat for San Joaquin kit fox and blunt-nosed leopard lizard. (Note: A Biological Habitat Assessment prepared by Colibri Ecological Consulting, LLC, dated April 2019 was provided to USFWS.)

State Water Resources Control Board (SWRCB), Division of Drinking Water (DDW): The proposed facility shall be permitted as a public water system classified as a transient non-community water system and shall comply with Senate Bill (SB) 1263. The Bill requires that prior to applying for a permit for a proposed new public water system, the Applicant first submit a preliminary technical report before initiating construction of any water-related improvement, which will analyze the feasibility of connecting to an existing community water system for water service. The Applicant shall conduct water quality testing of the existing well in accordance with the requirements for a community water system, as the wells proposed to provide drinking water must be demonstrated to meet Title 22 drinking water standards. The Applicant shall obtain a permit to operate the public water system from SWRCB-DDW.

California Department of Toxic Substances Control (DTSC): If buildings or other structures are to be demolished on any project site included in the proposed project, surveys shall be conducted for the presence of lead-based paints or products, mercury, asbestos-containing materials, and polychlorinated biphenyl caulk. Removal, demolition and disposal of any of the above-mentioned chemicals shall be conducted in compliance with California environmental regulations and policies. In addition, sampling near current and/or former buildings shall be conducted in accordance with *DTSC's 2006 Interim Guidance Evaluation of School Sites with Potential Contamination from Lead Based Paint, Termiticides, and Electrical Transformers*.

If any projects initiated as part of the proposed project require the importation of soil to backfill any excavated areas, proper sampling shall be conducted to ensure that the imported soil is free of contamination and the imported materials are characterized according to *DTSC's 2001 Information Advisory Clean Imported Fill Material*.

If any sites included as part of the proposed project have been used for agricultural, weed abatement or related activities, the current and former agricultural lands shall be evaluated in accordance with *DTSC's 2008 Interim Guidance for Sampling Agricultural Properties (Third Revision)*.

The above-noted requirements have been included as Mitigation Measures.

Fresno County Agricultural Commissioner's Office: The Applicant shall acknowledge the Fresno County Right-to-Farm Ordinance regarding the inconveniences and discomfort associated with normal farm activities surrounding the proposed development. This requirement has been included as a Condition of Approval.

San Joaquin Valley Air Pollution Control District: The project shall adhere to Regulation VIII (Fugitive PM10 Prohibitions); Rule 4601 (Architectural Coatings); Rule 4641 (Cutback, Slow Cure, and Emulsified Asphalt Paving and Maintenance Operations); Rule 4102 (Nuisance); and Rule 9510 (Indirect Source Review).

Fresno County Department of Public Health, Environmental Health Division (Health Department): An onsite sewage disposal system shall be installed under permit and inspection by the Department of Public Works and Planning, Building and Safety Section. If any underground storage tank(s) are found during construction, the Applicant shall apply for and secure an Underground Storage Tank Removal Permit from the Health Department. To protect groundwater, all abandoned water wells on the parcel shall be properly destroyed by an appropriately-licensed contractor. Prior to destruction of agricultural wells, a sample of the uppermost fluid in the well column shall be checked for lubricating oil. Should lubricating oil be found in the well, the oil shall be removed from the well prior to placement of fill material for destruction. The "oily water" removed from the well must be handled in accordance with federal, state and local government requirements.

Fresno County Fire Protection District: The project shall comply with the California Code of Regulations Title 24 – Fire Code, require approval of County-approved site plans by the Fire District prior to issuance of building permits by the County, and annex to Community Facilities District No. 2010-01 of the Fresno County Fire Protection District.

Development Engineering Section of the Fresno County Department of Public Works and Planning: An Engineered Grading and Drainage Plan and a grading permit shall be required for the project. Any proposed entrance gate shall be set back a minimum of 20 feet from the road right-of-way line or the length of the longest truck entering the site and shall not swing outward. An encroachment permit from the Road Maintenance and Operations Division is required for any work done within the road right-of-way. Accessible parking stalls shall be paved, and the path of travel shall be a hard surface per County codes. All storm water runoff shall be retained on site per County standards.

Site Plan Review (SPR) Unit of the Fresno County Department of Public Works and Planning: A dust palliative should be required on all unpaved parking and circulation areas. Proposed driveways shall be a minimum of 24 feet and a maximum of 35 feet in width and be asphalt concrete paved as approved by the Road Maintenance and Operations Division. Parking spaces shall be constructed in compliance with the County and the state standards. All proposed signs shall be submitted to the Department of Public Works and Planning permits counter to verify compliance with the Zoning Ordinance. Proposed landscape improvement area of 500 square feet or more shall comply with California Code of Regulations Title 23, Division 2, Chapter 2.7 Model Water Efficient Landscape Ordinance (MWELo) and require submittal of Landscape and Irrigation plans per the Governor's Drought Executive Order of 2015. The Landscape and Irrigation plans shall be submitted to the SPR unit for review and approval prior to the issuance of Building Permits.

Building and Safety Section of the Department of the Fresno County Department of Public Works and Planning: Plans, permits and inspections shall be required for all onsite improvements.

Mapping unit of the Fresno County Department of Public Works and Planning: Prior to site development, all survey monumentation (Property Corners, Section Corners, County benchmarks, Federal benchmarks and triangulation stations) within the subject area shall be preserved in accordance with Section 8771 of the Professional Land Surveyors Act and Section 6730.2 of the Professional Engineers Act.

The above-noted requirements have been included as Project Notes.

Water and Natural Resources Division of the Fresno County Department of Public Works and Planning; Regional Water Quality Control Board; Westlands Water District: No concerns with the proposal.

### **Analysis:**

The project site is a grazing land located approximately 6.4 miles east of the City of Coalinga. Adjacent land to its north and east is also grazing land. The California Department of Fish and Wildlife Pleasant Valley Ecological Reserve is located to the west and south of the property. Most agricultural land is located approximately 1.5 miles to the east; however, some sparse agricultural lands are also located to the south and west of the project site. The Coalinga State Hospital is located 0.8 mile to the west, and a residential dwelling is located approximately 2,000 feet to the east of the project site.

The proposed agricultural commercial center (flea market) will utilize an approximately 6-acre portion of a 78.18-acre project site to be improved with vendors' stalls, music platform/sitting area under canopy, fruit/vegetable stalls under canopy, restrooms, and vendors' and patrons' parking. The remainder 72.18 acres of the site will remain in the current state as a grazing land and undisturbed by the project. The project will operate three days a week (Friday, Saturday and Sunday).

An Initial Study prepared for the project has identified potential impacts to aesthetics, air quality, biological resources, cultural resources, hazards and hazardous materials, hydrology and water quality, and transportation. To mitigate impact to aesthetics, all outdoor lighting will be hooded and directed downward to avoid glare on adjoining properties. To mitigate impact to air quality, the project will adhere to Regulation VIII to reduce the short-term construction period air quality impacts. To mitigate impact on biological resources, the project will adhere to the Mitigation Measures recommended by CDFW and those contained in the Biological Habitat Assessment prepared for the project. To mitigate impact to cultural resources, any artifacts/human remains unearthed during ground disturbance will require stopping of all work and the evaluation of findings by an archeologist. To mitigate impact related to hazards and hazardous materials, the project will comply with the California Department of Toxic Substances Control requirements. To mitigate impact to hydrology and water quality, the project will comply with SWRCB-DDW requirements for a public water system. To mitigate impact to transportation, the project will require construction of an eastbound left-turn lane and the preparation of traffic management plans. With adherence to these requirements, included as Mitigation Measures (Exhibit 1), the project impact on abutting properties and the surrounding area would be less than significant.

Potential impacts related to agriculture and forestry resources, geology and soils, and public services are less than significant. The project will acknowledge the Fresno County Right-to-Farm Ordinance regarding the inconveniences and discomfort associated with normal farm

activities surrounding the proposed development; require Engineered Grading Plans and a Grading Permit; adhere to the current Fire Codes and Building Code; and annex to Community Facilities District No. 2010-01 of the Fresno County Fire Protection District. These requirements have been included as a Condition of Approval and Project Notes, and will be addressed through the Site Plan Review recommended as a Condition of Approval.

Pursuant to Assembly Bill (AB) 52, the subject proposal was routed to the Santa Rosa Rancheria Tachi Yokut Tribe, Picayune Rancheria of the Chukchansi Indians, and Dumna Wo Wah Tribal Government offering them an opportunity to consult under Public Resources Code (PRC) Section 21080.3(b) with a 30-day window to formally respond to the County letter. No tribe requested consultation, resulting in no further action on the part of the County. Because the property is moderately sensitive to archaeological resources, a Mitigation Measure has been included in the CULTURAL ANALYSIS section of this report (Exhibit 7); implementation of which will reduce impact to tribal cultural resources to less than significant.

Based on the above information and with adherence to the Mitigation Measures, recommended Conditions of Approval, and mandatory Project Notes identified in the Initial Study (IS) prepared for this project and discussed in this Staff Report, staff believes the proposal will not have an adverse effect upon surrounding properties.

**Recommended Conditions of Approval:**

*See Mitigation Measures, recommended Conditions of Approval, and mandatory Project Notes attached as Exhibit 1.*

**Conclusion:**

Finding 3 can be made.

*Finding 4:* *That the proposed development is consistent with the General Plan*

<b>Relevant Policies:</b>	<b>Consistency/Considerations:</b>
<p>General Plan Policy LU-A.3 allows agriculturally-related uses by discretionary permit, provided that they meet the following criteria:</p> <ul style="list-style-type: none"> <li>a. Criteria LU-A.3.a state that the use shall provide a needed service to the surrounding area which cannot be provided more effectively within urban areas or which requires location in a non-urban area because of unusual site requirements or operational characteristics.</li> <li>b. Criteria LU-A.3.b states that the use shall not be sited on productive agricultural land if less productive land is available in the vicinity.</li> </ul>	<p>Regarding Criteria “a”, currently there exist no agricultural commercial center consisting of a flea market in the project area to provide for the shopping needs of the local population. The project location in a remote area away from any urban development fits to the nature of proposed use. Regarding Criteria “b”, the project site is not a prime farmland. The site is a grazing land and not suited for farming. Regarding Criteria “c”, the limited water usage by the project will not significantly deplete groundwater or impact other water users within one quarter-mile radius. Alternatively, the project could be connected to a community water system, per the determination made by the State Water Resources Control Board, Division of Drinking Water. Regarding Criteria “d”, the nearby communities of Coalinga, Huron and others can provide a probable workforce.</p>

<b>Relevant Policies:</b>	<b>Consistency/Considerations:</b>
<p>c. Criteria LU-A.3.c states that the use shall not have a detrimental impact on water resources or the use or management of surrounding properties within at least one-quarter mile radius.</p> <p>d. Criteria LU-A.3.d states that a probable workforce should be located nearby or readily available.</p> <p>e. Criteria LU-A.3.e states that for proposed agricultural commercial center, the following criteria shall apply:</p> <ol style="list-style-type: none"> <li>1. Commercial uses should be clustered in centers instead of single uses.</li> <li>2. Commercial centers should be located a minimum of four (4) miles from any existing or approved agricultural or rural residential commercial center or designated commercial area of any city or unincorporated community.</li> <li>3. New commercial uses should be located within or adjacent to existing centers.</li> <li>4. Commercial centers should be located on a major road serving the surrounding area.</li> <li>5. Commercial centers should not encompass more than one quarter-mile of road frontage, or one-eighth of a mile if both sides of the road are involved, and should not provide potential for developments exceeding ten separate business activities, exclusive of caretakers' residences</li> </ol>	<p>Regarding Criteria “e” items 1 and 3, the proposed flea market operation is a cluster of retail uses involving buying and trading goods and supplies and requires a large piece of land to accommodate all activities at a single location. The dynamics of the project could not allow it to fit into an existing commercial center and there is no similar facility in the area the project could add to. Regarding item 2, the proposal is more than four miles away from any commercial uses in the area. Regarding Items 4 and 5, the project is located on a major thoroughfare (Jayne Avenue); will use 580 feet of road frontage which is less than one quarter-mile (1,320) of road frontage; involves less than ten separate business activities and includes no caretaker’s residence. The project is consistent with this policy.</p>
<p>General Plan Policy LU-A.13: County shall require buffers between proposed non-agricultural uses and adjacent agricultural operations.</p> <p>Policy LU-A.14 requires an assessment of the conversion of productive agricultural land and that mitigation shall be required where appropriate.</p>	<p>The project site is not a productive agricultural land. It is a grazing land suited to the grazing of livestock. Although, no farming operations exist adjacent to the project area, the proposed fencing around the flea market will separate the use from abutting land. The proposal is consistent with these policies.</p>
<p>General Plan Policy PF-C.17: County shall undertake a water supply evaluation, including determinations of water supply</p>	<p>Although the project site is in a water-short area of Fresno County, the Water and Natural Resources Division of the Fresno County Department of Public Works and</p>

<b>Relevant Policies:</b>	<b>Consistency/Considerations:</b>
adequacy, impact on other water users in the County, and water sustainability.	Planning expressed no concerns related to water supply to the project. As noted above, the project will use minimal water to be provided by an onsite well as a community water system or be connected to an existing public water system in the area as determined by the State Water Resources Control Board, Division of Drinking Water. The project is consistent with this policy.
General Plan Policy PF-D.6: County shall permit individual onsite sewage disposal systems on such parcels that have the area, soils, and other characteristics that permit installation of such disposal facilities without threatening surface or groundwater quality or posing any other health hazards and where community sewer service is not available and cannot be provided.	An individual sewage disposal system will be installed to serve the proposed restrooms. No concerns related to such system having an impact on groundwater quality were expressed by the Fresno County Department of Public Health, Environmental Health Division. The project is consistent with this policy.
Coalinga Regional Plan, Section 403-01:1.00. b: Westside Rangeland shall mean land designated for grazing and other agricultural operations, mining, oil and gas development, wildlife habitats, various recreational activities and other appropriate open-space functions.	The project site is a grazing land, and the proposed agricultural commercial center consisting of a flea market conforms to the uses allowed in the subject policy.

**Reviewing Agency Comments:**

Policy Planning Section of the Fresno County Department of Public Works and Planning: The property is designated Agriculture in the County General Plan. Policy LU-A.3 allows agriculturally-related uses by discretionary permit if they meet Criteria a - e. Policy LU-A.13 requires buffers between proposed non-agricultural uses and adjacent agricultural operations; and Policy LU-A.14 requires an assessment of the conversion of productive agricultural land. Policy PF-C.17 requires evaluation of adequacy and sustainability of the water supply for the project. Policy PF-D.6 requires individual onsite sewage disposal systems on parcels that have the area, soils, and other characteristics that permit installation of such disposal facilities without threatening surface or groundwater quality.

**Analysis:**

As discussed above in General Plan consistency/consideration, the proposed agricultural center consisting of a flea market meets the intent of Policy LU-A.3, Criteria a - e. The proposed facility involves selling and bartering of daily use goods and supplies and draws many vendors and patrons. For such a facility, a large isolated area away from urban areas is desirable. The project site fits the nature of the proposed use, as it is in a remote area away from any urban development. Although, the project site and the surrounding area is designated Agriculture in the County General Plan, the project site is a grazing land with limited farming activities in its vicinity. As required by Fresno County Department of Agriculture (Ag Commissioner’s Office),

the project will adhere to the Right-to-Farm Ordinance regarding the inconveniences and discomfort associated with normal farm activities surrounding the proposed development.

Regarding consistency with Policy LU-A.13 and LU-A.14, the project site is a grazing land suited to the grazing of livestock, and will be separated by fencing from the abutting lands which are not farmland. Regarding consistency with Policy PF-C.17, the project will utilize limited groundwater via an onsite well or be connected to an existing public water system. Regarding consistency with Policy PF-D.6, the project will install an individual sewage disposal system which will have no impact on groundwater quality.

Based on the above information, staff believes the proposal is consistent with the Fresno County General Plan.

**Recommended Conditions of Approval:**

*None.*

**Conclusion:**

Finding 4 can be made.

*Finding 5:* *That the conditions stated in the resolution are deemed necessary to protect the public health, safety and general welfare*

**Reviewing Agency Comments:**

Refer to **Reviewing Agency Comments** in Finding 3 of this report.

**Analysis:**

As discussed above in Finding 3, the project will comply with the Site Plan Review included as a Condition of Approval in the Resolution. This Condition was deemed necessary to ensure that project-related onsite and offsite improvements are constructed in a manner which protects public health, safety and general welfare. This includes the requirements that the access drives into the project site be provided with adequate width meeting the County road development standards, and site grading be performed according to the County Ordinance code to protect adjacent properties from flooding hazards. Additional requirements deemed necessary to protect public health, safety and general welfare, and included in the Resolution, require that outdoor lighting be hooded in order to minimize glare on adjacent roads/properties, onsite work be stopped and proper authorities be notified if cultural resources are unearthed during ground disturbance, onsite hazardous materials be handled per the State of California requirements, the public water system requirements be met prior to the project operation, a left-turn lane be constructed at patrons entrance into the project site, and a Traffic Management Plan be completed prior to the project operation.

**Recommended Conditions of Approval:**

*None.*

**Conclusion:**

Finding 5 can be made.

**PUBLIC COMMENT:**

*None.*

**CONCLUSION:**

Based on the factors cited in the analysis, staff believes the required Findings for granting the Classified Conditional Use Permit (CUP) can be made. Staff therefore recommends adoption of the Mitigated Negative Declaration prepared for the project and approval of Classified Conditional Use Permit No. 3632, subject to the recommended Conditions.

**PLANNING COMMISSION MOTIONS:**

**Recommended Motion** (Approval Action)

- Move to recommend adoption of the Mitigated Negative Declaration prepared for Initial Study Application No. 7568; and
- Move to recommend approval of the Master Plan prepared for the Agricultural Commercial Center; and
- Move to determine the required Findings can be made and move to recommend approval of Classified Conditional Use Permit No. 3632, subject to the Mitigation Measures, Conditions of Approval and Project Notes attached as Exhibit 1; and
- Direct the Secretary to prepare a Resolution documenting the Commission's action.

**Alternative Motion** (Denial Action)

- Move to determine that the required Findings cannot be made (state basis for not making the Findings) and move to deny Classified Conditional Use Permit No. 3632; and
- Direct the Secretary to prepare a Resolution documenting the Commission's action.

**Mitigation Measures, Recommended Conditions of Approval and Project Notes:**

See attached Exhibit 1.

EA:ksn  
G:\4360Devs&PIn\PROJSEC\PROJDOCS\CUP\3600-3699\3632\SR\CUP 3632 SR.docx



**Mitigation Monitoring and Reporting Program  
Initial Study Application No. 7568  
Classified Conditional Use Permit Application No. 3632**

<b>Mitigation Measures</b>					
<b>Mitigation Measure No.*</b>	<b>Impact</b>	<b>Mitigation Measure Language</b>	<b>Implementation Responsibility</b>	<b>Monitoring Responsibility</b>	<b>Time Span</b>
1.	Aesthetics	All outdoor lighting shall be hooded and directed downward so as to not shine toward adjacent properties and public streets.	Applicant	Applicant/Fresno County Department of Public Works and Planning (PW&P)	On-going; for duration of the project
2.	Air Quality	<p>Consistent with San Joaquin Valley Air Pollution Control District Regulation VIII (Fugitive PM10 Prohibitions), the following measures shall be implemented for dust control during grading and construction:</p> <ol style="list-style-type: none"> <li>1. The area disturbed by clearing, grading, earth moving, or excavation operations shall be minimized to prevent excessive amounts of dust.</li> <li>2. Pre-grading/excavation activities shall include watering the area to be graded or excavated before commencement of grading or excavating activities. Application of water should penetrate sufficiently to minimize fugitive dust during grading activities.</li> <li>3. Fugitive dust produced during grading, excavation, and construction activities shall be controlled by the following activities:               <ol style="list-style-type: none"> <li>a. All trucks shall be required to cover their loads as required by California Vehicle Code Section 23114.</li> <li>b. All graded and excavated material, exposed soil areas, and active portions of the construction site, including unpaved onsite roadways, shall be treated to prevent fugitive dust.</li> <li>c. Treatment shall include, but not necessarily be limited to, periodic watering, application of environmentally-safe soil stabilization materials, and/or roll compaction as</li> </ol> </li> </ol>	Applicant	Applicant/San Joaquin Valley Air Pollution Control District	As noted

**EXHIBIT 1**

		<p>appropriate. Watering shall be done as often as necessary by using reclaimed water whenever possible.</p> <p>4. Graded and/or excavated inactive areas of the construction site shall be monitored at least weekly for dust stabilization. Soil stabilization methods shall be periodically applied to portions of the construction site that are inactive for over four days. If no further grading or excavation operations are planned for the area within three weeks, it shall be seeded and watered until grass growth is evident, or periodically treated with environmentally-safe dust suppressants, to prevent excessive fugitive dust.</p> <p>5. Signs shall be posted on site, limiting traffic to 15 miles per hour or less.</p> <p>6. During periods of high winds, all clearing, grading, earth moving, and excavation operations shall be curtailed to the degree necessary to prevent fugitive dust from being an annoyance or hazard, either off site or on site.</p> <p>7. Adjacent streets and roads shall be swept at least once per day, preferably at the end of the day, if visible soil material is carried over to adjacent streets and roads.</p> <p>8. Personnel involved in grading operations, including contractors and subcontractors, shall wear respiratory protection in accordance with California Division of Occupational Safety and Health regulations.</p> <p>9. Rumble strips/shaker plates or base rock shall be installed at all truck exits from the site.</p> <p>10. Dust-control requirements shall be shown on all grading plans.</p>			
3.	Air Quality	<p>The following shall be implemented during construction to minimize emissions of ozone precursors:</p> <p>a. Construction contractors shall minimize equipment idling time throughout construction. Engines shall be turned off if idling would be for more than five minutes.</p> <p>b. Equipment engines shall be maintained in good condition and in proper tune as per manufacturers' specifications.</p>	Applicant	San Joaquin Valley Air Pollution Control District	As noted

		<p>c. The number of pieces of equipment operating simultaneously shall be minimized.</p> <p>d. Construction contractors shall use alternatively-fueled construction equipment (such as compressed natural gas, liquefied natural gas, or electric) when feasible.</p> <p>e. The engine size of construction equipment shall be the minimum practical size.</p> <p>f. Heavy-duty diesel-powered construction equipment manufactured after 1996 (with federally-mandated clean diesel engines) shall be utilized wherever feasible.</p> <p>g. During the smog season (May through October), the construction period should be lengthened.</p>			
4.	Biological Resources	A qualified biologist shall conduct a habitat assessment in advance of project implementation to determine if the project area or its immediate vicinity contains suitable habitat for San Joaquin kit fox (SJKF), assess presence/absence of SJKF by conducting surveys following the USFWS "Standardized Recommendations for Protection of SJKF Prior to or During Ground Disturbance" (2011), and upon SJKF detection, consult with CDFW to discuss how to avoid take, or if avoidance is not feasible, acquire an Incidental Take Permit (ITP) prior to the project activities, pursuant to Fish and Game Code Section 2081 (b).	Applicant	Applicant/ California Department of Fish and Wildlife (CDFW); U.S. Fish and Wildlife Service (USFWS)	As noted
5.	Biological Resources	A qualified biologist shall conduct a habitat assessment in advance of project implementation to determine if the Project area or its immediate vicinity contains suitable habitat for Blunt-nosed leopard lizard (BNLL). If suitable habitat is present, prior to initiating any project activities, conduct surveys in accordance with the "Approved Survey Methodology for the Blunt-nosed Leopard lizard" (CDFG 2004). Complete BNLL surveys no more than one year prior to initiation of ground disturbance. Protocol-level surveys must be conducted on multiple dates during late spring, summer, and fall, and that within these time periods there are specific protocol-level date, temperature, and time parameters which must be adhered to. If BNLL is detected during protocol level surveys, CDFW shall be consulted to discuss how to implement project activities and avoid take.	Applicant	Applicant/ CDFW/USFWS	As noted
6.	Biological Resources	A qualified biologist shall conduct a habitat assessment in advance of project implementation to determine if the project	Applicant	Applicant/ CDFW/USFWS	As noted

		<p>area or its immediate vicinity contains suitable habitat for San Joaquin Antelope Squirrel (SJAS). In areas of suitable habitat, a qualified biologist shall conduct focused daytime visual surveys for SJAS using line transects with 10- to 30-meter spacing. These surveys shall be conducted between April 1 and September 20, during daytime temperatures between 68-86° F (CDFG 1990). If suitable habitat is present and surveys or trapping are not feasible, a 50-foot minimum no-disturbance buffer shall be maintained around all small mammal burrows of suitable size for SJAS. If SJAS is detected, CDFW shall be consulted to discuss how to avoid take, or if avoidance is not feasible, to acquire an Incidental Take Permit (ITP) prior to ground-disturbing activities, pursuant to Fish and Game Code Section 2081 (b).</p>			
7.	Biological Resources	<p>A qualified wildlife biologist shall conduct surveys for nesting raptors following the survey methodology developed by the Swainson's Hawk (SWHA) Technical Advisory Committee (SWHA TAC 2000) prior to project initiation and assure that these surveys extend to a one half-mile radius surrounding the project area. If project activities take place during the normal bird breeding season (February 1 through September 15), additional pre-construction surveys for active nests shall be conducted by a qualified biologist no more than 10 days prior to the start of construction. If an active SWHA nest is found, a minimum one half-mile no-disturbance buffer shall be provided until the breeding season has ended or until a qualified biologist has determined that the birds have fledged and are no longer reliant upon the nest or parental care for survival. If SWHA are detected and the one half-mile no-disturbance nest buffer is not feasible, the California Department of Fish and Wildlife shall be consulted to determine if the project can avoid take. If SWHA cannot be avoided, an ITP prior to vegetation or ground-disturbing' activities is necessary to comply with the California Endangered Species Act.</p>	Applicant	Applicant/ CDFW/USFWS	As noted
8.	Biological Resources	<p>A qualified biologist shall conduct a habitat assessment in advance of project implementation to determine if the project area or its immediate vicinity contains suitable habitat for Giant Kangaroo Rat (GKR) and Short-nosed Kangaroo Rat (SNKR). If suitable habitat is present, a trapping plan for determining presence of GKR and SNKR shall be submitted to and approved by CDFW prior to subsequent trapping efforts. These surveys shall be conducted by a qualified biologist who holds a Memorandum of Understanding with the California Department of Fish and Wildlife (CDFW) for GKR and SNKR, and be conducted</p>	Applicant	Applicant/ CDFW/USFWS	As noted

		between April 1 and October 31, when kangaroo rats are most active. If suitable habitat is present and trapping is not feasible, a 50-foot minimum no-disturbance buffer shall be established around all small mammal burrows. If GKR or SNKR are found within the project area during pre-construction surveys or construction activities, CDFW shall be consulted to discuss how to implement the project and avoid take; or if avoidance is not feasible, to acquire an Incidental Take Permit for GKR prior to any ground-disturbing activities, pursuant Fish and Game Code Section 2081(b).			
9.	Biological Resources	The project site shall be surveyed for special-status plants by a qualified botanist following the "Protocols for Surveying and Evaluating Impacts to Special-Status Native Plant Populations and Sensitive Natural Communities" (CDFW 2018). In the absence of protocol-level surveys being performed, additional surveys may be necessary. The special-status plant species shall be avoided whenever possible by delineation and observing a no-disturbance buffer of at least 50 feet from the outer edge of the plant population(s) or specific habitat type(s) required by special-status plant species. If buffers cannot be maintained, then the California Department of Fish and Wildlife (CDFW) shall be consulted to determine appropriate minimization and mitigation measures for impacts to special-status plant species. If a California Endangered Species Act (CESA)-listed plant species is identified during botanical surveys, CDFW shall be consulted to determine if the project can avoid take. If take cannot be avoided, take authorization may be warranted. Take authorization would occur through issuance of an Incidental Take Permit by CDFW, pursuant to Fish and Game Code Section 2081(b).	Applicant	Applicant/ CDFW/USFWS	As noted
10.	Biological Resources	A qualified biologist shall conduct a habitat assessment in advance of project implementation, to determine if the project area or its vicinity contains suitable habitat for Burrowing Owl (BUOW). If suitable habitat is present on or in the vicinity of the project area, a qualified biologist shall conduct surveys following the California Burrowing Owl Consortium's (CBOC) "Burrowing Owl Survey Protocol and Mitigation Guidelines" (CBOC 1993) and CDFW's "Staff Report on Burrowing Owl Mitigation" (CDFG 2012). Three or more surveillance surveys shall be conducted during daylight with each visit occurring at least three weeks apart during the peak breeding season (April 15 to July 15), when BUOW are most detectable. In addition, the surveys shall include a 500-foot buffer around the Project area. No-disturbance buffers, as outlined in the "Staff Report on Burrowing Owl Mitigation" (CDFG 2012) shall be implemented prior to and during any ground-disturbing activities. Specifically, any impacts	Applicant	Applicant/ CDFW/USFWS	As noted

		to occupied burrows shall be avoided in accordance with the following table unless a qualified biologist approved by the California Department of Fish and Wildlife verifies through non-invasive methods that either: 1) the birds have not begun egg laying and incubation; or 2) that juveniles from the occupied burrows are foraging independently and are capable of independent survival.			
11.	Biological Resources	If Burrowing Owl (BUOW) are found within these recommended buffers and avoidance is not possible, burrow exclusion shall be conducted according to the Staff Report (CDFG 2012) by qualified biologists and only during the non-breeding season, before breeding behavior is exhibited and after the burrow is confirmed empty through non-invasive methods, such as surveillance. Also, occupied burrows shall be replaced with artificial burrows at a ratio of 1 burrow collapsed to 1 artificial burrow constructed (1:1) as mitigation for the potentially-significant impact of evicting BUOW.	Applicant	Applicant/ CDFW/USFWS	As noted
12.	Biological Resources	A qualified biologist shall conduct a habitat assessment in advance of project implementation, to determine if the project area or its immediate vicinity contain suitable habitat for Loggerhead shrike, LeConte's thrasher, American badger, San Joaquin coachwhip, western spadefoot, California legless lizard, California glossy snake, coast horned lizard, and American badger. If suitable habitat is present, a qualified biologist shall conduct focused surveys for applicable species and their requisite habitat features to evaluate potential impacts resulting from ground and vegetation disturbance. Avoidance whenever possible is encouraged via delineation and observance a 50-foot no-disturbance buffer around dens of mammals like the American badger as well as burrows which can provide refuge for small mammals, reptiles, and amphibians, and 100 feet around nests of special-status bird species.	Applicant	Applicant/ CDFW/USFWS	As noted
13.	Biological Resources	In addition to consultation with the California Department of Fish and Wildlife's (CDFW) Regional California Endangered Species Act staff, CDFW's Regional Ecological Reserve Management Unit staff shall also be consulted in advance of project initiation to demonstrate accurate delineation of property boundaries to prevent encroachment on CDFW-owned lands. Consultation is also recommended to discuss planned ingress and egress to the project area for the purposes of preventing encroachment on CDFW-owned lands. John Battistoni, Regional Ecological Reserve Management Unit Supervisor, shall be contacted via	Applicant	Applicant/ CDFW/USFWS	As noted

		email at John.Battistoni@wildlife.ca.gov. or via telephone at 559-243-4014 extension 219.			
14.	Biological Resources	<p>To mitigate impact to natural lands, the project proponent shall do the following:</p> <ul style="list-style-type: none"> <li>a. To mitigate for permanent impacts to natural lands by permanently conserving similar vegetation communities (grassland, saltbush scrub) that provide habitat for San Joaquin kit fox, San Joaquin antelope squirrel, and short-nosed kangaroo rat, provide one acre of mitigation land for each acre of development authorized.</li> <li>b. Permanently protect mitigation land through a conservation easement deeded to a nonprofit conservation organization or public agency with a conservation mission.</li> <li>c. Develop and implement a mitigation land management plan to address long-term ecological sustainability and maintenance of the site.</li> <li>d. Fund the maintenance and management of mitigation land by establishing a long-term funding mechanism such as an endowment.</li> <li>e. Mitigation lands shall be on, adjacent to, or near the Project site where possible.</li> <li>f. Where there is insufficient habitat on, adjacent to, or near the Project site, acquire mitigation lands with habitat for San Joaquin kit fox, San Joaquin antelope squirrel and short-nosed kangaroo rat away from the Project site.</li> <li>g. Alternatively, if the project site is within the service area of a California Department of Fish and Wildlife-approved conservation bank, purchase available conservation bank credits from that bank.</li> </ul>	Applicant	Applicant/ CDFW/USFWS	As noted
15.	Biological Resources	To protect brittlescale, crownscale, San Joaquin woollythreads, and recurved larkspur, a qualified biologist shall survey the project site during the flowering period (February–May for San Joaquin woollythreads and recurved larkspur; June–October for brittlescale; March–October for crownscale) for these species following the Protocols for Surveying and Evaluating Impacts to Special Status Plant Populations and Sensitive Natural Communities (CDFW 2018b). If any of these species is present,	Applicant	Applicant/ CDFW/USFWS	As noted

		the qualified biologist shall stake and flag no-disturbance exclusion zones of 100 feet around these plants prior to construction activities. These exclusion zones shall remain in place throughout construction activities. If these exclusion zones cannot be maintained, the project proponent shall consult with the CDFW to determine appropriate measures to implement to minimize or mitigate impacts to special-status plants.			
16.	Biological Resources	To protect San Joaquin coachwhip and California glossy snake, a qualified biologist shall conduct pre-construction surveys where suitable habitat is identified within proposed work areas immediately prior to ground-disturbing activities. If either species is found, work shall not begin until the animal has moved out of the work area on its own. During construction, a qualified biologist shall inspect open trenches, pits, and construction equipment and materials left on site for snakes each morning prior to the start of work and at the end of each workday.	Applicant	Applicant/ CDFW/USFWS	As noted
17.	Biological Resources	To protect blunt-nosed leopard lizard, a qualified biologist shall establish no-disturbance exclusion zones of 50 feet around all occupied or potentially-occupied burrows. A qualified biologist shall inspect open trenches for blunt-nosed leopard lizards each day prior to the start of work and at the end of each workday. If a blunt-nosed leopard lizard is found, all construction activities shall halt until it has moved out of the work area on its own. If ground-disturbing activities cannot avoid burrows, surveys following the methods described in Approved Survey Methodology for the Blunt-nosed Leopard Lizard (CDFG 2004) shall be conducted within one year of ground-disturbing activities to determine whether the species is present or absent. The results of these surveys shall be submitted to the California Department of Fish and Wildlife (CDFW). If a blunt-nosed leopard lizard is found at any time in the Project area, the project proponent shall consult with the CDFW to discuss how to implement the Project to avoid take.	Applicant	Applicant/ CDFW/USFWS	As noted
18.	Biological Resources	To protect Loggerhead shrike, construction shall be scheduled to avoid the nesting season, which extends from February through August. If it is not possible to schedule construction between September and January, pre-construction surveys for nesting birds shall be conducted by a qualified biologist to ensure that no active nests will be disturbed during Project implementation. A pre-construction survey shall be conducted no more than 14 days prior to the initiation of construction activities. During this survey, the qualified biologist shall inspect all potential nest substrates in and immediately adjacent to the impact areas for nests. If an	Applicant	Applicant/ CDFW/USFWS	As noted



		active nest is found close enough to the construction area to be disturbed by these activities, the qualified biologist shall determine the extent of a construction-free buffer to be established around the nest. If work cannot proceed without disturbing the nesting birds, work may need to be halted or redirected to other areas until nesting and fledging are completed, or the nest has otherwise failed for non-construction-related reasons.			
19.	Biological Resources	To protect San Joaquin antelope squirrel, a qualified biologist shall conduct pre-construction surveys for the species (Harris and Stearns 1991). If the species is detected near active work areas, the qualified biologist shall establish an exclusion zone of 50 feet around occupied or potentially-occupied burrows. If work must take place in the exclusion zone, the project proponent must consult with the California Department of Fish and Wildlife to determine if take can be avoided. If take cannot be avoided, an Incidental Take Permit pursuant to California Fish and Game Code Section 2081 must be obtained to comply with the California Endangered Species Act.	Applicant	Applicant/ CDFW/USFWS	As noted
20.	Biological Resources	To protect short-nosed kangaroo rat, a qualified biologist shall flag occupied or potentially-occupied burrows and establish 50-foot exclusion zones for avoidance. If these exclusion zones cannot be maintained, the project proponent shall consult with the California Department of Fish and Wildlife (CDFW) to determine appropriate measures to implement to minimize or mitigate impacts to short-nosed kangaroo rat.	Applicant	Applicant/ CDFW/USFWS	As noted
21.	Biological Resources	To protect American badger, a qualified biologist shall conduct a preconstruction survey for the species. If American badger or American badger activity (e.g., dens, diggings) are detected, the qualified biologist shall establish no-disturbance exclusion zones of 50 feet between active dens and the work area. If these exclusion zones cannot be maintained, the project proponent shall consult with the California Department of Fish and Wildlife to determine appropriate measures to implement to minimize or mitigate impacts to American badger.	Applicant	Applicant/ CDFW/USFWS	As noted
22.	Biological Resources	To protect San Joaquin kit fox, a qualified biologist shall conduct a preconstruction survey to identify potential dens, including potential atypical dens (i.e., manmade structures), in the Project area. If potential San Joaquin kit fox dens are present, their disturbance and destruction shall be avoided. If potential dens are located within the proposed work area and cannot be avoided during construction, a qualified biologist shall determine if the	Applicant	Applicant/ CDFW/USFWS	As noted

		dens are occupied following the U.S. Fish and Wildlife Service Standardized Recommendations for Protection of the Endangered San Joaquin Kit Fox Prior or During Ground Disturbance (USFWS 2011). If unoccupied, the qualified biologist will remove these dens by hand, excavating them in accordance with USFWS procedures (USFWS 2011). When occupied or potentially-occupied San Joaquin kit fox dens are adjacent to the work area, exclusion zones shall be implemented following USFWS procedures. Exclusion zones shall be determined based on the type of den and current use: Potential Den: 50 feet; Known Den: 100 feet; Natal or Pupping Den: to be determined on a case-by-case basis in coordination with USFWS and CDFW. All pipes greater than 4 inches in diameter stored on the construction site shall be capped and exit ramps shall be installed in trenches and other excavations to avoid direct mortality. When possible, construction shall be conducted from October 1 to November 30, outside of the breeding season. If occupied dens cannot be avoided, the project proponent shall consult with the U.S. Fish and Wildlife Service and California Department of Fish and Wildlife to determine whether Incidental Take Permits may be needed to comply with the Federal Endangered Species Act and California Endangered Species Act.			
23.	Biological Resources	The project proponent shall ensure that all activities related to the flea market operation remain within the limits of the project boundaries as shown on the approved Site Plan and must not encroach upon the 0.99 acre of potential waters/wetlands located within the outermost northwesterly corner of the project site as identified by Aquatic Resource Delineation Report prepared by Argonaut Ecological Consulting, Inc., and dated December 3, 2019.	Applicant	Applicant/ CDFW/USFWS	As noted
24.	Biological Resources	To the extent practicable, construction shall be scheduled to avoid the nesting season, which extends from February through August.	Applicant	Applicant/ CDFW/USFWS	As noted
25.	Biological Resources	If it is not possible to schedule construction between September and January, pre-construction surveys for nesting birds shall be conducted by a qualified biologist to ensure that no active nests will be disturbed during Project implementation. A pre-construction survey shall be conducted no more than 14 days prior to the initiation of construction activities. During this survey, the qualified biologist shall inspect all potential nest substrates in and immediately adjacent to the impact areas for nests. If an active nest is found close enough to the construction area to be	Applicant	Applicant/ CDFW/USFWS	As noted

		disturbed by these activities, the qualified biologist shall determine the extent of a construction-free buffer to be established around the nest. If work cannot proceed without disturbing the nesting birds, work may need to be halted or redirected to other areas until nesting and fledging are completed or the nest has otherwise failed for non-construction-related reasons.			
26.	Cultural Resources	In the event that cultural resources are unearthed during ground-disturbing activities, all work shall be halted in the area of the find. An Archeologist shall be called to evaluate the findings and make any necessary mitigation recommendations. If human remains are unearthed during ground-disturbing activities, no further disturbance is to occur until the Fresno County Sheriff-Coroner has made the necessary findings as to origin and disposition. All normal evidence procedures should be followed by photos, reports, video, etc. If such remains are determined to be Native American, the Sheriff-Coroner must notify the Native American Commission within 24 hours.	Applicant	Applicant/PW&P	As noted
27.	Hazards and Hazardous Materials	If buildings or other structures are to be demolished on any project sites included in the proposed project, prior to the issuance of building permits, surveys shall be conducted for the presence of lead-based paints or products, mercury, asbestos-containing materials, and polychlorinated biphenyl caulk. Removal, demolition and disposal of any of the above-mentioned chemicals shall be conducted in compliance with California environmental regulations and policies. In addition, sampling near current and/or former buildings shall be conducted in accordance with DTSC's 2006 Interim Guidance Evaluation of School Sites with Potential Contamination from Lead-Based Paint, Termiticides, and Electrical Transformers ( <a href="https://dtsc.ca.gov/wp-content/uploads/sites/31/2018/09/Guidance_Lead_Contamination_050118.pdf">https://dtsc.ca.gov/wp-content/uploads/sites/31/2018/09/Guidance_Lead_Contamination_050118.pdf</a> ).	Applicant	Applicant/ Department of Toxic Substances Control (DTSC)	As noted
28.	Hazards and Hazardous Materials	If any projects initiated as part of the proposed project require the importation of soil to backfill any excavated areas, prior to the issuance of building permits, proper sampling shall be conducted to ensure that the imported soil is free of contamination and the imported materials be characterized according to DTSC's 2001 Information Advisory Clean Imported Fill Material ( <a href="https://rfs-env.berkeley.edu/sites/default/files/dtscsmp_fs_cleanfill-schools.pdf">https://rfs-env.berkeley.edu/sites/default/files/dtscsmp_fs_cleanfill-schools.pdf</a> ).	Applicant	Applicant/DTSC	As noted

29.	Hazards and Hazardous Materials	If any sites included as part of the proposed project have been used for agricultural, weed abatement or related activities, prior to issuance of building permits, the current and former agricultural lands shall be evaluated in accordance with DTSC's 2008 Interim Guidance for Sampling Agricultural Properties (Third Revision) ( <a href="https://dtsc.ca.gov/wp-content/uploads/sites/31/2018/09/Ag-Guidance-Rev-3-August-7-2008-2.pdf">https://dtsc.ca.gov/wp-content/uploads/sites/31/2018/09/Ag-Guidance-Rev-3-August-7-2008-2.pdf</a> ).	Applicant	Applicant/DTSC	As noted
30.	Hydrology and Water Quality	Prior to the issuance of building permits and at the time of Site Plan Review for the proposed facility, the project proponent shall complete all water-related requirements for the project as required by and to the satisfaction of the State Water Resources Control Board (SWRCB), Division of Drinking Water (DDW). The project proponent shall also obtain permits from SWRCB-DDW prior to operating a public water system.	Applicant	Applicant/State Water Resources Control Board – Division of Drinking Water	As noted
31.	Transportation	Prior to occupancy being granted to the proposed facility, the project proponent shall obtain the necessary right-of-way, design and construct an eastbound left-turn lane of such length as recommended by a traffic engineer and approved by the County on Jayne Avenue into the patron access driveway, at the developer's expense. Additional pavement construction and dedication of road right-of-way to the County may be required for the widening of Jayne Avenue to accommodate the left-turn lane. Design documents and an encroachment permit application shall be submitted to the Road Maintenance and Operations Division for approval prior to construction.	Applicant	Applicant/PW&P	As noted
32.	Transportation	Should traffic impacts be observed for either the northbound or southbound off-ramp at the Interstate 5 and Jayne Avenue interchange, the project proponent shall prepare a Transportation Management Plan to alleviate such impacts. The plan, prior to its implementation, shall be reviewed and approved by the California Department of Transportation (Caltrans).	Applicant	Applicant/California Dept. of Transportation	As noted
33.	Transportation	Prior to the issuance of building permits, and at the time of Site Plan Review, the Applicant shall develop a Traffic Management Plan (TMP) for review and approval by the Road Maintenance and Operations Division of the Fresno County Department of Public Works and Planning. The TMP shall include a 220-foot-long driveway off Jayne Avenue as a queueing area, excluding visitor checkpoint/fee collection and the existing 60-foot right-of-way north of Jayne Avenue.	Applicant	Applicant/PW&P	As noted

<b>Conditions of Approval</b>	
1.	Development of the property shall be in accordance with the Site Plans, Elevations, and Operational Statement approved by the Planning Commission.
2.	Any public access to the parcel shall be provided with right- and left-turn lanes off Jayne Avenue, and be improved as part of the frontage improvements.
3.	The 220-foot-long public access driveway prior to entry into the visitor parking area shall be paved the entire 220-foot length and include a paved drive approach that ties into Jayne Avenue.
4.	The vendor access drive shall be paved for the first 100 feet and shall include a paved drive approach that ties into Jayne Avenue.
5.	Onsite signs shall indicate that vendor access is for vendors only and be restricted for use only during the set-up operations at the start of the day, and the tear-down operations at the end of the day. All other times during the day, traffic shall be confined to the patron entrance only.
6.	The patrons' parking and circulation areas shall be surfaced with base rock and be covered with either asphalt concrete grindings or road oil.
7.	The Applicant shall acknowledge the Fresno County Right-to-Farm Ordinance regarding the inconveniences and discomfort associated with normal farm activities surrounding the proposed development.

\*MITIGATION MEASURE – Measure specifically applied to the project to mitigate potential adverse environmental effects identified in the environmental document. Conditions of Approval reference recommended Conditions for the project.

<b>Notes</b>	
<b>The following Notes reference mandatory requirements of Fresno County or other Agencies and are provided as information to the project Applicant.</b>	
1.	This permit will become void unless there has been substantial development within two years of the effective date of this approval, or there has been a cessation of the use for a period in excess of two years.
2.	Prior to the issuance of building permits, a Site Plan Review shall be submitted to and approved by the Department of Public Works and Planning in accordance with Section 874 of the Fresno County Zoning Ordinance. Conditions of the Site Plan Review may include design of parking and circulation areas, access, onsite grading and drainage, right-of-way dedication, fire protection, landscaping, signage and lighting.
3.	Plans, permits and inspections are required for all onsite improvements. Contact the Building and Safety Section of the Fresno County Department of Public Works and Planning at (559) 600-4540 for permits and inspections.
4.	To address site development impacts resulting from the project, the Site Plan Review Unit of the Fresno County Department of Public Works and Planning requires the following: <ul style="list-style-type: none"> <li>• A dust palliative should be required on all unpaved parking and circulation areas.</li> </ul>

**Notes**

- Proposed driveways shall be a minimum of 24 feet and a maximum of 35 feet in width and be asphalt concrete paved as approved by the Road Maintenance and Operations Division.
- Parking spaces shall be constructed in compliance with the County and the state standards.
- All proposed signs shall be submitted to the Department of Public Works and Planning permits counter to verify compliance with the Zoning Ordinance.
- Proposed landscape improvement area of 500 square feet or more shall comply with California Code of Regulations Title 23, Division 2, Chapter 2.7 Model Water Efficient Landscape Ordinance (MWELO) and require submittal of Landscape and Irrigation plans per the Governor's Drought Executive Order of 2015.
- The Landscape and Irrigation plans shall be submitted to the Department of Public Works and Planning, Site Plan Review unit for review and approval prior to the issuance of Building Permits.

Note: These requirements will be addressed through Site Plan Review.

5.	<p>To address site development impacts resulting from the project, the Development Engineering Section of the Development Services and Capital Projects Division requires the following:</p> <ul style="list-style-type: none"><li>• An Engineered Grading and Drainage Plan and a grading permit</li><li>• An encroachment permit from Road Maintenance and Operations Division for any work done within the road right-of-way</li><li>• Accessible parking stalls shall be paved, and the path of travel shall be a hard surface per County codes.</li><li>• All storm water runoff shall be retained on site per County standards.</li><li>• A 30-foot by 30-foot corner cutoff for sight distance purposes shall be maintained at the proposed drive approaches into the site.</li><li>• Any proposed entrance gate shall be set back a minimum of 20 feet from the road right-of-way line or the length of the longest truck entering the site and shall not swing outward.</li></ul>
6.	<p>To address public health impacts resulting from the project, Fresno County Department of Public Health, Environmental Health Division (Health Department) requires the following:</p> <ul style="list-style-type: none"><li>• Onsite sewage disposal system shall be installed under permit and inspection by the Fresno County Department of Public Works and Planning, Building and Safety Section.</li><li>• If any underground storage tank(s) are found during construction, the Applicant shall apply for and secure an Underground Storage Tank Removal Permit from the Health Department.</li><li>• To protect groundwater, all abandoned water wells on the parcel shall be properly destroyed by an appropriately-licensed contractor.</li><li>• Prior to destruction of agricultural wells, a sample of the uppermost fluid in the well column shall be checked for lubricating oil.</li><li>• Should lubricating oil be found in the well, the oil shall be removed from the well prior to placement of fill material for destruction; and the "oily water" removed from the well must be handled in accordance with federal, state and local government requirements.</li></ul>
7.	<p>The project shall comply with California Code of Regulations Title 24 - Fire Code. Prior to receiving Fresno County Fire Protection District (FCFPD) conditions of approval for the subject application, plans must be submitted to the Fresno County Department of Public Works and Planning for review. It is the Applicant's responsibility to deliver a minimum of three sets of plans to FCFPD. In addition, the property shall annex to Community Facilities District (CFD) No. 2010-01 of FCFPD.</p>

<b>Notes</b>	
8.	The project shall adhere to the San Joaquin Valley Air Pollution Control District Regulation VIII (Fugitive PM10 Prohibitions); Rule 4601 (Architectural Coatings); Rule 4641 (Cutback, Slow Cure, and Emulsified Asphalt Paving and Maintenance Operations); Rule 4102 (Nuisance); and Rule 9510 (Indirect Source Review).
9.	Per the Mapping unit of the Fresno County Department of Public Works and Planning, prior to site development, all survey monumentation (Property Corners, Section Corners, County benchmarks, Federal benchmarks and triangulation stations) within the subject area shall be preserved in accordance with Section 8771 of the Professional Land Surveyors Act and Section 6730.2 of the Professional Engineers Act.

EA:ksn

G:\4360Devs&PIn\PROJSEC\PROJDOCS\CUP\3600-3699\3632\SR\CUP 3632 MMRP (Ex 1).docx

# LOCATION MAP

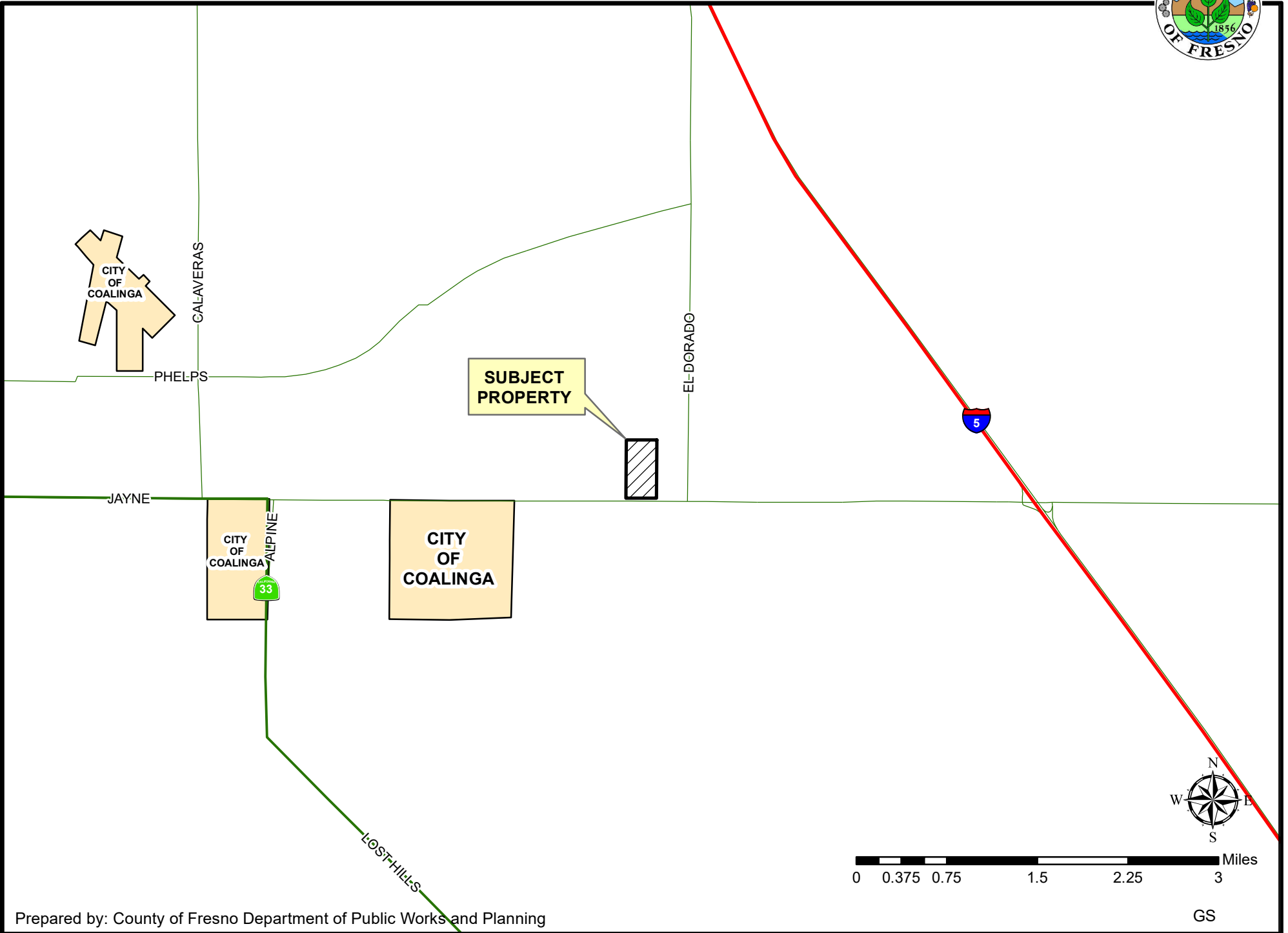



# EXISTING ZONING MAP

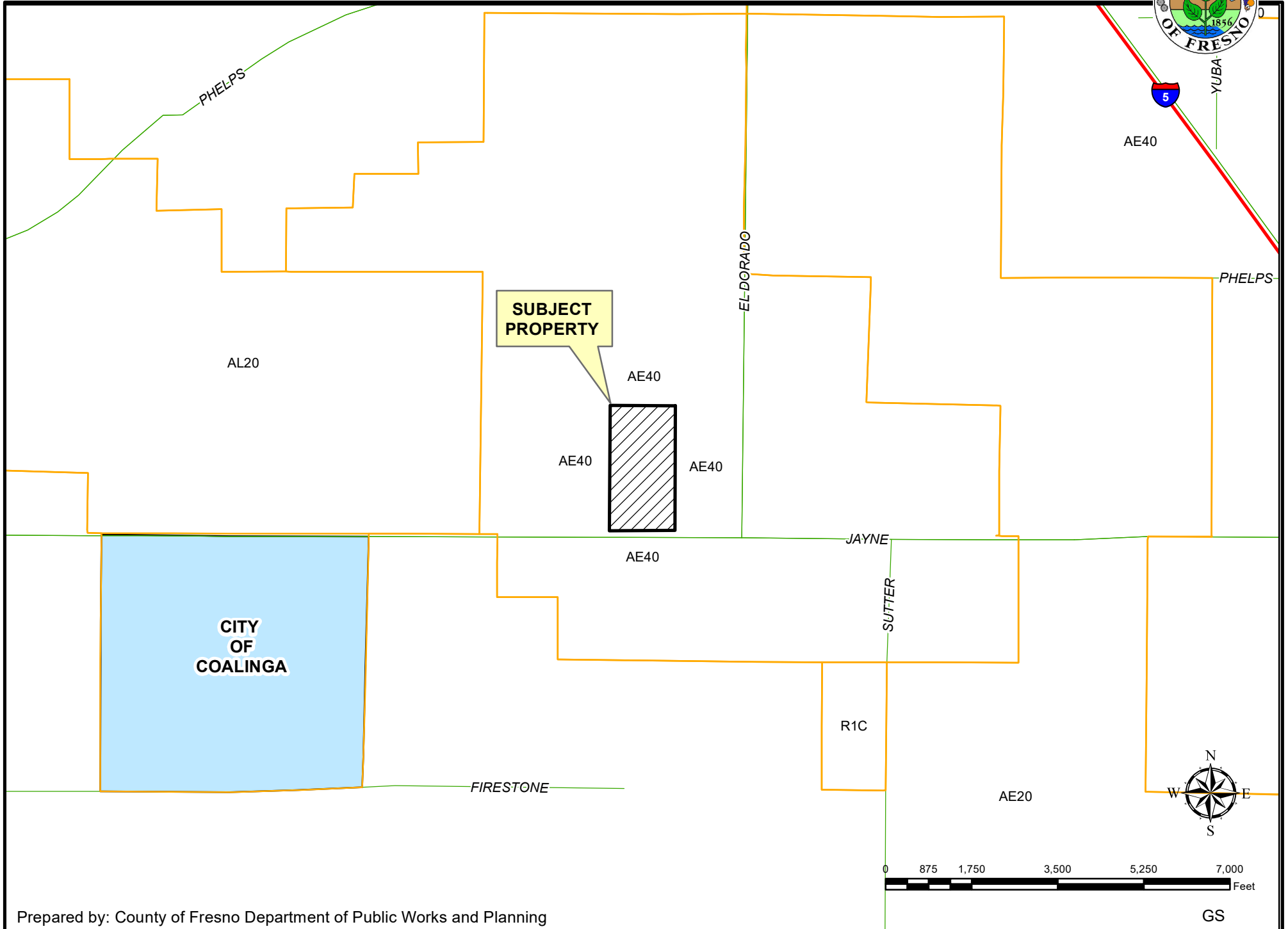

# EXISTING LAND USE MAP



LEGEND	
GRZ - GRAZING	
SF#- SINGLE FAMILY RESIDENCE	
V - VACANT	

LEGEND:

 Subject Property

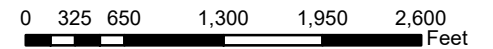
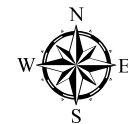

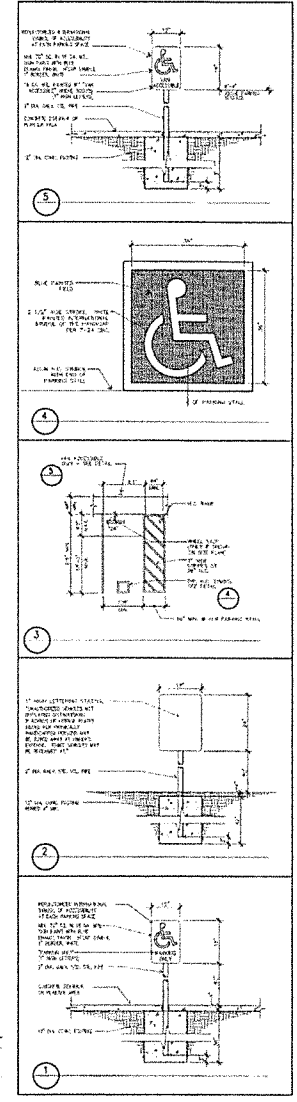
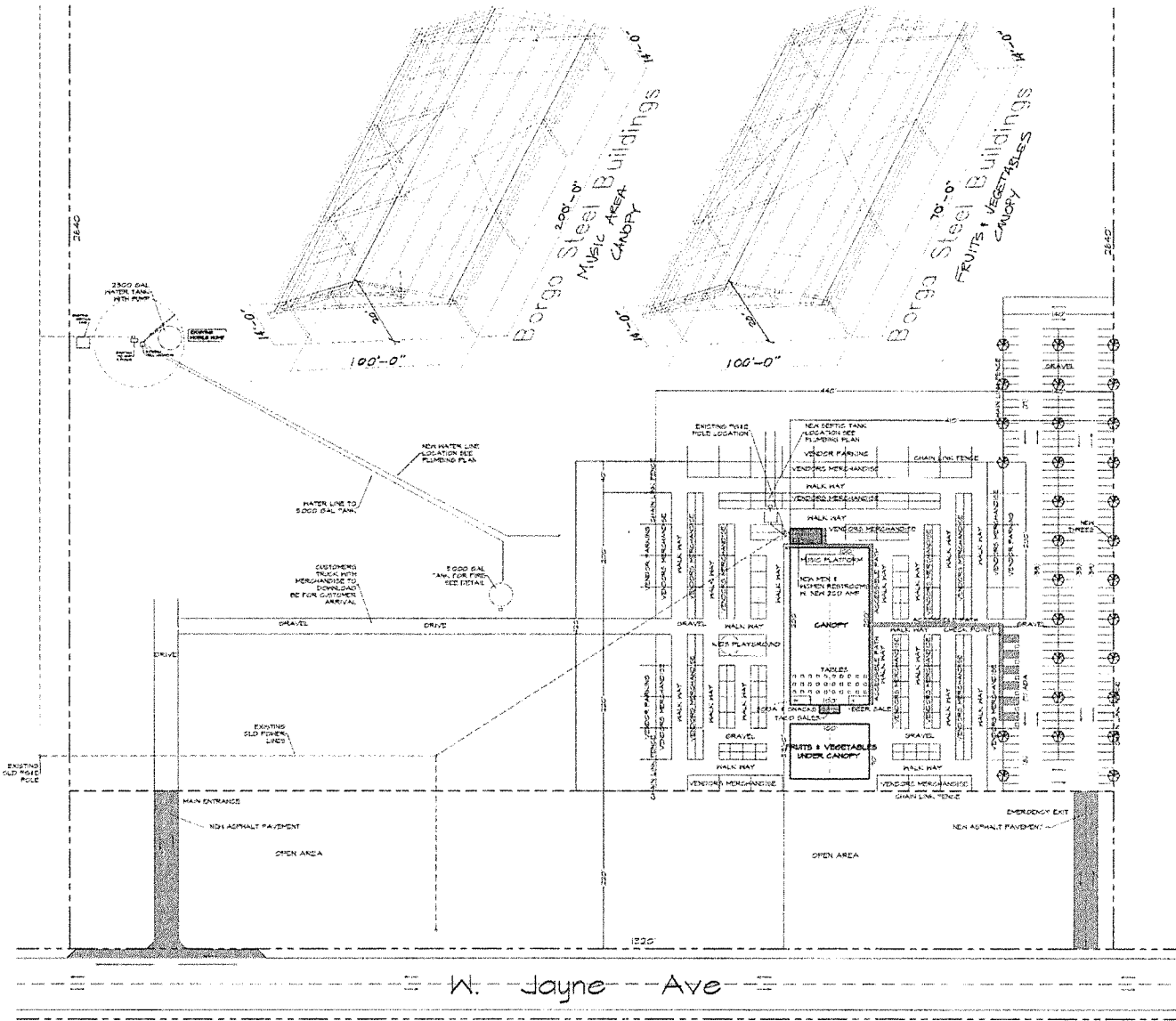

AGRICULTURAL COMMERCIAL CENTER MASTER PLAN

EXHIBIT 5



REVISIONS	BY

**SITE PLAN**

Proposed Flea Market For:  
**JOSE RITO GUTIERREZ**  
 38436 Joppe Ave  
 Coolidge, CA 95210

California Shine Construction  
 225 N. 10th St. Fresno, CA 93721  
 (509) 251-1000  
 www.californiashine.com  
 CA Lic. No. 95174-C  
 CA Lic. No. 95174-C-2022  
 California U.S. 104582

DRAWN	
CHECKED	
APP. PREPARED	
DATE	
SCALE	
AS NOTED	
JOB NO.	
SHEET	

A1

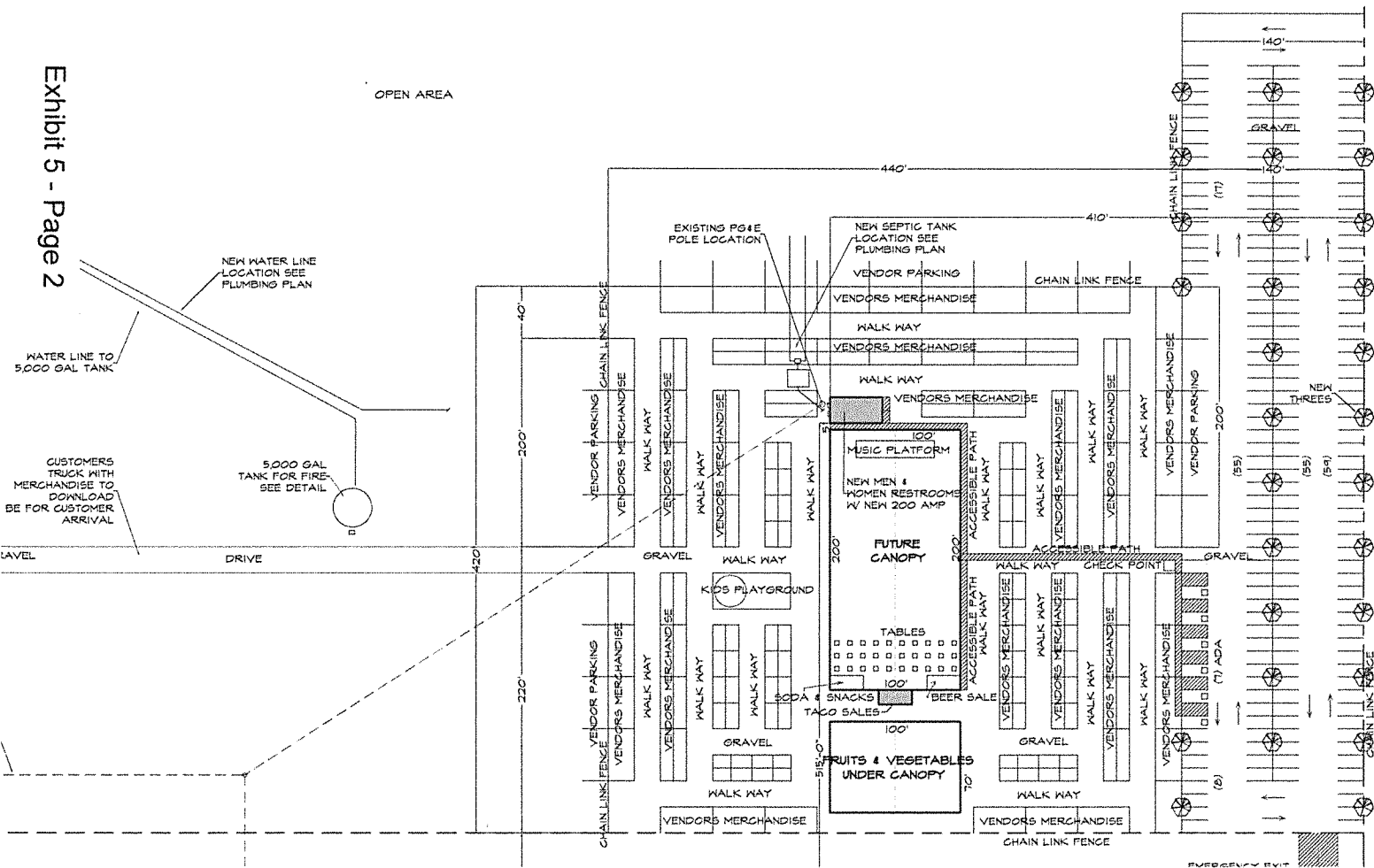

AGRICULTURAL COMMERCIAL CENTER MASTER PLAN (PARTIAL)

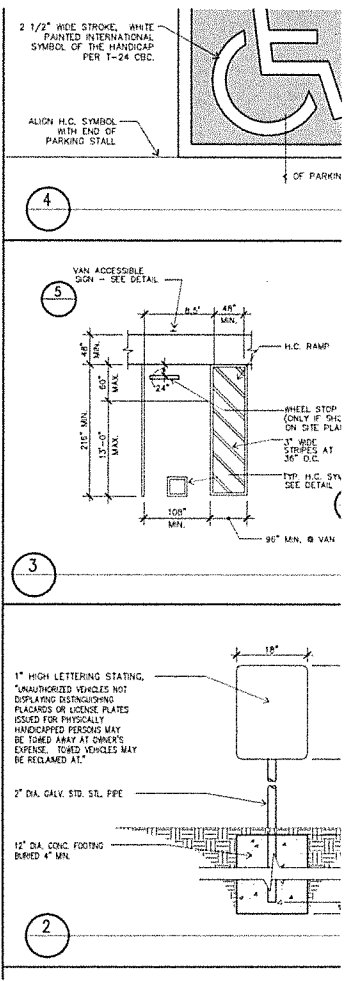

CUSTOMERS TRUCK WITH MERCHANDISE TO DOWNLOAD BE FOR CUSTOMER ARRIVAL

5,000 GAL TANK FOR FIRE - SEE DETAIL

NEW WATER LINE LOCATION SEE PLUMBING PLAN

WATER LINE TO 5000 GAL TANK

EXISTING PG&E POLE LOCATION

NEW SEPTIC TANK LOCATION SEE PLUMBING PLAN

2 1/2" WIDE STROKE, WHITE PAINTED INTERNATIONAL SYMBOL OF THE HANDICAP PER 1-24 CBC.

ALIGN H.C. SYMBOL WITH END OF PARKING STALL

5

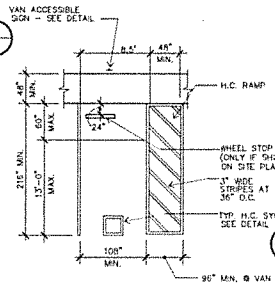

3

1" HIGH LETTERING STAGING. UNAUTHORIZED VEHICLES NOT DISPLAYING DISTINGUISHING PLACARDS OR LICENSE PLATES ISSUED FOR PHYSICALLY HANDICAPPED PERSONS MAY BE TOWED AWAY AT OWNER'S EXPENSE. TOWED VEHICLES MAY BE RECLAIMED AT...

2" DIA. GALV. STD. STL. PIPE

12" DIA. CONC. FOOTING BORED 4" MIN.

2

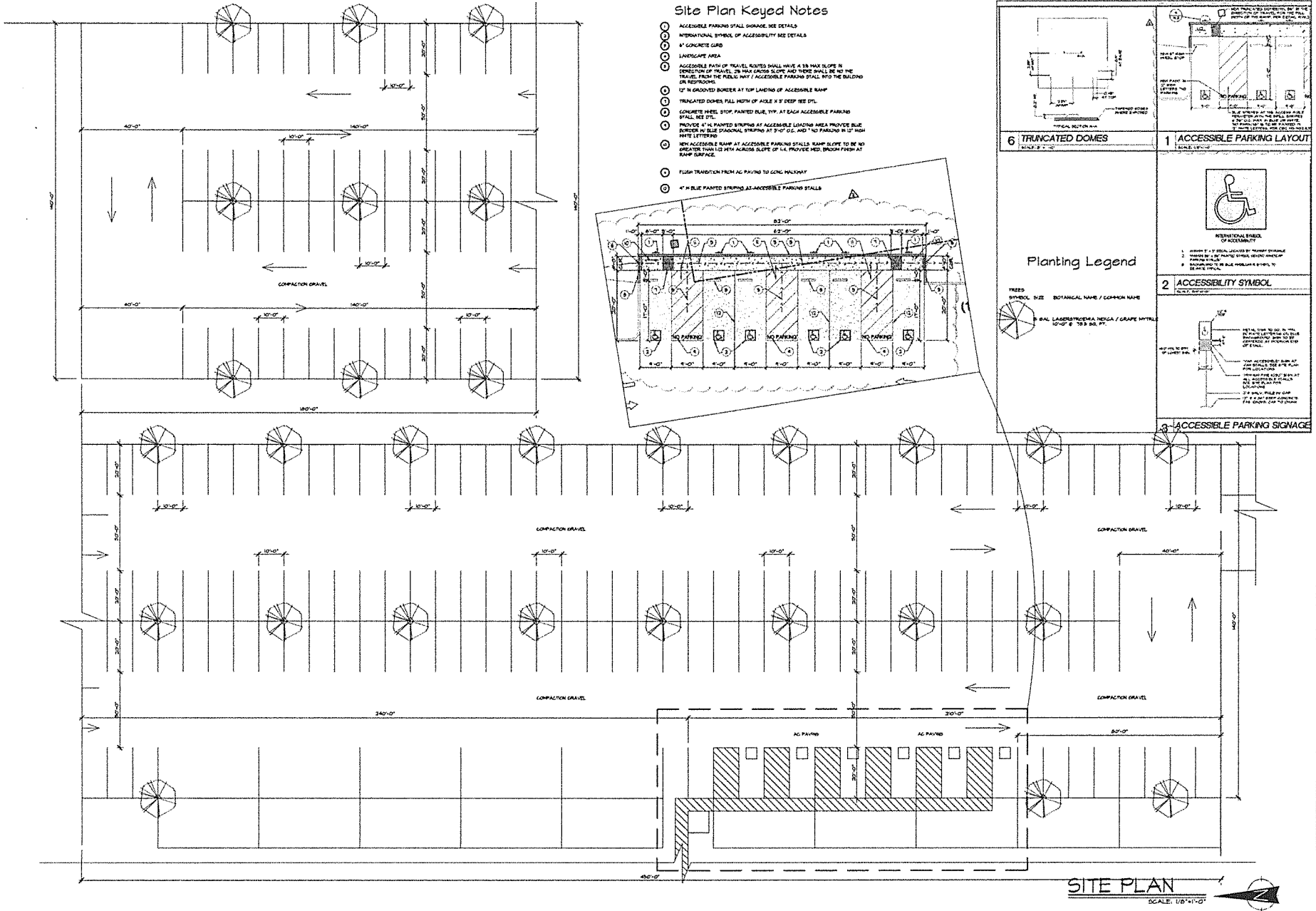

REVISIONS	BY

California Shine Construction  
 2511 N. 15th St., Suite 100, Redwood City, CA 94063  
 Phone: (650) 962-1100  
 Fax: (650) 962-1101  
 License No. C-45191  
 Licensee: John Shine, C-45191  
 Licensee: John Shine, C-45191

**PROPOSED SITE PLAN**

Proposed Flea Market For:  
**JOSE RITO GUTIERREZ**  
 29456 Joyce Ave  
 Covington, CA 95210

DRAWN  
 CHECKED  
 LUS DRAWN  
 DATE  
 01-20-18  
 SCALE  
 AS NOTED  
 JOB NO.  
 18-1845  
 SHEET  
**A.I.I**

AGRICULTURAL COMMERCIAL CENTER (PARKING LAYOUT)

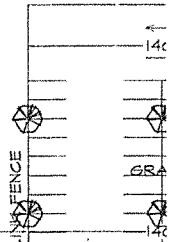
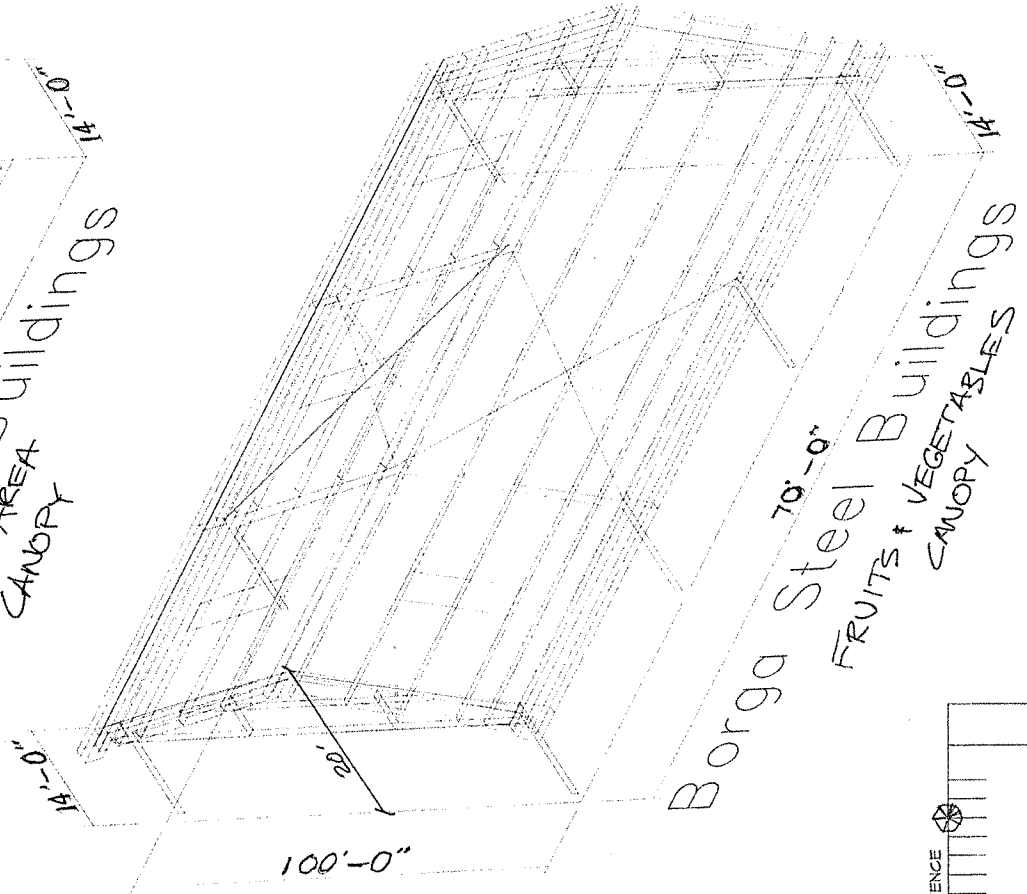
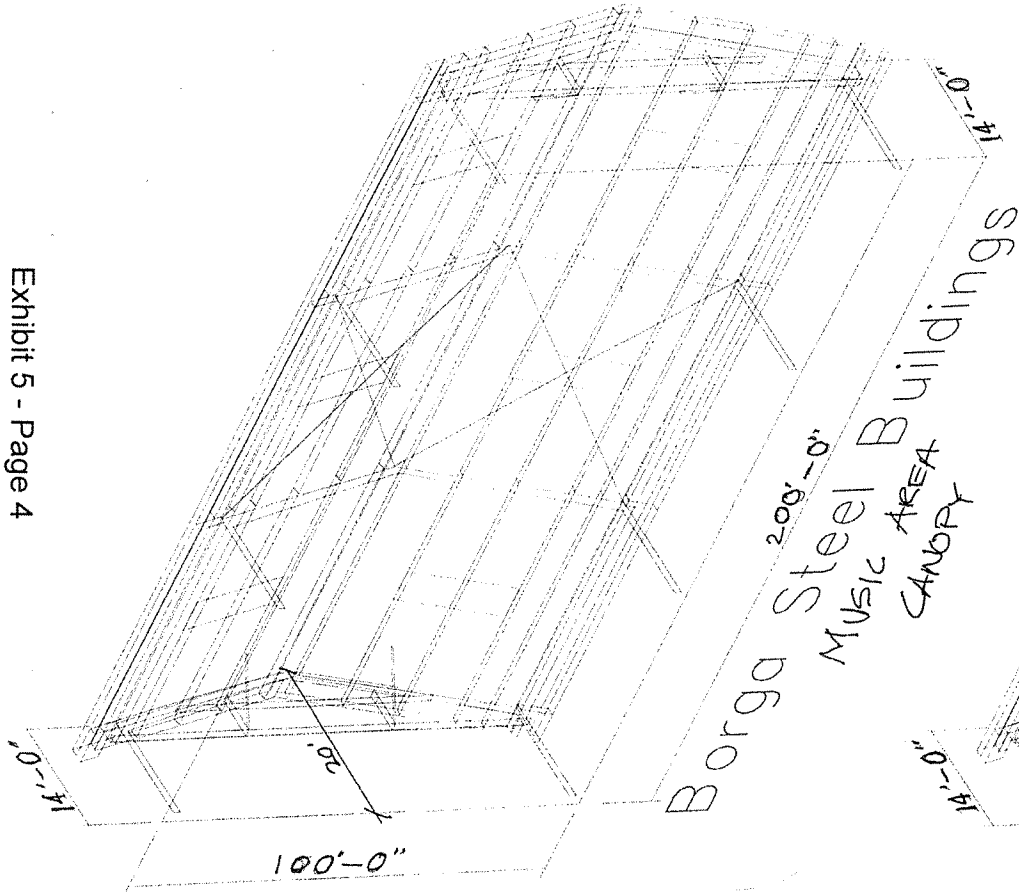

440

## EXHIBIT 6

Planning, community & Economic Development.

### PROJECT/BUSINESS OPERATIONAL STATEMENT

\*Applicant or Authorized Agent and contact information:

-Luis Bravo: Cellphone number (559) 999-1509 Office number (559) 41-7402

3251 N Marks Ave, Fresno CA 93722

[calshineconstruction@yahoo.com](mailto:calshineconstruction@yahoo.com)

[www.californiashineconstruction.net](http://www.californiashineconstruction.net)

\*Property Owner(s) and contact information:

-Gutierrez Properties LLC; 195 W Elm Ave. Coalinga CA, 93210

Cellphone number (559) 304-1889

\*Project/Business proposal/concept:

-Flea Market (swap meet)

\*Describe the project/ nature of operation:

-Rent, provide space to people who want to sell or barter merchandise, like used goods, cheap items, collectibles, antiques, Ect.

-Outdoor merchandise sales as in a field in a designated lot or under a tent provided by vendor itself.

-Sell food in custom food truck that will meet all county codes and standards, beer, snacks and soft drinks.

\*Identify the surrounding uses/business adjacent to the project/business:

-North: Agricultural

-South: Jayne Ave.

-East: Agricultural

-West: Agricultural

\*Project/business operations: (days and hours/evenings-weekends/indoor and/ or outdoor)

-Weekends only (Friday, Saturday and Sunday) outdoors from 5:00 am to 10:00 pm

\*Other special activities or events as part of this project/business: (temporary, permanent, frequency, hours, indoors or outdoors).

-None

\*Estimated number of visitors (customers, patrons, members).

-500

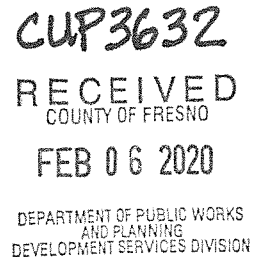

\*Number of employees: (By shift, time of day, year, etc.)

-5

\*Service and delivery vehicles including company/business vehicles (specify type and number).

-Small cargo vans with merchandise from sellers, guessing hopefully 100 vendors

\*Number of parking spaces proposed and/ or existing on the site/property.

-201

\*Are any goods to be sold/ packaged/manufactured on the site/property (retail and/ or wholesale)?

-No

\*What type of equipment, supplies and/ or materials will be used, kept and/ or stored for the project/business?

-None

\*How will access be provided to the project/business (street, highways, rail)?

- Compacted dirt with overlay or grinded gravel to prevent dust.

\*Estimate the number and type of trips per day generated by the project (cars, trucks, rail).

-100

\*Will the project/ business and its use cause any unsightly appearance or create a public nuisance?

-No

\*Will the project/business and its use cause or create any noise, glare, dust, smoke or odors?

-No

\*Estimated volume of water to be used daily. Any water recycling planned or proposed?

-300 Gallons, water will be provided from an existing well in good condition.

\*Estimated volume of garbage/trash (solid waste) generated by the use and type of solid waste produced from the project/business. How will waste be stored on the premises and what type of solid waste enclosure will be constructed or provided?

-Garbage and recycling bins will be provided permanently in a garbage enclosure.

\*Will the project/business produce any hazardous materials/waste? If so, will they be shipped or stored? How will they be handled? How will they be disposed of?

-None

\*Describe the type of outdoor advertising signage needed. (type of signs, design, height, length and placement).



-4' x 8' sign in front of Flea Market entrance.

\*Will the project/business include the construction of a new building or structure? Which buildings or what portion of the buildings will be used in the operation?

-Men and Women ADA restrooms: 70'x100' and 100'x200' canopies

\*Will any existing or new outdoor lighting or outdoor sound amplification system be used?

-New 200 AMP 3 phase 120-240 breaker panel for outdoor lighting.

-Temporary shelters, canopies, shades will be provided by vendors.

\*Will the project/business install new landscaping/irrigation, fencing and walls? (Describe type, design and locations)

-Security fence surrounding Flea Market and proposed green area at front of Jayne Ave.

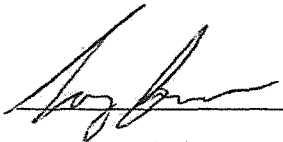
 02-06-2020

Luis Bravo (Authorized Agent)



# County of Fresno

DEPARTMENT OF PUBLIC WORKS AND PLANNING  
STEVEN E. WHITE, DIRECTOR

## EVALUATION OF ENVIRONMENTAL IMPACTS

- APPLICANT: Luis Bravo on behalf of Rito Gutierrez
- APPLICATION NOS.: Initial Study Application No. 7568 and Classified Conditional Use Permit Application No. 3632
- DESCRIPTION: Allow an agricultural commercial center consisting of an approximately 6-acre flea market with related improvements on a 78.18-acre parcel in AE-40 (Exclusive Agricultural, 40-acre minimum parcel size) Zone District.
- LOCATION: The project is located on the north side of W. Jayne Avenue approximately 2,556 feet west of its intersection with El Dorado Avenue and 6.4 miles east of the nearest city limits of City of Coalinga (23436 W. Jayne Avenue, Coalinga) (Sup. Dist. 4) (APN 073-090-20S).

### I. AESTHETICS

Except as provided in Public Resources Code Section 21099, would the project:

- A. Have a substantial adverse effect on a scenic vista; or
- B. Substantially damage scenic resources, including, but not limited to, trees, rock outcroppings, and historic buildings within a state scenic highway?

FINDING: NO IMPACT:

The project site is a grazing land located near the City of Coalinga. Surrounding the site are grazing lands and sparse agricultural fields. Jane Avenue borders the site and is not designated as a scenic highway in the County General Plan. There are no scenic vistas or scenic resources, including trees, rock outcroppings, or historic buildings, on or near the site that will be impacted by the subject proposal. The project will have no impact on scenic resources.

- C. In non-urbanized areas, substantially degrade the existing visual character or quality of public views of the site and its surroundings? (Public views are those that are experienced from publicly accessible vantage points.) If the project is in an urbanized area, would the project conflict with applicable zoning and other regulations governing scenic quality?

FINDING: LESS THAN SIGNIFICANT IMPACT:

The project site is surrounded by grazing lands. Most agricultural fields with farming operations are located approximately 1.5 miles to the east and sparse agricultural fields are located to the south and west of the project site.

The proposed improvements related to the project include vendors' stalls, restrooms, music platform/sitting area under canopy, fruit/vegetable stalls under canopy, and parking for vendors and patrons. Except for the restroom building and canopies, vendors' stalls can be removed at the end of business day. The project area is rural in nature. Given the proposed improvements (including restroom building and canopies) are low height and will be set back more than 220 feet from Jayne Avenue (public road), 2,000 feet from the nearest residential development to the east, and 0.8 mile from Coalinga State Hospital to the west, the project's visual impact on the area would be less than significant.

- D. Create a new source of substantial light or glare which would adversely affect day or nighttime views in the area?

FINDING: LESS THAN SIGNIFICANT IMPACT WITH MITIGATION INCORPORATED:

Per the Applicant's Operational Statement, outdoor lighting will be used to illuminate the flea market after sunset. To reduce any lighting and glare impact resulting from the project, a Mitigation Measure would require that all outdoor lighting shall be hooded and directed as to not shine toward adjacent properties and public streets.

\* **Mitigation Measure**

1. *All outdoor lighting shall be hooded and directed so as not to shine toward adjacent properties and public streets.*

As noted above, there are a sporadic improvement located in the project vicinity at significant distance. As such, any impact resulting from automobile headlights shining on those improvements is expected to be less than significant.

II. AGRICULTURAL AND FORESTRY RESOURCES

In determining whether impacts to agricultural resources are significant environmental effects, lead agencies may refer to the California Agricultural Land Evaluation and Site Assessment Model (1997) prepared by the California Department of Conservation as an optional model to use in assessing impacts on agriculture and farmland. In determining whether impacts to forest resources, including timberland, are significant environmental effects, lead agencies may refer to information compiled by the California Department of Forestry and Fire Protection regarding the state's inventory of forest land, including the Forest and Range Assessment Project and the Forest Legacy Assessment project; and forest carbon measurement methodology in Forest Protocols adopted by the California Air Resources Board. Would the project:

- A. Convert Prime Farmland, Unique Farmland, or Farmland of Statewide Importance, as shown on the maps prepared pursuant to the Farmland Mapping and Monitoring Program of the California Resources Agency, to non-agricultural use?

FINDING: NO IMPACT:

The project site is classified as Grazing Land on the 2016 Fresno County Important Farmland Map suited to the grazing of livestock. The site is not an agricultural land. Therefore, no individual or cumulative loss to agricultural land would occur from this proposal.

- B. Conflict with existing zoning for agricultural use, or a Williamson Act Contract?

FINDING: NO IMPACT:

The subject proposal is not in conflict with the existing AE-40 (Exclusive Agricultural, 40-acre minimum parcel size) zoning on the property and is an allowed use on land designated for agriculture with discretionary approval and adherence to the applicable General Plan Policies. The project site is not enrolled in the Williamson Act Program.

- C. Conflict with existing zoning for forest land, timberland or timberland zoned Timberland Production; or
- D. Result in the loss of forest land or conversion of forest land to non-forest use; or
- E. Involve other changes in the existing environment, which, due to their location or nature, could result in conversion of farmland to non-agricultural use or conversion of forestland to non-forest use?

FINDING: LESS THAN SIGNIFICANT IMPACT:

The project site is not forestland or timberland. Zoned AE-40 (Exclusive Agriculture) in the County Ordinance, the site is a grazing land suited to the grazing of livestock. The project will be established on a non-agricultural land and will not set a precedent for conversion of active farmland in the area to non-agricultural uses.

This project was routed to the Fresno County Agricultural Commissioner's Office for review and comments. Per the comments provided, a Condition of Approval for the project would require that the Applicant shall acknowledge the Fresno County Right-to-Farm Ordinance regarding the inconveniences and discomfort associated with normal farm activities surrounding the proposed development.

### III. AIR QUALITY

Where available, the significance criteria established by the applicable air quality management district or air pollution control district may be relied upon to make the following determinations. Would the project:

A. Conflict with or obstruct implementation of the applicable Air Quality Plan?

FINDING: LESS THAN SIGNIFICANT IMPACT:

The Air Quality Plan (AQP) contains several control measures that are enforceable requirements through the adoption of rules and regulations. The following San Joaquin Valley Air Pollution Control District rules and regulations may apply during buildout of the project, including, but not limited to: Regulation VIII (Fugitive PM<sub>10</sub> Prohibitions); Rule 4601 (Architectural Coatings); Rule 4641 (Cutback, Slow Cure, and Emulsified Asphalt, Paving and Maintenance Operations); Rule 4102 (Nuisance); and Rule 9510 (Indirect Source Review).

The project would comply with all applicable Air Resources Board (ARB) and San Joaquin Valley Air Pollution Control District rules and regulations as noted above and would not conflict with or obstruct implementation of the applicable air quality attainment plan as discussed below in Section III. B. The project's emissions (short-term construction and long-term operational emissions) would be less than significant for all criteria pollutants. The project complies with all applicable rules and regulations from the applicable Air Quality Plan (APQ); therefore, the project is not considered inconsistent with the AQP, and the impact would be less than significant.

B. Result in a cumulatively considerable net increase of any criteria pollutant for which the project region is non-attainment under an applicable federal or state ambient air quality standard?

FINDING: LESS THAN SIGNIFICANT IMPACT WITH MITIGATION INCORPORATED:

The applicant provided an Air Quality Analysis, completed by Vans Inc. Consulting Engineers (VICE), dated December 16, 2019. The Analysis was provided to the San Joaquin Valley Air Pollution Control District (SJVAPCD) along with the project information for review and comments. No concerns were expressed by the District.

The proposed project's construction and operations would contribute the following criteria pollutant emissions: reactive organic gases (ROG), carbon monoxide (CO), nitrogen dioxide (NO<sub>2</sub>), and particulate matter (PM<sub>10</sub> and PM<sub>2.5</sub>). The project does not contain sources that would produce substantial quantities of sulfur dioxide (SO<sub>2</sub>) emissions during construction and operation. Criteria and Greenhouse Gas (GHG) emissions were estimated using the California Emissions Estimator Model (CalEEMod) version 2016.3.2 [California Air Pollution Control Officers Association (CAPCOA) 2017], which is the most current version of the model approved for use by SJVAPCD.

The San Joaquin Valley Air Pollution Control District's annual emission significance thresholds used for the project define the substantial contribution for both construction and operational emissions as follows: 100 tons per year CO, 10 tons per year NO<sub>x</sub>, 10 tons per year ROG, 27 tons per year SO<sub>x</sub>, 15 tons per year PM<sub>10</sub>, and 15 tons per year PM<sub>2.5</sub>.

Per the Air Quality Analysis, construction emissions associated with the project from each year of construction activities (year 2020 and 2021) will be 0.3959 ton per year CO, 0.06807 ton per year NO<sub>x</sub>, 0.1202 ton per year ROG, 0.0859 ton per year PM<sub>10</sub>, and 0.0537 ton per year PM<sub>2.5</sub>. Per the results, the project construction emissions would be below the SJVAPCD threshold of significance. In addition to the construction period thresholds of significance, implementation of the following Mitigation Measures would ensure that the proposed project complies with Regulation VIII to further reduce the short-term construction period air quality impacts.

\* **Mitigation Measures**

*Consistent with San Joaquin Valley Air Pollution Control District Regulation VIII (Fugitive PM<sub>10</sub> Prohibitions), the following measures shall be implemented for dust control during grading and construction:*

- 1. The area disturbed by clearing, grading, earth moving, or excavation operations shall be minimized to prevent excessive amounts of dust.*
- 2. Pre-grading/excavation activities shall include watering the area to be graded or excavated before commencement of grading or excavating activities. Application of water should penetrate sufficiently to minimize fugitive dust during grading activities.*
- 3. Fugitive dust produced during grading, excavation, and construction activities shall be controlled by the following activities:*
  - a. All trucks shall be required to cover their loads as required by California Vehicle Code Section 23114.*
  - b. All graded and excavated material, exposed soil areas, and active portions of the construction site, including unpaved on-site roadways, shall be treated to prevent fugitive dust.*
  - c. Treatment shall include, but not necessarily be limited to, periodic watering, application of environmentally-safe soil stabilization materials, and/or roll compaction as appropriate. Watering shall be done as often as necessary by using reclaimed water whenever possible.*
- 4. Graded and/or excavated inactive areas of the construction site shall be monitored at least weekly for dust stabilization. Soil stabilization methods shall be periodically applied to portions of the construction site that are inactive for over four days. If no further grading or excavation operations are planned for the area within three weeks, it shall be seeded and watered until grass growth is evident, or periodically treated with environmentally-safe dust suppressants, to prevent excessive fugitive dust.*
- 5. Signs shall be posted on site limiting traffic to 15 miles per hour or less.*

6. *During periods of high winds, all clearing, grading, earth moving, and excavation operations shall be curtailed to the degree necessary to prevent fugitive dust from being an annoyance or hazard, either off site or on site.*
7. *Adjacent streets and roads shall be swept at least once per day, preferably at the end of the day, if visible soil material is carried over to those adjacent streets and roads.*
8. *Personnel involved in grading operations, including contractors and subcontractors, shall wear respiratory protection in accordance with California Division of Occupational Safety and Health regulations.*
9. *Rumble strips/shaker plates/or base rock shall be installed at all truck exits from the site.*
10. *Dust control requirements shall be shown on all grading plans.*
11. *The following shall be implemented during construction to minimize emissions of ozone precursors.*
  - a. *Construction contractors shall minimize equipment idling time throughout construction. Engines shall be turned off if idling would be for more than five minutes.*
  - b. *Equipment engines shall be maintained in good condition and in proper tune as per manufacturers' specifications.*
  - c. *The number of pieces of equipment operating simultaneously shall be minimized.*
  - d. *Construction contractors shall use alternatively-fueled construction equipment (such as compressed natural gas, liquefied natural gas, or electric) when feasible.*
  - e. *The engine size of construction equipment shall be the minimum practical size.*
  - f. *Heavy-duty diesel-powered construction equipment manufactured after 1996 (with federally-mandated clean diesel engines) shall be utilized wherever feasible.*
  - g. *During the smog season (May through October), the construction period should be lengthened*

Operational emissions occur over the lifetime of the project from two main sources: area sources and motor vehicles, or mobile sources. Per the Air Quality Analysis, operational emissions associated with the project will be as follows: 0.7573 ton per year CO, 0.0766 ton per year NO<sub>x</sub>, 0.0883 ton per year ROG, 0.1818 ton per year PM<sub>10</sub>, and

0.0490 ton per year PM<sub>2.5</sub>. Per the results, the project's operational emissions would be below the SJVAPCD threshold of significance: 100 tons per year CO, 10 tons per year NO<sub>x</sub>, 10 tons per year ROG, 27 tons per year SO<sub>x</sub>, 15 tons per year PM<sub>10</sub>, and 15 tons per year PM<sub>2.5</sub>.

Per the above-discussed regional analysis of construction and operational emissions, the project would not exceed the District's significance thresholds and is consistent with the applicable Air Quality Attainment Plan. Therefore, the project would not result in significant cumulative health impacts.

C. Expose sensitive receptors to substantial pollutant concentrations?

FINDING: LESS THAN SIGNIFICANT IMPACT:

Those who are sensitive to air pollution include children, the elderly, and persons with preexisting respiratory or cardiovascular illness. A sensitive receptor is considered a location that houses or attracts children, the elderly, people with illnesses, or others who are especially sensitive to the effects of air pollutants. This includes hospitals, residences, convalescent facilities, and schools. The closest sensitive receptor, a residential dwelling, is approximately one half-mile east of the project site.

Emissions occurring at or near the project have the potential to create a localized impact, also referred to as an air pollutant hotspot. Localized emissions are considered significant if when combined with background emissions they would result in exceedance of any health-based air quality standard. The criteria pollutants of concern for localized impact in the San Joaquin Valley Air Basin (SJVAB) are PM<sub>10</sub>, PM<sub>2.5</sub>, NO<sub>2</sub>, and CO.

Per the Air Quality Analysis Maximum Daily Air Pollutant Emissions, the screening threshold is 100 for NO<sub>x</sub>, CO, PM<sub>10</sub> and PM<sub>2.5</sub>. An analysis of maximum daily pollutant emissions during construction and operation was conducted to determine if emissions would exceed 100 pounds per day for any pollutant of concern. Per the Analysis, the maximum daily emission during construction would be as follows: 28.85 NO<sub>x</sub>, 22.337 CO, 6.9921 PM<sub>10</sub> and 4.3719 PM<sub>2.5</sub>, and the maximum daily emission during operation would be 0.4610 NO<sub>x</sub>, 4.6773 CO, 1.0262 PM<sub>10</sub> and 0.2761 PM<sub>2.5</sub>. Given the results, the project emissions would not exceed the significance thresholds, and therefore, the project's air quality impacts are less than significant.

Per the Air Quality Analysis, the project emissions may be considered significant if a Carbon Monoxide Hotspot Analysis determines that the project-generated emissions cause a localized violation of the state CO one-hour standard of 20 ppm, the state CO 8-hour standard of 9.0 ppm, the federal CO one-hour standard of 35 ppm, or the federal CO 8-hour standard of 9 ppm. Increased CO concentrations usually are associated with roadways that are congested and with heavy traffic volume. Per SJVAPCD, a project can be said to have no potential to create a violation of the CO standard if the Level of Service (LOS) on one or more streets or intersections in the project vicinity will not be reduced to LOS E or F; or the project will not substantially worsen an already existing LOS F on one or more streets or intersections in the project vicinity.



The construction of the project would result in minor increases in traffic for the surrounding road network during the duration of construction. Motor vehicles accessing the site when it becomes operational would result in a minor increase in daily trips that would not substantially reduce the LOS. Also, local roadways are not identified as operating at unacceptable conditions under existing and future buildout conditions.

Furthermore, the highest background 8-hour average of carbon monoxide is 1.61 ppm (parts per million), which is 82 percent lower than the state ambient air quality standard of 9.0 ppm. Therefore, the project would not significantly contribute to an exceedance of state or federal CO standards. As such, less than significant health risk would occur from project-related emissions.

- D. Result in other emissions (such as those leading to odors) adversely affecting a substantial number of people?

FINDING: LESS THAN SIGNIFICANT IMPACT:

Odor impacts on residential areas and other sensitive receptors, such as hospitals, day-care centers, schools, etc. warrant the closest scrutiny. Potential for odor impact occurs when a new odor source is located near an existing sensitive receptor or when a new sensitive receptor locates near an existing source of odor.

Per the Air Quality Analysis, the project site is not located within San Joaquin Valley Air Pollution Control District identified screening distances (one to two miles) of any odor-generating facilities. The project involves no industrial, agricultural or other uses typically associated with objectionable odors. As such, the project would generate no objectionable odors to affect people in the area.

Construction activities may generate temporary airborne odors during the operation of diesel-powered construction vehicles and the application of architectural coatings. However, these odors are generally not considered offensive. Emissions would be temporary and confined to the immediate vicinity of the construction site with the application of emission reduction strategies that are specifically designed to reduce nuisance air quality and odor emissions. Any odor impacts would be less than significant.

#### IV. BIOLOGICAL RESOURCES

Would the project:

- A. Has a substantial adverse effect, either directly or through habitat modifications, on any species identified as a candidate, sensitive, or special-status species in local or regional plans, policies, or regulations, or by the California Department of Fish and Wildlife or U.S. Fish and Wildlife Service?

FINDING: LESS THAN SIGNIFICANT WITH MITIGATION INCORPORATED:

The project was routed to the California Department of Fish and Wildlife (CDFW) and the U.S. Fish and Wildlife Service (USFWS) for review and comments. According to CDFW, a review of aerial imagery and documented species occurrence records in the California Natural Diversity Database (CNDDDB) indicates that the project site has the potential to support a number of special-status species. This includes impact to the State fully-protected and State and federally endangered blunt-nosed leopard lizard and San Joaquin kit fox; the State threatened San Joaquin antelope squirrel and Swainson's hawk; the State and federally endangered giant kangaroo rat and State species of special concern short-nosed kangaroo rat; a number of special-status and rare plants, including the State and federally endangered California jewel flower and the federally endangered San Joaquin woolly threads; State species of special concern: burrowing owl, loggerhead shrike, LeConte's thrasher, American badger, San Joaquin coachwhip, western spadefoot, California legless lizard, California glossy snake, and coast horned lizard. In order to adequately assess any potential project-related impacts to biological resources, CDFW required that surveys shall be conducted by a qualified wildlife biologist/botanist during the appropriate survey period(s) and using the appropriate protocol survey methodology in order to determine whether any special-status species are present at or near the project area. The project will be subject to the following Mitigation Measures as recommended by the CDFW:

\* **Mitigation Measures**

1. *A qualified biologist shall conduct a habitat assessment in advance of project implementation to determine if the project area or its immediate vicinity contains suitable habitat for San Joaquin kit fox (SJKF), assess presence/absence of SJKF by conducting surveys following the USFWS "Standardized recommendations for protection of SJKF prior to or during ground disturbance" (2011), and upon SJKF detection, consult with CDFW to discuss how to avoid take, or if avoidance is not feasible, acquire an Incidental Take Permit (ITP) prior to the project activities, pursuant to Fish and Game Code Section 2081 (b).*
2. *A qualified biologist shall conduct a habitat assessment in advance of project implementation to determine if the Project area or its immediate vicinity contains suitable habitat for Blunt-nosed leopard lizard (BNLL). If suitable habitat is present, prior to initiating any project activities, conduct surveys in accordance with the "Approved Survey Methodology for the Blunt-nosed Leopard lizard" (CDFG 2004). Complete BNLL surveys no more than one year prior to initiation of ground disturbance. Protocol-level surveys must be conducted on multiple dates during late spring, summer, and fall, and that within these time periods there are specific protocol-level date, temperature, and time parameters which must be adhered to. If BNLL is detected during protocol level surveys, CDFW shall be consulted to discuss how to implement project activities and avoid take.*
3. *A qualified biologist shall conduct a habitat assessment in advance of project implementation to determine if the project area or its immediate vicinity contains suitable habitat for San Joaquin Antelope Squirrel (SJAS). In areas of suitable habitat, a qualified biologist shall conduct focused daytime visual surveys for SJAS using line transects with 10- to 30-meter spacing. These surveys shall be*

*conducted between April 1 and September 20 during daytime temperatures between 68-86° F (CDFG 1990). If suitable habitat is present and surveys or trapping are not feasible, a 50-foot-minimum no-disturbance buffer shall be maintained around all small mammal burrows of suitable size for SJAS. If SJAS is detected, CDFW shall be consulted to discuss how to avoid take, or if avoidance is not feasible, to acquire an Incidental Take Permit (ITP) prior to ground-disturbing activities, pursuant to Fish and Game Code Section 2081 (b).*

- 4. A qualified wildlife biologist shall conduct surveys for nesting raptors following the survey methodology developed by the Swainson hawk (SWHA) Technical Advisory Committee (SWHA TAC 2000) prior to project initiation and that these surveys extend to a one half-mile radius surrounding the project area. If project activities take place during the normal bird breeding season (February 1 through September 15), additional pre-construction surveys for active nests are to be conducted by a qualified biologist no more than 10 days prior to the start of construction. If an active SWHA nest is found, a minimum one half-mile no-disturbance buffer shall be provided until the breeding season has ended or until a qualified biologist has determined that the birds have fledged and are no longer reliant upon the nest or parental care for survival. If SWHA are detected and the one half-mile no-disturbance nest buffer is not feasible, the California Department of Fish and Wildlife shall be consulted to determine if the project can avoid take. If SWHA cannot be avoided, an ITP prior to vegetation or ground-disturbing activities is necessary to comply with the California Endangered Species Act.*
- 5. A qualified biologist shall conduct a habitat assessment in advance of Project implementation to determine if the project area or its immediate vicinity contains suitable habitat for Giant Kangaroo Rat (GKR) and Short-nosed Kangaroo Rat (SNKR). If suitable habitat is present, a trapping plan for determining presence of GKR and SNKR shall be submitted to and approved by CDFW prior to subsequent trapping efforts. These surveys shall be conducted by a qualified biologist who holds a Memorandum of Understanding with CDFW for GKR and SNKR, and be conducted between April 1 and October 31, when kangaroo rats are most active. If suitable habitat is present and trapping is not feasible, a 50-foot-minimum no-disturbance buffer shall be conducted around all small mammal burrows. If GKR or SNKR are found within the project area during preconstruction surveys or construction activities, CDFW shall be consulted to discuss how to implement the project and avoid take; or if avoidance is not feasible, to acquire an Incidental Take Permit for GKR prior to any ground-disturbing activities, pursuant Fish and Game Code Section 2081(b).*
- 6. The project site shall be surveyed for special-status plants by a qualified botanist following the "Protocols for Surveying and Evaluating Impacts to Special Status Native Plant Populations and Sensitive Natural Communities" (CDFW 2018). In the absence of protocol-level surveys being performed, additional surveys may be necessary. The special-status plant species shall be avoided whenever possible by delineation and observing a no-disturbance buffer of at least 50 feet from the outer edge of the plant population(s) or specific habitat type(s) required by special-status plant species. If buffers cannot be maintained,*

*then the California Department of Fish and Wildlife (CDFW) shall be consulted to determine appropriate minimization and Mitigation Measures for impacts to special-status plant species. If a California Endangered Species Act (CESA)-listed plant species is identified during botanical surveys, CDFW shall be consulted to determine if the project can avoid take. If take cannot be avoided, take authorization may be warranted. Take authorization would occur through issuance of an Incidental Take Permit by CDFW, pursuant to Fish and Game Code Section 2081(b).*

- 7. A qualified biologist shall conduct a habitat assessment in advance of project implementation to determine if the project area or its vicinity contains suitable habitat for Burrowing Owl (BUOW). If suitable habitat is present on or in the vicinity of the project area, a qualified biologist shall conduct surveys following the California Burrowing Owl Consortium's (CBOC) "Burrowing Owl Survey Protocol and Mitigation Guidelines" (CBOC 1993) and CDFW's "Staff Report on Burrowing Owl Mitigation" (CDFG 2012). Three or more surveillance surveys shall be conducted during daylight with each visit occurring at least three weeks apart during the peak breeding season (April 15 to July 15), when BUOW are most detectable. In addition, the surveys shall include a 500-foot buffer around the Project area. No-disturbance buffers, as outlined in the "Staff Report on Burrowing Owl Mitigation" (CDFG 2012) shall be implemented prior to and during any ground-disturbing activities. Specifically, any impacts to occupied burrows shall be avoided in accordance with the following table unless a qualified biologist approved by the California Department of Fish and Wildlife verifies through non-invasive methods that either: 1) the birds have not begun egg laying and incubation; or 2) that juveniles from the occupied burrows are foraging independently and are capable of independent survival.*
- 8. If Burrowing Owl (BUOW) are found within these recommended buffers and avoidance is not possible, burrow exclusion shall be conducted according to the Staff Report (CDFG 2012) by qualified biologists and only during the non-breeding season, before breeding behavior is exhibited and after the burrow is confirmed empty through non-invasive methods, such as surveillance. Also, occupied burrows shall be replaced with artificial burrows at a ratio of one burrow collapsed to one artificial burrow constructed (1:1) as mitigation for the potentially-significant impact of evicting BUOW.*
- 9. A qualified biologist shall conduct a habitat assessment in advance of project implementation to determine if the project area or its immediate vicinity contain suitable habitat for Loggerhead shrike, LeConte's thrasher, American badger, San Joaquin coachwhip, western spadefoot, California legless lizard, California glossy snake, coast horned lizard, and American badger. If suitable habitat is present, a qualified biologist shall conduct focused surveys for applicable species and their requisite habitat features to evaluate potential impacts resulting from ground and vegetation disturbance. Avoidance whenever possible is encouraged via delineation and observance a 50-foot no-disturbance buffer around dens of mammals like the American badger, as well as burrows which*

*can provide refuge for small mammals, reptiles, and amphibians, and 100 feet around nests of special-status bird species.*

*10. In addition to consultation with the California Department of Fish and Wildlife's (CDFW) Regional California Endangered Species Act staff, CDFW's Regional Ecological Reserve Management Unit staff shall also be consulted in advance of project initiation to demonstrate accurate delineation of property boundaries to prevent encroachment on CDFW-owned lands. Consultation is also recommended to discuss planned ingress and egress to the project area for the purposes of preventing encroachment on CDFW-owned lands. John Battistoni, Regional Ecological Reserve Management Unit Supervisor, shall be contacted via email at [John.Battistoni@wildlife.ca.gov](mailto:John.Battistoni@wildlife.ca.gov) or via telephone at 559-243-4014 extension 219.*

According to the U.S. Fish and Wildlife Service (USFWS), the proposed project is located within the range of the federally endangered San Joaquin kit fox and blunt-nosed leopard lizard. Both species have been documented in the California Natural Diversity Database within five miles of the proposed project site. In addition, the project is located within a kit fox recovery area, which has been identified as historically and/or currently occupied by the Pleasant Valley satellite kit fox population. Given that kit fox and lizard species are known to occur in the area, USFWS recommended that a habitat assessment of the proposed project site be conducted by a qualified biologist to determine whether the site contains suitable habitat for these or any other listed species.

A Biological Habitat Assessment (Report) prepared by Colibri Ecological Consulting, LLC, dated April 2019 was provided to the California Department of Fish and Wildlife (CDFW) and the U.S. Fish and Wildlife Service (USFWS) for review and comments. No comments on the Report were provided by CDFW. USFWS concurred with the Report's findings and Mitigation Measures and offered no further comments.

According to the Biological Habitat Assessment (Report), a field reconnaissance survey of the property was conducted on April 1, 2019. To evaluate and document the potential for the project site to support federally or state protected resources, the site was walked and thoroughly inspected, a surrounding 50-foot buffer was inspected with 10x42 binoculars, and a 0.5-mile buffer was evaluated for its potential to support nesting special-status raptors. All plants on the project site and all animals (vertebrate wildlife species) observed in the survey area were identified and documented. The project site and surrounding 50-foot buffer were evaluated for the presence of regulated habitats, including lakes, streams, and other waters using methods described in the *Wetlands Delineation Manual* and regional supplement (USACE 1987, 2008) and as defined by CDFW.

The survey revealed that the project site consists of dense, nonnative annual grassland dominated by red brome, gravel roads, and disturbed areas remnant of past oil and gas mining activities. Three abandoned oil pipes could serve as potential dens for San Joaquin kit fox, and a kit fox was observed immediately west of the site on the Pleasant Valley Ecological Reserve. Although most of the site aside from gravel roads and

disturbed areas was covered in dense grass, the site included several small patches of bare ground. These patches supported kangaroo rat burrows. Although kangaroo rat burrows were especially evident in bare patches, burrows were distributed at a moderate density across the entire project site. An unnamed ephemeral blue-line drainage is at the far northwest corner of the site.

Per the Biological Habitat Assessment (Report), USFWS provided a list of nine endangered or candidate species under the Federal Endangered Species Act (FESA) to consider in the project analysis, namely: endangered San Joaquin woollythreads, the threatened vernal pool fairy shrimp, the threatened Delta smelt, the threatened California red-legged frog, the threatened California tiger salamander, the endangered blunt-nosed leopard lizard, the threatened giant garter snake, the endangered giant kangaroo rat, and the endangered San Joaquin kit fox. The Report notes that searching the California Natural Diversity Database (CNDDDB) for records of special-status species, 15 species were found to exist within five miles of the project site, and likewise, searching the California Native Plant Society (CNPS) inventory of rare and endangered plants produced records of 30 species, 15 of which are rare, threatened, or endangered in California.

Per the Biological Resource Evaluation (Report), the project will result in permanent and temporary impacts to saltbush scrub and nonnative annual grassland habitats causing loss of natural land as a habitat for San Joaquin kit fox, San Joaquin antelope squirrel, short-nosed kangaroo rat, and other special-status species, and requires that the project shall adhere to the following Mitigation Measures in order to reduce impact to special-status species to less than significant levels.

\* **Mitigation Measures**

*To mitigate impact to natural lands, the project proponent shall do the following*

- 1. To mitigate for permanent impacts to natural lands by permanently conserving similar vegetation communities (grassland, saltbush scrub) that provide habitat for San Joaquin kit fox, San Joaquin antelope squirrel, and short-nosed kangaroo rat, provide one-acre of mitigation land for each acre of development authorized.*
- 2. Permanently protect mitigation land through a conservation easement deeded to a nonprofit conservation organization or public agency with a conservation mission.*
- 3. Develop and implement a mitigation land management plan to address long-term ecological sustainability and maintenance of the site.*
- 4. Fund the maintenance and management of mitigation land by establishing a long-term funding mechanism such as an endowment.*
- 5. Mitigation lands shall be on, adjacent to, or near the Project site where possible.*
- 6. Where there is insufficient habitat on, adjacent to, or near Project site, acquire*

*mitigation lands with habitat for San Joaquin kit fox, San Joaquin antelope squirrel and short-nosed kangaroo rat away from the Project site.*

- 7. Alternatively, if the project site is within the service area of a California Department of Fish and Wildlife-approved conservation bank, purchase available conservation bank credits from that bank.*

Per the Biological Habitat Assessment (Report), construction activities such as excavating, trenching, grading, or other ground-disturbing activities that could disturb or harm a special-status species or substantially modify its habitat could constitute a significant impact and requires that the project shall adhere to the following Mitigation Measures in order to reduce impact to special-status species to less than significant levels.

\* **Mitigation Measures**

- 1. To protect brittlescale, crownscale, San Joaquin woollythreads, and recurved larkspur, a qualified biologist shall survey the project site during the flowering period (February - May for San Joaquin woollythreads and recurved larkspur; June - October for brittlescale; March - October for crownscale) for these species following the Protocols for Surveying and Evaluating Impacts to Special Status Plant Populations and Sensitive Natural Communities [California Department of Fish and Wildlife (CDFW) 2018b]. If any of these species is present, the qualified biologist shall stake and flag no-disturbance exclusion zones of 100 feet around these plants prior to construction activities. These exclusion zones shall remain in place throughout construction activities. If these exclusion zones cannot be maintained, the project proponent shall consult with CDFW to determine appropriate measures to implement to minimize or mitigate impacts to special-status plants.*
- 2. To protect San Joaquin coachwhip and California glossy snake, a qualified biologist shall conduct pre-construction surveys where suitable habitat is identified within proposed work areas immediately prior to ground-disturbing activities. If either species is found, work shall not begin until the animal has moved out of the work area on its own. During construction, a qualified biologist shall inspect open trenches, pits, and construction equipment and materials left on site for snakes each morning prior to the start of work and at the end of each workday.*
- 3. To protect blunt-nosed leopard lizard, a qualified biologist shall establish no-disturbance exclusion zones of 50 feet around all occupied or potentially-occupied burrows. A qualified biologist shall inspect open trenches for blunt-nosed leopard lizards each day prior to the start of work and at the end of each workday. If a blunt-nosed leopard lizard is found, all construction activities shall halt until it has moved out of the work area on its own. If ground-disturbing activities cannot avoid burrows, surveys following the methods described in Approved Survey Methodology for the Blunt-nosed Leopard Lizard (CDFG 2004) shall be conducted within one year of ground-disturbing activities*

*to determine whether the species is present or absent. The results of these surveys shall be submitted to the California Department of Fish and Wildlife (CDFW). If a blunt-nosed leopard lizard is found at any time in the Project area, the project proponent shall consult with CDFW to discuss how to implement the Project to avoid take.*

- 4. To protect Loggerhead shrike, construction shall be scheduled to avoid the nesting season, which extends from February through August. If it is not possible to schedule construction between September and January, preconstruction surveys for nesting birds shall be conducted by a qualified biologist to ensure that no active nests will be disturbed during Project implementation. A pre-construction survey shall be conducted no more than 14 days prior to the initiation of construction activities. During this survey, the qualified biologist shall inspect all potential nest substrates in and immediately adjacent to the impact areas for nests. If an active nest is found close enough to the construction area to be disturbed by these activities, the qualified biologist shall determine the extent of a construction-free buffer to be established around the nest. If work cannot proceed without disturbing the nesting birds, work may need to be halted or redirected to other areas until nesting and fledging are completed, or the nest has otherwise failed for non-construction-related reasons.*
- 5. To protect San Joaquin antelope squirrel, a qualified biologist shall conduct pre-construction surveys for the species (Harris and Stearns 1991). If the species is detected near active work areas, the qualified biologist shall establish an exclusion zone of 50 feet around occupied or potentially-occupied burrows. If work must take place in the exclusion zone, the project proponent must consult with the California Department of Fish and Wildlife to determine if take can be avoided. If take cannot be avoided, an Incidental Take Permit pursuant to California Fish and Game Code Section 2081 must be obtained to comply with the California Endangered Species Act.*
- 6. To protect short-nosed kangaroo rat, a qualified biologist shall flag occupied or potentially-occupied burrows and establish 50-foot exclusion zones for avoidance. If these exclusion zones cannot be maintained, the project proponent shall consult with the California Department of Fish and Wildlife (CDFW) to determine appropriate measures to implement to minimize or mitigate impacts to short-nosed kangaroo rat.*
- 7. To protect American badger, a qualified biologist shall conduct a preconstruction survey for the species. If American badger or American badger activity (e.g., dens, diggings) are detected, the qualified biologist shall establish no-disturbance exclusion zones of 50 feet between active dens and the work area. If these exclusion zones cannot be maintained, the project proponent shall consult with the California Department of Fish and Wildlife to determine appropriate measures to implement to minimize or mitigate impacts to American badger.*



8. *To protect San Joaquin kit fox, a qualified biologist shall conduct a preconstruction survey to identify potential dens, including potential atypical dens (i.e., manmade structures), in the Project area. If potential San Joaquin kit fox dens are present, their disturbance and destruction shall be avoided. If potential dens are located within the proposed work area and cannot be avoided during construction, a qualified biologist shall determine if the dens are occupied following the U.S. Fish and Wildlife Service Standardized Recommendations for Protection of the Endangered San Joaquin Kit Fox Prior or During Ground Disturbance (USFWS 2011). If unoccupied, the qualified biologist will remove these dens by hand, excavating them in accordance with USFWS procedures (USFWS 2011). When occupied or potentially-occupied San Joaquin kit fox dens are adjacent to the work area, exclusion zones shall be implemented following USFWS procedures. Exclusion zones shall be determined based on the type of den and current use: Potential Den: 50 feet; Known Den: 100 feet; Natal or Pupping Den: to be determined on a case-by case basis in coordination with USFWS and CDFW. All pipes greater than 4 inches in diameter stored on the construction site shall be capped, and exit ramps shall be installed in trenches and other excavations to avoid direct mortality. When possible, construction shall be conducted from October 1 to November 30, outside of the breeding season. If occupied dens cannot be avoided, the project proponent shall consult with the U.S. Fish and Wildlife Service and California Department of Fish and Wildlife to determine whether Incidental Take Permits may be needed to comply with the Federal Endangered Species Act and California Endangered Species Act.*

B. Have a substantial adverse effect on any riparian habitat or other sensitive natural community identified in local or regional plans, policies, regulations, or by the California Department of Fish and Wildlife or U.S. Fish and Wildlife Service?

FINDING: NO IMPACT:

Per the Biological Resource Evaluation, no riparian habitat or other sensitive natural community is present in the project site. No impact would occur.

C. Have a substantial adverse effect on state or federally-protected wetlands (including, but not limited to, marsh, vernal pool, coastal, etc.) through direct removal, filling, hydrological interruption, or other means?

FINDING: LESS THAN SIGNIFICANT IMPACT WITH MITIGATION  
INCORPORATED:

An Aquatic Resource Delineation Report (Report) prepared for the project by Argonaut Ecological Consulting, Inc., dated December 3, 2019 was provided to the Army Corps of Engineers and California Department of Fish and Wildlife for review and comments. No comments on the Report were provided by either agency.

According to the Report, there is a total of 0.99 acre of potential waters/wetlands (ephemeral stream) within the outermost northwesterly corner of the subject 78.18-acre

project site. An approximately six-acre portion of the project site to be occupied by the proposed flea market is located 4,770 feet (0.9 mile) southeast of the 0.99 acre of potential waters/wetlands. Given the distance, the project is not expected to any have adverse effect on federally-protected wetlands as defined by Section 404 of the Clean Water Act. To further ensure that the wetland area is protected from the project-related activities, the project will adhere to the following Mitigation Measure:

\* **Mitigation Measure**

1. *The project proponent shall ensure that all activities related to the flea market operation remain within the limits of the project boundaries as shown on the approved Site Plan, and must not encroach upon the 0.99 acre of potential waters/wetlands located within the outermost northwesterly corner of the project site as identified by Aquatic Resource Delineation Report prepared by Argonaut Ecological Consulting, Inc., and dated December 3, 2019.*

- D. Interfere substantially with the movement of any native resident or migratory fish or wildlife species or with established native resident or migratory wildlife corridors, or impede the use of native wildlife nursery sites?

FINDING: LESS THAN SIGNIFICANT IMPACT WITH MITIGATION  
INCORPORATED:

Per the Biological Resource Evaluation (Report), the project could impede the use of nursery sites for native birds protected under the Migratory Bird Treaty Act and California Fish and Game Code. Construction activities such as excavating, trenching, and grading that disturb a nesting bird on the site or immediately adjacent to the construction zone could constitute a significant impact. Therefore, the project shall adhere to the following Mitigation Measures in order to reduce impact to nesting birds to less than significant levels.

\* **Mitigation Measures**

1. *To the extent practicable, construction shall be scheduled to avoid the nesting season, which extends from February through August.*
2. *If it is not possible to schedule construction between September and January, pre-construction surveys for nesting birds shall be conducted by a qualified biologist to ensure that no active nests will be disturbed during project implementation. A pre-construction survey shall be conducted no more than 14 days prior to the initiation of construction activities. During this survey, the qualified biologist shall inspect all potential nest substrates in and immediately adjacent to the impact areas for nests. If an active nest is found close enough to the construction area to be disturbed by these activities, the qualified biologist shall determine the extent of a construction-free buffer to be established around the nest. If work cannot proceed without disturbing the nesting birds, work may need to be halted or redirected to other*

*areas until nesting and fledging are completed or the nest has otherwise failed for non-construction-related reasons.*

- E. Conflict with any local policies or ordinances protecting biological resources, such as a tree preservation policy or ordinance?

FINDING: NO IMPACT:

The project site is a grazing land and contains no trees that may require removal due to the project development. The project is not in conflict with the County's tree preservation policies for oak trees.

- F. Conflict with the provisions of an adopted Habitat Conservation Plan, Natural Community Conservation Plan, or other approved local, regional, or state Habitat Conservation Plan?

FINDING: NO IMPACT:

The project site is within PG&E's San Joaquin Valley Operations and Maintenance (O&M) Habitat Conservation Plans (HCP). The proposed development will not be against HCP which is applicable to PG&E projects only.

## V. CULTURAL RESOURCES

Would the project:

- A. Cause a substantial adverse change in the significance of a historical resource pursuant to Section 15064.5; or
- B. Cause a substantial adverse change in the significance of an archaeological resource pursuant to Section 15064.5; or
- C. Disturb any human remains, including those interred outside of formal cemeteries?

FINDING: LESS THAN SIGNIFICANT IMPACT WITH MITIGATION  
INCORPORATED:

The project site is in an area moderately sensitive to archeological resources. The Southern San Joaquin Valley Information (SSJVIC) of the California Historical Resources Information Center (CHRIS) stated that the project area has not been surveyed, and due to its archeological sensitivity, prehistoric or historical cultural resources may be present on the project site. As such, an archaeological survey should be conducted by a professional archaeologist. Per this recommendation, a Cultural Resource Assessment (Study) was prepared for the project by Peak & Associates, Inc., dated November 5, 2019, and a copy was provided to SSJVIC.

According to the Cultural Resources Assessment (Study) prepared by Vang Inc. Consulting Engineers, a field survey of the project site conducted by an archeologist on

October 14 and 15, 2019 found no prehistoric sites. However, given the area is archeologically sensitive, and that there is a slight possibility that a site may exist and be totally obscured by vegetation, fill, or other historic activities, leaving no surface evidence, the Study recommended that should artifacts or unusual amounts of stone, bone, or shell be uncovered during construction activities, an archeologist should be consulted for on-the-spot evaluation of the finding. If the Sheriff-Coroner determines that the bone is human and is most likely Native American in origin, the Native American Heritage Commission must be contacted. Implementation of the following Mitigation Measure would reduce the potential impacts on cultural resources to less than significant levels.

\* **Mitigation Measure**

1. *In the event that cultural resources are unearthed during ground-disturbing activities, all work shall be halted in the area of the find. An Archeologist shall be called to evaluate the findings and make any necessary mitigation recommendations. If human remains are unearthed during ground-disturbing activities, no further disturbance is to occur until the Fresno County Sheriff-Coroner has made the necessary findings as to origin and disposition. All normal evidence procedures should be followed by photos, reports, video, etc. If such remains are determined to be Native American, the Sheriff-Coroner must notify the Native American Commission within 24 hours.*

A cultural resources records search conducted at Native American Heritage Commission turned out to be negative.

## VI. ENERGY

Would the project:

- A. Result in potentially significant environmental impact due to wasteful, inefficient, or unnecessary consumption of energy resources during project construction or operation?

FINDING: LESS THAN SIGNIFICANT IMPACT:

The project would result in less than significant consumption of energy (gas, electricity, gasoline, and diesel) during its construction. Limited construction activities involving a new restroom facility and canopies and corresponding fuel energy consumption would be temporary and localized. There are no unusual project characteristics that would cause the use of construction equipment to be less energy efficient compared with other similar construction sites in other parts of the State. Therefore, construction-related fuel consumption by the Project would not result in inefficient, wasteful, or unnecessary energy use compared with other construction sites in the area.

The project will be subject to meeting California Green Building Standards Code (CCR, Title 24, Part 11-CALGreen) to achieve the goals of Assembly Bill (AB) 32, which has established a comprehensive program of cost-effective reductions of greenhouse gases (GHG) to 1990 levels by 2020.

- B. Conflict with or obstruct a state or local plan for renewable energy or energy efficiency?

FINDING: NO IMPACT:

The project development would not conflict with or obstruct a state or local plan for renewable energy or energy efficiency.

The project involves limited construction activities relating to a new restroom facility, canopies, vendors' areas, and onsite parking. Where applicable, all construction activities would comply with the 2019 Building Energy Efficiency Standards effective January 1, 2020. Pursuant to the California Building Standards Code and the Energy Efficiency Standards, the County would review the design components of the project's energy conservation measures when the project's building plans are submitted.

## VII. GEOLOGY AND SOILS

Would the project:

- A. Directly or indirectly cause potential substantial adverse effects, including the risk of loss, injury, or death involving:
  - 1. Rupture of a known earthquake fault, as delineated on the most recent Alquist-Priolo Earthquake Fault Zoning Map issued by the State Geologist for the area or based on other substantial evidence of a known fault?
  - 2. Strong seismic ground shaking?
  - 3. Seismic-related ground failure, including liquefaction?

FINDING: LESS THAN SIGNIFICANT IMPACT:

Per Figure 9-5 of the Fresno County General Plan Background Report, the project site is in an area which has 10 percent probability of seismic hazard in 50 years with peak horizontal ground acceleration of 40 to 60 percent. The project development would be subject to building standards, which include specific regulations to protect improvements against damage caused by earthquake and/or ground acceleration.

- 4. Landslides?

FINDING: NO IMPACT:

Per Figure 9-6 of the Fresno County General Plan Background Report, the project site is not located in an area of landslide hazards. The project site is flat with no topographical variations, which precludes the possibility of landslides.

- B. Result in substantial soil erosion or loss of topsoil?

FINDING: LESS THAN SIGNIFICANT IMPACT:

Per Figure 7-3 of the Fresno County General Plan Background Report, the project site is not in an area of erosion hazards. Grading activities resulting from this proposal may result in loss of some topsoil due to compaction and overcovering of soil for construction of building/structure for the project. However, the impact would be less than significant with a Project Note requiring that Engineered Grading Plans shall be approved, and a Grading Permit shall be obtained from the Development Engineering Section of the Development Services and Capital Projects Division prior to onsite grading activities.

- C. Be located on a geologic unit or soil that is unstable, or that would become unstable as a result of the project, and potentially result in on- or off-site landslide, lateral spreading, subsidence, liquefaction, or collapse?

FINDING: NO IMPACT:

As noted above, the project site is flat with no topographical variations. The site bears no potential for on or offsite landslide, lateral spreading, subsidence, liquefaction, or collapse due to the project-related improvements. As a standard requirement, a soil compaction report may be required to ensure the weight-bearing capacity of the soils for a building prior to construction permits being issued.

- D. Be located on expansive soil as defined in Table 18-1-B of the Uniform Building Code (1994), creating substantial direct or indirect risks to life or property?

FINDING: LESS THAN SIGNIFICANT IMPACT:

Per Figure 7-1 of the 2000 Fresno County General Plan Background Report, the project site is not in an area of expansive soils. However, the project construction will implement all applicable requirements of the most recent California Building Standards Code and will consider hazards associated with shrinking and swelling of expansive soils.

- E. Have soils incapable of adequately supporting the use of septic tanks or alternative wastewater disposal systems where sewers are not available for the disposal of wastewater?

FINDING: LESS THAN SIGNIFICANT IMPACT:

No community sanitary sewer is currently available to the project site. An individual sewage disposal system will be installed for the proposed restroom facility on the property.

According to the Fresno County Department of Public Health, Environmental Health Division (Health Department) review of the proposal, the project site is adequate in size to accommodate the sewage disposal system and expansion area, meeting the mandatory setbacks and policy requirements as established with the implementation of the Fresno County Tier 2 Local Area Management Plan (LAMP), onsite wastewater treatment system (OWTS) policy and California Plumbing Code. A Project Note would

require that the onsite sewage disposal system shall be installed under permit and inspection by the Department of Public Works and Planning, Building and Safety Section.

- F. Directly or indirectly destroy a unique paleontological resource or site or unique geologic feature?

FINDING: LESS THAN SIGNIFICANT IMPACT:

See discussion above in Section V. CULTURAL RESOURCES.

## VIII. GREENHOUSE GAS EMISSIONS

Would the project:

- A. Generate greenhouse gas emissions, either directly or indirectly, that may have a significant impact on the environment?

FINDING: LESS THAN SIGNIFICANT IMPACT:

Human activities, including fossil fuel combustion and land-use changes, release carbon dioxide (CO<sub>2</sub>) and other compounds cumulatively termed greenhouse gases (GHGs). GHGs are effective at trapping radiation that would otherwise escape the atmosphere. The San Joaquin Valley Air Pollution Control District (SJVAPCD), a California Environmental Quality Act (CEQA) Trustee Agency for this project, has developed thresholds to determine significance of a proposed project – either implement Best Performance Standards or achieve a 29 percent reduction from Business as Usual (BAU) (a specific numerical threshold). On December 17, 2009, SJVAPCD adopted *Guidance for Valley Land-Use Agencies in Addressing GHG Emission Impacts for New Projects under CEQA* (SJVAPCD 2009), which outlined SJVAPCD’s methodology for assessing a project’s significance for GHGs under CEQA.

Construction and operational activities associated with the proposed project would generate greenhouse gas (GHG) emissions. In the Greenhouse Gas Analysis Report, completed by Mitchell Air Quality Consulting and dated May 5, 2019, GHG emissions were estimated using the California Emissions Estimator Model (CalEEMod) version 2016.3.2 [California Air Pollution Control Officers Association (CAPCOA) 2017], which is the most current version of the model approved for use by SJVAPCD.

Per the Greenhouse Gas Analysis Report, the San Joaquin Valley Air Pollution Control District does not have an adopted threshold of significance for construction-related GHG emissions. Construction of the proposed project would generate approximately 74.57 metric tons of CO<sub>2</sub>e per year. Because construction emissions may remain in the atmosphere for years after construction is complete, construction emission when amortized for the project over 30 years would be 2.48 metric tons CO<sub>2</sub>e per year.

Regarding operation-related GHG Emissions, long-term GHG emissions occur over the life of the project and are typically generated from motor vehicles and trucks, energy

usage, waste generation, and area sources, such as consumer products and landscaping activities. The Greenhouse Gas Analysis Report indicates that the project would achieve a reduction of 21.7 percent from Business-As-Usual (BAU) by the year 2020 with regulations and design features incorporated. The project has no structures subject to energy efficiency regulations, operates only three days per week and produces relatively small amounts of GHG emissions compared to typical retail projects. Therefore, the project's operational emissions would be less than significant.

The 2017 Scoping Plan provides the State's strategy to achieve the SB 32 2030 target of a 40-percent reduction in emissions compared to 1990 levels. The Plan includes the existing and new measures that when implemented are expected to achieve the SB32 2030 target. Since the project would continue operations after 2020, the Greenhouse Gas Analysis Report estimates that the project would reduce emissions by 45.3 percent below BAU by 2030. Based on this result and the strong likelihood that the measures included in the 2017 Scoping Plan Update will be implemented, it is reasonable to conclude that the project is consistent with the 2017 Scoping Plan and will contribute a reasonable fair-share contribution (includes: Title 24 and CALGreen, regulations on energy production, fuels, and motor vehicles; voluntary actions to improve energy efficiency in existing development, and compliance with the vehicle miles traveled) to achieving the 2030 target.

- B. Conflict with an applicable plan, policy or regulation adopted for the purpose of reducing the emissions of greenhouse gases?

FINDING: LESS THAN SIGNIFICANT IMPACT:

The project will be subject to regulations developed under the 2008 Air Resources Board- adopted AB (Assembly Bill) 32 Scoping Plan, which focuses on reducing GHGs (CO<sub>2</sub>, methane, nitrous oxide, hydrofluorocarbons, perfluorocarbons, and sulfur hexafluoride) to 1990 levels by the year 2030. The Scoping Plan calls for reduction in California's GHG emissions, cutting approximately 30 percent (currently 21.7 percent) from BAU emission levels projected for 2020, or about 10 percent from 2008 levels. The Scoping Plan contains a variety of strategies to reduce the State's emissions. The project is consistent with most of the strategies while others are not applicable to the project.

## IX. HAZARDS AND HAZARDOUS MATERIALS

Would the project:

- A. Create a significant hazard to the public or the environment through the routine transport, use, or disposal of hazardous materials; or
- B. Create a significant hazard to the public or the environment through reasonably foreseeable upset and accident conditions involving the release of hazardous materials into the environment; or



- C. Emit hazardous emissions or handle hazardous or acutely hazardous materials, substances, or waste within one quarter-mile of an existing or proposed school?

FINDING: LESS THAN SIGNIFICANT IMPACT WITH MITIGATION  
INCORPORATED:

Upon reviewing the subject Initial Study No. 7568 during public review period, the California Department of Toxic Substances Control (CDTSC) indicated that the project site activities can potentially result in the release of hazardous wastes/substances and recommended that steps shall be taken to reduce the impact. As such, prior to the issuance of building permits, the project will be adhering to the following recommendation made by CDTSC and noted below as mitigation measures in bold/underline.

\* **Mitigation Measures**

1. **If buildings or other structures are to be demolished on any project sites included in the proposed project, prior to the issuance of building permits, surveys shall be conducted for the presence of lead-based paints or products, mercury, asbestos containing materials, and polychlorinated biphenyl caulk. Removal, demolition and disposal of any of the above-mentioned chemicals shall be conducted in compliance with California environmental regulations and policies. In addition, sampling near current and/or former buildings shall be conducted in accordance with DTSC's 2006 Interim Guidance Evaluation of School Sites with Potential Contamination from Lead Based Paint, Termiticides, and Electrical Transformers ([https://dtsc.ca.gov/wpcontent/uploads/sites/31/2018/09/Guidance\\_Lead\\_Contamination\\_050118.pdf](https://dtsc.ca.gov/wpcontent/uploads/sites/31/2018/09/Guidance_Lead_Contamination_050118.pdf)).**
2. **If any projects initiated as part of the proposed project require the importation of soil to backfill any excavated areas, prior to the issuance of building permits, proper sampling shall be conducted to ensure that the imported soil is free of contamination and the imported materials be characterized according to DTSC's 2001 Information Advisory Clean Imported Fill Material ([https://dtsc.ca.gov/wpcontent/uploads/sites/31/2018/09/SMP\\_FS\\_Cleanfill-Schools.pdf](https://dtsc.ca.gov/wpcontent/uploads/sites/31/2018/09/SMP_FS_Cleanfill-Schools.pdf)).**
3. **If any sites included as part of the proposed project have been used for agricultural, weed abatement or related activities, prior to issuance of building permits, the current and former agricultural lands shall be evaluated in accordance with DTSC's 2008 Interim Guidance for Sampling Agricultural Properties (Third Revision) (<https://dtsc.ca.gov/wpcontent/uploads/sites/31/2018/09/Ag-Guidance-Rev-3-August-7-2008-2.pdf>).**

The project does not involve transport, use, disposal, release, or handling of hazardous materials which may create hazard to the public or the environment. The nearest school, Sunset School in City of Coalinga, is approximately 7.5 miles west of the project site.

An environmental site check investigation was conducted by SIA Investigation, Inc on November 29, 2018 to document any sign of oil contaminates emanating from the ground throughout the 78.18-acre project site. The investigator conducted a grid search of the property, documenting the property ground with still photographs and video footage. No evidence could be found such as abnormal disturbances or odors from the soil to suggest there was any type of hazardous oil contaminate leakage emanating from the ground on the property.

The Fresno County Department of Public Health, Environmental Health Division reviewed the project and required that the following shall be included as a Project Note: If any underground storage tank(s) are found during construction, the applicant shall apply for and secure an Underground Storage Tank Removal Permit from the Fresno County Department of Public Health, Environmental Health Division.

- D. Be located on a site which is included on a list of hazardous materials sites compiled pursuant to Government Code Section 65962.5 and, as a result, would it create a significant hazard to the public or the environment?

FINDING: NO IMPACT:

Per the U.S. EPA's NEPAassist, the project site is not listed as a hazardous materials site. The project will not create hazards to the public or the environment.

- E. For a project located within an airport land use plan or, where such a plan has not been adopted, within two miles of a public airport or public use airport, result in a safety hazard or excessive noise for people residing or working in the project area?

FINDING: NO IMPACT:

Per the Fresno County *Airport Land Use Compatibility* Plan Update adopted by the Airport Land Use Commission (ALUC) on December 3, 2018, the nearest public airport, New Coalinga Municipal Airport, is approximately 3.2 miles west of the project site. Given the distance, the airport will not result in a safety hazard or excessive noise for people visiting the project site.

- F. Impair implementation of or physically interfere with an adopted emergency response plan or emergency evacuation plan?

FINDING: NO IMPACT:

The project site is in an area where existing emergency response times for fire protection, emergency medical services, and sheriff protection meet adopted standards. The project does not include any characteristics (e.g., permanent road closures) that would physically impair or otherwise interfere with emergency response or evacuation in the project vicinity. These conditions preclude the possibility of the proposed project conflicting with an emergency response or evacuation plan. No impacts would occur.

- G. Expose people or structures, either directly or indirectly, to a significant risk of loss, injury or death involving wildland fires?

FINDING: NO IMPACT:

Per Figure 9-9 of the Fresno County General Plan Background Report, the project site is outside of the State Responsibility area for wildland fire protection. The project will not expose persons or structures to wildland fire hazards.

- X. HYDROLOGY AND WATER QUALITY

Would the project:

- A. Violate any water quality standards or waste discharge requirements or otherwise substantially degrade surface or groundwater quality?

FINDING: LESS THAN SIGNIFICANT IMPACT WITH MITIGATION  
INCORPORATED:

See discussion in Section VII. E. GEOLOGY AND SOILS regarding wastewater discharge.

The project proponent intends to use an existing onsite well to provide potable water to the project.

The project review by the State Water Resources Control Board (SWRCB), Division of Drinking Water (DDW) indicates that the proposed facility shall be permitted by that agency as a public water system classified as a transient non-community water system and be in compliance with Senate Bill 1263 (SB 1263). The Bill requires that prior to applying for a permit for a proposed new public water system, the applicant first submit a preliminary technical report before initiating construction of any water-related improvement which will analyze the feasibility of connecting to an existing community water system for water service. SWRCB-DDW also requires that the applicant shall conduct water quality testing of the existing well in accordance with the requirements for a community water system, as the wells proposed to provide drinking water must be demonstrated to meet Title 22 drinking water standards. Furthermore, the applicant shall obtain a permit to operate the public water system from SWRCB-DDW.

The applicant is in the process of complying with the SWRCB-DDW requirements related to the provision of a public water system. The project will not violate any water quality standards with the adherence to the following Mitigation Measure:

\* **Mitigation Measure**

1. *Prior to the issuance of building permits and at the time of Site Plan Review for the proposed facility, the project proponent shall complete all water-related requirements for the project as required by and to the satisfaction of the State Water Resources Control Board (SWRCB), Division of Drinking Water (DDW).*

*The project proponent shall also obtain permits from SWRCB-DDW prior to operating a public water system.*

The project review by the Fresno County Department of Public Health, Environmental Health Division requires the following to be included as Project Notes: 1) in an effort to protect groundwater, all abandoned water wells on the parcel shall be properly destroyed by an appropriately-licensed contractor; 2) prior to destruction of agricultural wells, a sample of the uppermost fluid in the well column shall be checked for lubricating oil; 3) should lubricating oil be found in the well, the oil shall be removed from the well prior to placement of fill material for destruction; and 4) the "oily water" removed from the well must be handled in accordance with federal, state and local government requirements.

The Regional Water Quality Control Board, Central Valley Region expressed no concerns related to the project impact on groundwater quality.

- B. Substantially decrease groundwater supplies or interfere substantially with groundwater recharge such that the project may impede sustainable groundwater management of the basin?

FINDING: LESS THAN SIGNIFICANT IMPACT:

According to the applicant, an estimated 300 gallons of water will be used during each Friday, Saturday and Sunday the flea market will operate. The water supply will come from an existing onsite well subject to meeting the State Water Resources Control Board, Division of Drinking Water's requirements for a public water system as noted above.

The project site is in a water-short area of Fresno County. The Water and Natural Resources Division of the Fresno County Department of Public Works and Planning reviewed the subject proposal and expressed no concerns related to water supply to the project. The project would not deplete groundwater resources. The impacts would be less than significant.

- C. Substantially alter the existing drainage pattern of the site or area, including through the alteration of the course of a stream or river or through the addition of impervious surfaces, in a manner which would:
1. Result in substantial erosion or siltation on or off site; or
  2. Substantially increase the rate or amount of surface runoff in a manner which would result in flooding on or off site; or
  3. Create or contribute runoff water which would exceed the capacity of existing or planned storm water drainage systems or provide substantial additional sources of polluted runoff; or
  4. Impede or redirect flood flows?

FINDING: LESS THAN SIGNIFICANT IMPACT:

According to the United States Geological Survey Quad Maps, no natural drainage channels run through the subject property. A seasonal stream/water channel runs approximately 0.7 mile to the north of the northern boundary of the project site.

Development of the subject proposal will not cause significant changes in the absorption rates, drainage patterns, or the rate and amount of surface run-off with adherence to the mandatory construction practices contained in the Grading and Drainage Sections of the County Ordinance Code. Per the comments provided by the Development Engineering Section of the Fresno County Department of Public Works and Planning, Project Notes would require that an Engineered Grading Plan shall be submitted, reviewed and approved and a grading permit shall be obtained prior to any onsite grading work.

- D. In flood hazard, tsunami, or seiche zones, risk release of pollutants due to project inundation?

FINDING: NO IMPACT:

Per Figure 9-7 of the Fresno County General Plan Background Report, the project site is not located in a 100-Year-Flood Inundation Area and is not subject to flooding from the 100-year storm per the Federal Emergency Management Agency FIRM Panel 3250H.

- E. Conflict with or obstruct implementation of a water quality control plan or sustainable groundwater management plan?

FINDING: NO IMPACT:

The project is not in conflict with any water quality control plan or sustainable groundwater management plan. Per the State Water Resources Control Board, Division of Drinking Water, there is no Water Quality Control Plan for Fresno County. The project is located within Westside GSA, also known as Westlands Water District (WWD) and was routed to WWD in care of Westside Groundwater Sustainability Agency for review and comments. No concerns were expressed by that agency.

XI. LAND USE AND PLANNING

Would the project:

- A. Physically divide an established community?

FINDING: NO IMPACT:

The project site is approximately 6.4 miles east of the City of Coalinga. The project will not divide an established community.

- B. Cause a significant environmental impact due to a conflict with any land use plan, policy, or regulation adopted for the purpose of avoiding or mitigating an environmental effect?

FINDING: LESS THAN SIGNIFICANT IMPACT:

The subject property is designated as Westside Rangeland in the Coalinga Regional Plan and is not located within the Sphere of Influence (SOI) of a city. As such, the subject proposal will not conflict with any land use plan, policy, or regulation of an agency with jurisdiction (other than County) over the project.

The County General Plan allows an agricultural commercial center consisting of a flea market in an agriculturally-zoned parcel by discretionary land use approval, provided the use meets applicable General Plan policies. The proposed project (flea market) meets Policy LU-A.3, criteria a - d in that there is no such facility which requires a large piece of land preferably away from urban development, and which is currently serving the project area; the project site is a grazing land and not a prime farmland; the limited water used by the project will not impact groundwater resources, or alternatively the project will be connected to a community water system; and the project can be served by adequate workforce from the nearby communities of Coalinga, Huron and others. The project also meets the Policy LU-A.3, criteria e. relating to the establishment of the an agricultural commercial center.

The project meets Policy LU-A.13 and Policy LU-A.14 in that the project site is a grazing land; does not abut productive farmland; and will be fenced off to be isolated from abutting parcels. The project meets Policy PF-C.17 in that due to limited water usage, it will have no significant impact on groundwater resources. The project meets Policy PF-D.6 in that it will utilize an individual sewage disposal system, as no community sanitary system is currently available in the area.

## XII. MINERAL RESOURCES

Would the project:

- A. Result in the loss of availability of a known mineral resource that would be of value to the region and the residents of the state; or
- B. Result in the loss of availability of a locally-important mineral resource recovery site delineated on a local General Plan, Specific Plan or other land use plan?

FINDING: NO IMPACT:

Per Figure 7-8 of the Fresno County General Plan Background Report, the project site is outside of a mineral-producing area of the County.

## XIII. NOISE

Would the project result in:

- A. Generation of a substantial temporary or permanent increase in ambient noise levels in the vicinity of the project in excess of standards established in the local general plan or noise ordinance, or applicable standards of other agencies; or
- B. Generation of excessive ground-borne vibration or ground-borne noise levels?

FINDING: LESS THAN SIGNIFICANT IMPACT:

The project will operate on Friday, Saturday and Sunday from 5 a.m. to 10 p.m., generating an estimated 500 customers, patrons and members. Outside vendors will use music entertainment during the daylight hours and may also use sound amplifications. All these activities will potentially generate additional noise impacting surrounding properties.

An Acoustical Analysis (Report) was prepared for the project by WJV Acoustics, Inc, dated March 25, 2019. Based on the project site plan, proposed activities and the noise levels that could be produced by amplified sound systems at the project site, the Report concludes that the project-related noise levels are not expected to exceed the applicable County of Fresno daytime (7:00 a.m. to 10:00 p.m.) or nighttime (10:00 p.m. to 7:00 a.m.) noise level standards at any offsite noise-sensitive land uses. The Report recommended no Mitigation Measures.

The Fresno County Department of Public Health, Environmental Health Division concurred with the findings of the Acoustical Analysis, and expressed no concerns related to noise.

- C. For a project located within the vicinity of a private airstrip or an airport land use plan or, where such a plan has not been adopted, within two miles of a public airport or public use airport, would the project expose people residing or working in the project area to excessive noise levels?

FINDING: NO IMPACT:

See discussion above in Section IX. E.

#### XIV. POPULATION AND HOUSING

Would the project:

- A. Induce substantial unplanned population growth in an area, either directly (for example, by proposing new homes and businesses) or indirectly (for example, through extension of roads or other infrastructure); or
- B. Displace substantial numbers of existing people or housing, necessitating the construction of replacement housing elsewhere?

FINDING: NO IMPACT:

The project will not result in an increase of housing, nor will it otherwise induce population growth.

## XV. PUBLIC SERVICES

Would the project:

- A. Result in substantial adverse physical impacts associated with the provision of new or physically-altered governmental facilities, or the need for new or physically-altered governmental facilities, the construction of which could cause significant environmental impacts, in order to maintain acceptable service ratios, response times or other performance objectives for any of the following public services:

1. Fire protection?

FINDING: LESS THAN SIGNIFICANT IMPACT:

Per the initial review of the project by the Fresno County Fire Protection District (CalFire), the project shall comply with the California Code of Regulations Title 24 – Fire Code and upon County approval of the project and prior to issuance of the project building permits, approved site plans shall be submitted for the District’s review and approval. Also, the project shall annex to Community Facilities District No. 2010-01 of CalFire. These requirements, included as Project Notes, will be addressed through Site Plan Review recommended as a Condition of Approval.

2. Police protection; or

3. Schools; or

4. Parks; or

5. Other public facilities?

FINDING: NO IMPACT:

The project will not impact existing public services, nor will it result in the need for additional public services related to schools, parks or police protection by the Fresno County Sheriff’s Office.

## XVI. RECREATION

Would the project:

- A. Increase the use of existing neighborhood and regional parks or other recreational facilities such that substantial physical deterioration of the facility would occur or be accelerated; or



- B. Include recreational facilities or require the construction or expansion of recreational facilities, which might have an adverse physical effect on the environment?

FINDING: NO IMPACT:

The project will not induce population growth which may require construction of new or expanded recreational facilities in the area.

## XVII. TRANSPORTATION

Would the project:

- A. Conflict with a program, plan, ordinance or policy addressing the circulation system, including transit, roadway, bicycle and pedestrian facilities?

FINDING: LESS THAN SIGNIFICANT IMPACT WITH MITIGATION  
INCORPORATED:

The project will not conflict with any policy addressing the circulation system, including transit, roadway, bicycle and pedestrian facilities. The project site is located approximately 6.4 miles east of the City of Coalinga along Jayne Avenue, which is designated as a rural expressway in the County General Plan. The project area is comprised of limited sporadic farming, is rural in nature, and is not planned for any transit, bicycle, or pedestrian facilities per the Transportation and Circulation Element of the Fresno County General Plan.

The Design Division of the Fresno County Department of Public Works and Planning reviewed the subject proposal and required a traffic impact study to determine the project's impacts to County Roads and Intersections. A Traffic Impact Analysis (TIA) was prepared for the project by JBL Traffic Engineering, Inc. and dated November 15, 2019.

According to the TIA, presently, all study intersections and segments operate at an acceptable Level of Service (LOS) during both peak periods. The project was analyzed for the location of the proposed access points relative to the existing local roads within the project vicinity. The proposed project driveways are located at points that minimize traffic operational impacts to the existing roadway network. At buildout, the project is estimated to generate a maximum of 4,794 daily trips, 248 AM peak-hour trips and 140 PM peak-hour trips.

Furthermore, according to the TIA, Under Near Term Year 2025 and Cumulative Year 2039 plus Project Traffic Conditions, all study intersections and segments are projected to operate at an acceptable LOS during both peak periods. However, traffic at the Interstate 5 and Jayne Avenue interchange should be observed to ensure that the project has no traffic impacts. If the impacts are observed, the TIA recommends that a transportation management plan shall be prepared to alleviate such impacts.

Regarding queuing analysis, the TIA recommends that the project shall add an eastbound left-turn lane and transitions thereof at the intersection of Patron Access Driveway and Jayne Avenue. The Design Division and Road Maintenance and Operations Division of the Fresno County Department of Public Works and Planning concurred with the TIA's recommendations for a left-turn lane. The project will adhere to the following Mitigation Measure to mitigate any traffic-related impacts on Jayne Avenue.

\* **Mitigation Measure:**

1. *Prior to occupancy being granted to the proposed facility, the project proponent shall obtain the necessary right-of-way, design, and construct an eastbound left-turn lane of such length recommended by a traffic engineer and approved by the County on Jayne Avenue into the patron access driveway at the developer's expense. Additional pavement construction and dedication of road right-of-way to the County may be required for the widening of Jayne Avenue to accommodate the left-turn lane. Design documents and an encroachment permit application shall be submitted to the Road Maintenance and Operations Division for approval prior to construction.*

The California Department of Transportation (Caltrans) concurred with the TIA's recommendation for a Traffic Management Plan (TMP). The project will adhere to the following Mitigation Measure related to the TMP:

\* **Mitigation Measure:**

1. *Should traffic impacts be observed for either the northbound or southbound off-ramp at the Interstate 5/Jayne Avenue interchange, the project proponent shall prepare a transportation management plan to alleviate such impacts. The plan, prior to its implementation, shall be reviewed and approved by the California Department of Transportation (Caltrans).*

- B. Be in conflict or be inconsistent with the California Environmental Quality Act (CEQA) Guidelines Section 15064.3, subdivision (b)?

FINDING: LESS THAN SIGNIFICANT IMPACT:

The subject property is located approximately 6.4 miles east of the City of Coalinga and 7.1 miles southwest of the unincorporated community of Huron.

Should the proposed project be approved, the project site will be developed with vendors' area, restrooms, music platform/sitting area under canopy, fruit/vegetable stalls under canopy, parking spaces, and access drives from the public road (Jayne Avenue).

No facilities like the one proposed by this application are currently available on the west side of Fresno County to serve the residents of the City of Coalinga, unincorporated community of Huron and others. Therefore, it is likely that these communities will

continue driving out of town to other flea markets, swap meets, and farmer's markets located in the City of Fresno, City of Selma, and City of Kerman, thereby adding miles travelled across rural areas of the County. In contrast, it is reasonable to expect that the proposed facility will serve those residing in the vicinity of the project and help reduce total vehicle miles travelled out of town. Given this scenario, staff believes the proposed development would not conflict or be inconsistent with above-noted CEQA Guidelines.

- C. Substantially increase hazards due to a geometric design feature (e.g., sharp curves or dangerous intersections) or incompatible uses (e.g., farm equipment)?

FINDING: LESS THAN SIGNIFICANT IMPACT WITH MITIGATION  
INCORPORATED:

The Road Maintenance and Operations Division of the Fresno County Department of Public Works and Planning reviewed the subject proposal and requires that any fees that might be collected for visitor parking should be done at the check point, leaving the 220-foot-long driveway off Jayne Avenue as a queueing area. To address this possibility, the applicant should develop a traffic management plan (TMP) to show the measures that would be instituted in order to remove any queue from the public road right-of-way. The project will adhere to the following Mitigation Measure relating to the TMP:

\* **Mitigation Measure:**

1. *Prior to the issuance of building permit and at the time of Site Plan Review, the applicant shall develop a Traffic Management Plan (TMP) for review and approval by the Road Maintenance and Operations Division of the Fresno County Department of Public Works and Planning. The TMP shall include a 220-foot-long driveway off Jayne Avenue as a queueing area, excluding visitors checkpoint/fee collection and the existing 60-foot right-of-way north of Jayne Avenue.*

- D. Result in inadequate emergency access?

FINDING: NO IMPACT:

Jayne Avenue, a paved public road, provides direct access to the project site. The initial review of the project by the County Fire Department resulted in no concerns regarding inadequate emergency access to the site. The emergency access will be further analyzed by the Fire Department through subsequent Site Plan Review recommended as a Condition of Approval for the project.

## XVIII. TRIBAL CULTURAL RESOURCES

Would the project:

- A. Cause a substantial adverse change in the significance of a tribal cultural resource, defined in Public Resources Code Section 21074 as either a site, feature, place, cultural landscape that is geographically defined in terms of the size and scope of the landscape, sacred place, or object with cultural value to a California Native American tribe, and that is:
1. Listed or eligible for listing in the California Register of Historical Resources, or in a local register of historical resources as defined in Public Resources Code Section 5020.1(k); or
  2. A resource determined by the lead agency, in its discretion and supported by substantial evidence, to be significant pursuant to criteria set forth in subdivision (c) of Public Resources Code Section 5024.1? (In applying the criteria set forth in subdivision (c) of Public Resource Code Section 5024.1, the lead agency shall consider the significance of the resource to a California Native American tribe.)?

FINDING: LESS THAN SIGNIFICANT IMPACT:

The project site is not located in an area designated as medium sensitive for archeological resources. Pursuant to Assembly Bill (AB) 52, the subject proposal was routed to the Santa Rosa Rancheria Tachi Yokut Tribe, Picayune Rancheria of the Chukchansi Indians, and Dumna Wo Wah Tribal Government offering them an opportunity to consult under Public Resources Code (PRC) Section 21080.3(b) with a 30-day window to formally respond to the County letter. No tribe requested consultation, resulting in no further action on the part of the County. Because the property is moderately sensitive to archaeological resources, a Mitigation Measure has been included in the CULTURAL ANALYSIS section of this report. Implementation of this Mitigation Measure will reduce impact to tribal cultural resources to a less than significant.

## XIX. UTILITIES AND SERVICE SYSTEMS

Would the project:

- A. Require or result in the relocation or construction of new or expanded water, wastewater treatment or storm water drainage, electric power, natural gas, or telecommunications facilities, the construction or relocation of which could cause significant environmental effects?

FINDING: LESS THAN SIGNIFICANT IMPACT:

See discussion in Section VII. E. GEOLOGY AND SOILS above. The project will not result in the relocation or construction of new electric power, natural gas, or telecommunications facilities.

- B. Have sufficient water supplies available to serve the project and reasonably foreseeable future development during normal, dry and multiple dry years?

FINDING: LESS THAN SIGNIFICANT IMPACT:

See discussion in Section X. B. HYDROLOGY AND WATER QUALITY above.

- C. Result in a determination by the wastewater treatment provider which serves or may serve the project that it has adequate capacity to serve the project's projected demand in addition to the provider's existing commitments?

FINDING: LESS THAN SIGNIFICANT IMPACT:

See discussion in Section VII. E. GEOLOGY AND SOILS above.

- D. Generate solid waste in excess of State or local standards, or in excess of the capacity of local infrastructure, or otherwise impair the attainment of solid waste reduction goals; or
- E. Comply with federal, state, and local management and reduction statutes and regulations related to solid waste?

FINDING: LESS THAN SIGNIFICANT IMPACT:

Per the Applicant's Operational Statement, the proposed facility will produce approximately one ton of trash and recyclable solid waste per week. Solid waste for the local landfill will be collected through regular trash collection service, while others will be recycled. All solid waste disposal will adhere to local and state standards and will have a less than significant impact on the holding capacity of local landfills.

## XX. WILDFIRE

If located in or near state responsibility areas or lands classified as very high fire hazard severity zones, would the project:

- A. Substantially impair an adopted emergency response plan or emergency evacuation plan, or telecommunications facilities, the construction or relocation of which could cause significant environmental effects; or
- B. Due to slope, prevailing winds, and other factors, exacerbate wildfire risks, and thereby expose project occupants to pollutant concentrations from a wildfire or the uncontrolled spread of a wildfire; or
- C. Require the installation or maintenance of associated infrastructure (such as roads, fuel breaks, emergency water sources, power lines or other utilities) that may exacerbate fire risk or that may result in temporary or ongoing impacts to the environment; or
- D. Expose people or structures to significant risks, including downslope or downstream flooding or landslides, as a result of runoff, post-fire slope instability, or drainage changes?

FINDING: NO IMPACT:

The project site is not located within or near a State Responsibility Area for wildfire. Also, see discussion in Section XV. A. 1. PUBLIC SERVICES above.

## XXI. MANDATORY FINDINGS OF SIGNIFICANCE

Would the project:

- A. Have the potential to substantially degrade the quality of the environment, substantially reduce the habitat of a fish or wildlife species, cause a fish or wildlife population to drop below self-sustaining levels, threaten to eliminate a plant or animal community, substantially reduce the number or restrict the range of a rare or endangered plant or animal or eliminate important examples of the major periods of California history or prehistory?

FINDING: LESS THAN SIGNIFICANT IMPACT:

Construction and operation of the project may impact sensitive biological and cultural resources. Included Mitigation Measures in Section IV. BIOLOGICAL RESOURCES and Section V. CULTURAL RESOURCES of this report will minimize such impacts to less than significant.

- B. Have impacts that are individually limited, but cumulatively considerable (“cumulatively considerable” means that the incremental effects of a project are considerable when viewed in connection with the effects of past projects, the effects of other current projects, and the effects of probable future projects)?

FINDING: LESS THAN SIGNIFICANT IMPACT:

Each of the projects located within Fresno County has been or would be analyzed for potential impacts, and appropriate project-specific Mitigation Measures are developed to reduce that project’s impacts to less than significant levels. Projects are required to comply with applicable County policies and ordinances. The incremental contribution by the proposed project to overall development in the area is less than significant.

The project will adhere to the permitting requirements and rules and regulations set forth by the Fresno County Grading and Drainage Ordinance, San Joaquin Air Pollution Control District, and California Code of Regulations Fire Code at the time development occurs on the property. No cumulatively considerable impacts relating to Agricultural and Forestry Resources or Air quality were identified in the project analysis.

- C. Have environmental effects which will cause substantial adverse effects on human beings either directly or indirectly?

FINDING: NO IMPACT:

No substantial impacts on human beings, either directly or indirectly, were identified in the analysis.

## CONCLUSION/SUMMARY

Based upon Initial Study No. 7568 prepared for Classified Conditional Use Permit Application No. 3632, staff has concluded that the project will not have a significant effect on the environment. It has been determined that there would be no impacts to mineral resources, population and housing, recreation, or wildfire.

Potential impacts related to agriculture and forestry resources, energy, geology and soils, greenhouse gas emissions, land use and planning, noise, public services, tribal cultural resources, utilities and service systems have been determined to be less than significant.

Potential impacts to aesthetics, air quality, biological resources, cultural resources, **hazards and hazardous materials**, hydrology and water quality, and transportation have been determined to be less than significant with the identified Mitigation Measures.

A Mitigated Negative Declaration is recommended and is subject to approval by the decision-making body. The Initial Study is available for review at 2220 Tulare Street, Suite A, street level, located on the southwest corner of Tulare and "M" Streets, Fresno, California.

EA:  
G:\4360Devs&Pln\PROJSEC\PROJDOCS\CUP\3600-3699\3632\IS-CEQA\CUP 3632 IS wu.doc

File original and one copy with: <b>Fresno County Clerk 2221 Kern Street Fresno, California 93721</b>		Space Below For County Clerk Only.  CLK-2046.00 E04-73 R00-00	
Agency File No: IS 7568	<b>LOCAL AGENCY PROPOSED MITIGATED NEGATIVE DECLARATION</b>		County Clerk File No: <b>E-</b>
Responsible Agency (Name): Fresno County	Address (Street and P.O. Box): 2220 Tulare St. Sixth Floor	City: Fresno	Zip Code: 93721
Agency Contact Person (Name and Title): Ejaz Ahmad, Planner	Area Code: 559	Telephone Number: 600-4204	Extension: N/A
Applicant (Name): Luis Bravo on behalf of Rito Gutierrez	Project Title: Classified Conditional Use Permit Application No. 3632		
Project Description: Allow a flea market with related improvements on an approximately six-acre portion of a 78.18-acre parcel in AE-20 (Exclusive Agricultural; 20-acre minimum parcel size) Zone District. The project is located on the north side of W. Jayne Avenue approximately 2,556 feet west of its intersection with El Dorado Avenue and 6.4 miles east of the nearest city limits of City of Coalinga (23436 W. Jayne Avenue, Coalinga) (Sup. Dist. 4) (APN 073-090-20S).			
Justification for Mitigated Negative Declaration: Based upon the Initial Study (IS 7568) prepared for Classified Conditional Use Permit Application No. 3632, staff has concluded that the project will not have a significant effect on the environment.  No impacts were identified related to mineral resources, population and housing, recreation, or wildfire.  Potential impacts related to agriculture and forestry resources, energy, geology and soils, greenhouse gas emissions, land use and planning, noise, public services, tribal cultural resources, utilities and service systems have been determined to be less than significant.  Potential impacts related to aesthetics, air quality, biological resources, cultural resources, hazards and hazardous materials, hydrology and water quality, and transportation have been determined to be less than significant with the included Mitigation Measures.  The Initial Study and Mitigated Negative Declaration (MND) is available for review at 2220 Tulare Street, Suite A, Street Level, located on the southeast corner of Tulare and "M" Street, Fresno, California.			
FINDING: The proposed project will not have a significant impact on the environment.			
Newspaper and Date of Publication: Fresno Business Journal – January 13, 2020		Review Date Deadline: Planning Commission – February 13, 2020	
Date: January 10, 2020	Type or Print Name: Marianne Mollring, Senior Planner	Submitted by (Signature):	

State 15083, 15085

County Clerk File No.: \_\_\_\_\_

**LOCAL AGENCY  
MITIGATED NEGATIVE DECLARATION**

G:\4360Devs&amp;Pln\PROJSEC\PROJDOCS\CUP\3600-3699\3632\IS-CEQA\CUP3632 MND Draft.docx

**EXHIBIT 8**