



County of Fresno

DEPARTMENT OF PUBLIC WORKS AND PLANNING
STEVEN E. WHITE, DIRECTOR

Planning Commission Staff Report Agenda Item No. 4 September 12, 2019

SUBJECT: Variance Application No. 4054

Allow waiver of the public road frontage requirement for all seven lots within Tract No. 3057, and allow the construction of a six-foot tall vehicle gate, a 6-foot tall pedestrian gate, and a 6-foot tall fence, where a maximum of three feet is allowed, within the front-yard setback of Lot Nos. 1 and 7 of said tract, in the R-R (Rural Residential, two-acre minimum parcel size) Zone District.

LOCATION: The subject parcels (Tract No. 3057) are located on East Cole Avenue on the east side of North Fowler Avenue, between East Teague Avenue and the Enterprise Canal, easterly, northerly, and westerly adjacent to the nearest city limits of the City of Clovis, and within the City of Clovis Sphere of Influence (SUP. DIST. 5) (APN's 559-012-21, 22, 23, 24, 25, 26, and 27).

OWNERS: Joseph and Ashley Coelho; Daniel J. and Deborah S. Mueller, Trustees; Thomas L. and Linda L. Bell, Trustees; Kourosh and Golnaz Malakan, Trustees; Casey A. and Jamie R. Belmont; Erik Ibach and Jill Marie Lott; and Ronald A. and Carole D. Day

APPLICANT Thomas L. Bell

STAFF CONTACT: Jeremy Shaw, Planner
(559) 600-4207

Marianne Mollring, Senior Planner
(559) 600-4569

RECOMMENDATION:

- Deny Variance No. 4054; and
- Direct the Secretary to prepare a Resolution documenting the Commission's action.

EXHIBITS:

1. Conditions of Approval and Project Notes
2. Location Map
3. Existing Zoning Map
4. Existing Land Use Map
5. Site Plans and Detail Drawings
6. Approved Variances Map
7. Applicant’s Findings

SITE DEVELOPMENT AND OPERATIONAL INFORMATION:

Criteria	Existing	Proposed
General Plan Designation	Rural Density Residential in the County-Adopted Clovis Community Plan	No change
Zoning	R-R (Rural Residential, two-acre minimum parcel size) Zone District	No change
Parcel Size	Parcel sizes in Tract No. 3057 range from 2.03 acres to 2.70 acres	If the Variance is approved, and the public right-of-way for East Cole Avenue is vacated by the Board, the property lines for each lot within Tract No. 3057 would be extended to the center of the road, which will become a private easement for the exclusive use of the properties within the tract. The removal of the public right-of-way will increase the individual lot sizes by 30 feet in depth across the existing width of each lot. A cross access agreement will be required so that each property will retain access rights, as required in Section 820.5 of the Zoning Ordinance (Property Development Standards) for the Rural Residential Zone District.

Criteria	Existing	Proposed
Project Site	Lots 1 through 7 of Tract No. 3057 (APN's 559-012-21, 22, 23, 24, 25, 26, and 27)	No change
Structural Improvements	Single-family residences and accessory buildings	A 16-foot-wide by 6-foot-tall vehicle gate with a remote call box and 4-foot-wide by 6-foot-tall pedestrian access gate across East Cole Avenue, and a six-foot-tall fence on both sides of the gates within Lot Nos. 1 and 7 of Tract 3057 The gates will be located approximately 57 feet east of the nearest right-of-way of North Fowler Avenue.
Nearest Residence	North: Approximately 185 feet South: Approximately 1,000 feet East: Approximately 115 feet West: Approximately 60 feet	No change
Surrounding Development	North: Residential East: Residential South: Rural Residential West: Rural Residential	No change

EXISTING VIOLATION (Y/N) AND NATURE OF VIOLATION: N

ENVIRONMENTAL ANALYSIS:

It has been determined that the project is categorically exempt from the provisions of the California Environmental Quality Act (CEQA) guidelines pursuant to Section 15061(b)(3), and that the proposed project will not have a significant effect on the environment and is not subject to CEQA.

PUBLIC NOTICE:

Notices were sent to 102 property owners within 600 feet of the subject parcel, exceeding the minimum notification requirements prescribed by the California Government Code and County Zoning Ordinance.

PROCEDURAL CONSIDERATIONS:

A Variance (VA) may be approved only if four Findings specified in the Fresno County Zoning Ordinance, Section 877 are made by the Planning Commission.

The decision of the Planning Commission on a Variance Application is final, unless appealed to the Board of Supervisors within 15 days of the Commission's action.

BACKGROUND INFORMATION:

Tract No. 3075 was recorded on March 2, 1981, creating seven lots ranging between 2.03 and 2.65 acres in size, including the dedication of road right-of-way for East Cole Avenue across the parcel frontages of lot Nos. 1 and 7 for street purposes, and the dedication of an easement for street purposes, which provides for access to the seven lots, and for public utility easements. East Cole Avenue is classified as a Local road, and was designed as an approximately 897-foot (0.17 mile)-long cul-de-sac, with a 60-foot right-of-way, and no other outlets.

This Variance request proposes to allow the waiver of the public road frontage requirement for the seven parcels accessed by East Cole Avenue, located east of Fowler Avenue, within Tract No. 3057, and allow for the construction of vehicle and pedestrian access gates within the front-yard setback area of Lot Nos. 1 and 7, with the intent of restricting public (non-resident) access to that section of East Cole Avenue. In order to restrict public access to Cole Avenue, the public right-of-way must be vacated by the County Board of Supervisors. A Feasibility Study and Vacation Application were submitted to the Fresno County Department of Public Works and Planning on October 31, 2016, and a subsequent Feasibility Study was completed on February 22, 2017, which established the requirements for the road vacation.

If this Variance is approved, the road vacation must be approved by the Board of Supervisors before construction of the gated entry. Additionally, per the California Streets and Highways Code (SHC) the Applicant will be required to demonstrate that continued maintenance of the road has been provided for through the formation of a funding mechanism acceptable to the County, prior to the vacation being scheduled for a Board hearing. Reciprocal cross access agreements authorized by all property owners affected must be completed.

Since 2001, there have been three similar variances approved within 15 miles of the subject property that allowed for the waiver of the public road frontage requirement and/or the vacation of public right-of-way of a County-maintained road. The approved variances are detailed in the following table.

Application/Request	Date of Action	Staff Recommendation	Final Action
VA No. 3714: Waive the public road frontage for all 9 lots within Tract No. 1302 fronting on W. Morris Avenue, and allow a six-foot-tall gate and fence within the front and street side-yard setbacks for two lots in the R-1-AH Zone District	12/20/2001	Denial	Denied by Planning Commission
	1/29/2002	Denial	Approved by Board of Supervisors
VA No. 3872: Allow the creation of four parcels without public road frontage in the R-R Zone District	8/28/2008	Approval	Approved by Planning Commission

VA No. 3956: Waive the public road frontage requirement for parcels 3 and 4 of Parcel Map No. 7873 in the R-R Zone District	2/06/2014	Denial	Approved by Planning Commission
---	-----------	--------	---------------------------------

DISCUSSION:

Findings 1 and 2: *There are exceptional or extraordinary circumstances or conditions applicable to the property involved which do not apply generally to other property in the vicinity having the identical zoning classification; and*

Such variance is necessary for the preservation of a substantial property right of the applicant, which right is possessed by other property owners under like conditions in the vicinity having the identical zoning classification.

	Current Standard:	Proposed Operation:	Is Standard Met (y/n)
Setbacks	<u>R-R Zone District</u> Front: 35 feet Side: 20 feet Rear: 20 feet	<u>Parcel 1</u> Six-foot-tall gate within the front-yard setback <u>Parcel 7</u> Six-foot-tall gate within the front-yard setback	No No
Parking	One parking space covered or uncovered for each dwelling unit	No change	Yes
Lot Coverage	No requirements	No change	Yes
Space Between Buildings	Accessory buildings, detached or connected to a main building by a breezeway roof, shall be a minimum of 6 feet from the main building. Where an accessory building is used for garage purposes and located within the area defined by the side lines of any main building, the garage shall be not less than 25 feet from the main building. All structures housing livestock and poultry shall be located a minimum of forty (40) feet from all buildings used for human habitation, twenty-five feet from side and rear property lines, and one hundred feet from front property lines.	No change	Yes

	Current Standard:	Proposed Operation:	Is Standard Met (y/n)
Wall Requirements	No requirements	No change	N/A
Septic Replacement Area	100 percent	No change	Yes
Water Well Separation	Septic tank: 50 feet Disposal field: 100 feet Seepage pit/cesspool: 150 feet	No change	N/A

Reviewing Agency/Department Comments:

Fresno County Department of Public Health, Environmental Health Division; Development Engineering Section of the Fresno County Department of Public Works and Planning: No comment.

Fresno Metropolitan Flood Control District: Any drainage and grading plan shall be reviewed and approved by the District prior to approval by the County.

Design Division of the Fresno County Department of Public Works and Planning: Staff recommends a Condition of Approval requiring that property owners of Tract No. 3057 maintain the road condition at an adequate level to support daily use. The property owners should not allow the road to fall into disrepair. Should emergency services need to gain access to the area, the roadway must support safe ingress and egress of emergency vehicles and equipment.

Road Maintenance and Operations Division of the Fresno County Department of Public Works and Planning: The proposed gate cannot be installed until the vacation of the road is complete, including the reciprocal cross access agreements.

Development Engineering Section of the Department of Public Works and Planning: Cole Avenue is classified as a Local road with an existing 60-foot right-of-way from its intersection with Fowler Avenue to the end of Cole Avenue, per Tract Map No. 3057. The minimum width for a Local road right-of-way is 60 feet. Cole Avenue is a County-maintained road, and records indicate that this section of Cole Avenue, from its intersection with Fowler Avenue to the end of the road, has an Average Daily Traffic count of 200, a paved width of 24.5 feet, an unknown structural section, and is in fair condition.

Fowler Avenue is classified as an Arterial road in the County General Plan, with an existing 53-foot right-of-way east of the section line along the parcel frontages, per the Plat Book. The minimum width for an Arterial road right-of-way east of the section line is 53 feet. Fowler Avenue is a County-maintained road, and records indicate that this section of Fowler Avenue has an Average Daily Traffic count of 7,000, a paved width of 32.4 feet, a structural section of 0.25 feet asphaltic concrete, and is in very good condition.

City of Clovis Engineering Division: The Applicant shall obtain an encroachment permit from the City for any work performed within the City's right-of-way easements.

For gated developments, the Applicant shall provide ample vehicle stacking area outside the travel lanes of Fowler Avenue that will allow vehicles to wait while other vehicles are accessing the security gate control panel. The Applicant shall design a turnaround to allow vehicles unable to enter the gate to return to the street without backing up. The Applicant shall also provide the Solid Waste Division with remote controls to allow access for all solid waste and recycling service vehicles.

East Cole Avenue, east of Fowler Avenue, shall be private, allowing for two-way traffic with no parking on either side. The minimum travel width shall be 25 feet, with a clear width of 30 feet. For two-way traffic with parking on one side, the minimum travel width shall be 32 feet. For two-way traffic with parking on both sides, the minimum travel width shall be 36 feet.

The Applicant shall provide for the abandonment of East Cole Avenue east of Fowler Avenue. The abandonment shall retain a public utility easement for existing and future utilities.

For new on-site ADA paths of travel that connect to City sidewalks, the Applicant shall replace enough of the sidewalk to provide a compliant landing with appropriate transitions to existing sidewalk grades.

City of Clovis Fire Department: Gate plans must be approved by the fire department prior to construction. Gates shall be of the sliding, swinging, or cross-arm type. When the gate is open, there cannot be any obstruction due to the overhead cross arms, braces or other structures. Overhead clearance of a minimum of 14 feet shall be provided. When open, gates shall provide a clear width of not less than 14 feet for one-direction travel or 20 feet for gates with two-way travel.

The proposed access gate shall be installed with the following features: A lock box with a Best padlock, according to the Fire Department specifications. The entrance and exit gates shall default to an open position and remain open in the event of a power failure at residential developments. A manual gate release shall be provided and accessible for emergency use. All vehicle gates for developments containing dwellings or as required by the Fire Department, shall be equipped with an approved Class II modulated light detection system capable of receiving a modulated frequency of 14.035 Hz, plus or minus 0.250 Hz. The detection system shall be installed according to the manufacturer's specifications. The light detection system shall be installed to operate from any angle of approach by Clovis Fire Department Emergency Vehicles. Multiple light detection sensors may be required to be installed to allow access from different angles of approach. All light sensors are required to be tested by the Clovis Fire Department for approval.

All entrance and exit gates, when made active, shall move from completely closed to fully open, taking no more than 15 seconds. Once the gate is activated via the detection system or lock box, the gate shall remain open for a minimum of 10 seconds. All electrical devices shall be UL listed. All gates shall open automatically when a vehicle is prepared to exit the area.

Developments containing dwellings shall also provide a pedestrian gate in the area of the main gate that can be opened from the inside without a key or special knowledge. Other pedestrian gates may be required. Fire Department approval must be obtained prior to gate entering operation. Approval is granted only after passing a final inspection by the Fire Department.

Fresno Irrigation District: The District's requirements have been met; FID has no other concerns with this project.

Fresno Metropolitan Flood Control District (FMFCD): The District recommends that the County require a temporary on-site storm water storage facility for any additional development or street improvements. Said facility should be located and constructed so that once permanent FMFCD facilities become available, drainage can be directed to the street.

Analysis:

In support of Finding 1, the Applicant states that development within the City of Clovis to the north and poor traffic patterns have resulted in East Cole Avenue being used as a u-turn area for residents who reside north of the Enterprise Canal, which has resulted in numerous accidents at the intersection of E. Cole and Fowler. Additionally, vehicles speed on East Cole Avenue seeking an outlet, despite the posted sign indicating that this section of E. Cole Avenue is not a through street. There are a number of children residing in the Tract, for which this situation has created a safety and traffic hazard.

Additionally, in support of Finding 1, the Applicant's Findings assert that due to the subject Tract No. 3057 being substantially surrounded by the City of Clovis, this creates an exceptional and extraordinary circumstance, and that additional residential development within the City will exacerbate the situation.

Regarding Finding 1, staff acknowledges that Tract 3057 does indeed abut the City of Clovis on three sides (north, west and east), and staff also acknowledges that the existence of the Enterprise Canal along the northern border of Lot Nos. 1 and 2 does create a limitation on the usable area of those two lots. The residential development in Clovis, particularly the tract to the north of the Enterprise Canal and new development on the west side of Fowler Avenue, is situated such that vehicles exiting that neighborhood and wishing to travel north on Fowler Avenue would have to make a u-turn at Cole Avenue. The intersection of East Cole and Fowler provides the only place along that segment of North Fowler, between the Enterprise Canal and East Teague Avenue, where a u-turn is feasible. Staff notes that the residential development to the north of the canal and on the east side of Fowler does provide a turn lane from the southbound side of Fowler for vehicles entering the development or making a u-turn to go north.

While the traffic pattern along Fowler Avenue adjacent to the subject development does create a situation whereby drivers may be inclined to utilize the East Cole Avenue intersection as a u-turn point, staff was unable to identify any extraordinary or exceptional circumstances or physical characteristics relating to the subject development or generally to the individual properties therein that would justify the need for a Variance, as left turns and u-turns are typically located on Arterial streets at street intersections.

Additionally, staff does not concur that the development's proximity to the boundaries of the City of Clovis in and of itself creates an exceptional circumstance. The increase in residential density and traffic from surrounding development is considerable but not unusual for property located within a city sphere of influence.

In support of Finding 2, the Applicant states that the Variance request to allow the waiver of public road frontage requirement, and a reduction of the front-yard setbacks for Lot Nos. 1 and 7, for the ultimate purpose of vacating the public right-of-way on East Cole Avenue is necessary in order to preserve the rural residential character of the neighborhood as the City's residential development encroaches, and to protect against the potential increase in crime and other unwanted activity resulting from the higher residential densities. This section of East Cole Avenue has no street lights and is lined by many mature trees and other vegetation, which may provide visual cover for such undesirable activities.

A consideration in addressing Findings 1 and 2 is whether there are alternatives available that would avoid the need for the Variance. In this case, there are no other options which would achieve the Applicant's stated intention, which is to restrict public access to East Cole Avenue for safety and security purposes. All properties within the Rural Residential Zone District are subject to the same property development standards, particularly where road frontage is concerned. As noted previously, there have been several other variances approved which allowed for a waiver of public road frontage for the express purpose of subsequent vacating of the public right-of-way, and the request for a waiver or reduction of road frontage requirements is not in itself uncommon. However, staff does not believe that the lack of a private road with a security gate constitutes the deficit of a substantial property right requiring a Variance to fulfill.

Based on the above analysis, staff does not believe that there are exceptional or extraordinary circumstances particular to the subject development, nor that there is a substantial property right at issue which would require a variance to be preserved, and is therefore unable to make Findings 1 and 2.

Recommended Conditions of Approval:

None.

Conclusion:

Findings 1 and 2 cannot be made.

Finding 3: *The granting of the Variance will not be materially detrimental to the public welfare or injurious to property and improvement in the vicinity in which the property is located.*

Surrounding Parcels				
	Size:	Use:	Zoning:	Nearest Residence:
North	N/A	Single-Family Residential	City of Clovis (R-1)	Approximately 120 feet
South	4.18 acres 4.35 acres 2.04 acres	Single-Family Residential Single-Family Residential Single-Family Residential	Fresno County (Rural Residential)	Approximately 25 feet Approximately 260 feet Approximately 45 feet
East	N/A	Single-Family Residential Single-Family Residential	City of Clovis (R-1-AH)	Approximately 65 feet
West	6.73 acres 2.42 acres	Single-Family Residential Single-Family Residential	City of Clovis (R-1)	Approximately 100 feet Approximately 210 feet

Reviewing Agency/Department Comments:

Fresno County Fire Protection District: No requirements at this time.

No other comments specific to land use compatibility were expressed by any reviewing agencies or departments.

Analysis:

In support of Finding 3, the Applicant states that the granting of the Variance would allow for the vacation of the public right-of-way for East Cole, subsequent construction of a private gated entrance for the purpose of limiting access to the seven parcels of Tract No. 3057, and would not have a detrimental effect on surrounding properties. This section of East Cole Avenue has no other outlet and only provides access to this development. The Applicant also states that should the Variance be approved, there would be no impacts to traffic, and the gate would be constructed in such a way as to avoid impacts to the flow of traffic on Fowler Avenue that may be caused by vehicles queuing at the entry gate. Additionally, the design of the gate entrance will allow for vehicles to make u-turns safely, and in effect create a remedy for the ongoing problem of vehicles making an unsafe u-turn at the intersection of Cole and Fowler in order to go north on Fowler Avenue.

Staff concurs that the installation of the gate and restriction of public access to the development on East Cole Avenue would not likely result in any adverse impact on the public welfare or surrounding property, including the abutting roadway, with adherence to the included Conditions of Approval. With regard to the effects on traffic from the installation of the gate, the number of vehicles that currently utilize East Cole to make a u-turn to go north on Fowler is unknown, and any impact on such occurrences would be speculative, without supporting traffic data. In this case no traffic study was required.

If this Variance is approved, the section of East Cole Avenue serving the seven parcels of Tract No. 3057 east of Fowler Avenue would be proposed for vacation of the public right-of-way, requiring an additional review process by the Department of Public Works and Planning, before being scheduled for a hearing before the Board of Supervisors. If the Board approves the vacation, the property lines of the seven parcels would extend to the center of the road, requiring reciprocal cross access agreements between the affected property owners. The road vacation process must be complete before permits will be issued for construction of the gate. The proposed access gate will be required to have adequate turnaround area for vehicles that are denied access to the development, so that they do not have to back up onto Fowler Avenue.

Based on this analysis, staff believes that this proposal will not have an adverse or detrimental effect on surrounding property; therefore, Finding 3 can be made.

Recommended Conditions of Approval:

See recommended Conditions of Approval attached as Exhibit 1.

Conclusion:

Finding 3 can be made.

Finding 4: That the proposed development is consistent with the General Plan.

Relevant Policy:	Consistency/ Considerations:
<p>General Plan Policy LU-G.1 The County acknowledges that the cities have primary responsibility for planning within their LAFCo-adopted spheres of influence, and are responsible for urban development and the provision of urban services within their spheres of influence</p>	<p>The City of Clovis Planning Division reviewed this project and had no concerns with this proposal to allow the construction and installation of vehicle and pedestrian gates across East Cole Avenue and vacation of the public right-of-way</p> <p>The City of Clovis Engineering Division comments have been included as Project Notes</p> <p>The City of Clovis Fire Department requirements have been included as Conditions of Approval</p>
<p>General Plan Policy HS.B.5 The County shall require development to have adequate access for fire and emergency vehicles and equipment.</p>	<p>Conditions of approval have been included that would require the proposed gate to meet access standards of both the City of Clovis Fire Department and the Fresno County Fire Protection District</p>

Reviewing Agency Comments:

Zoning Section of the Fresno County Department of Public Works and Planning: No comment.

Policy Planning Section of the Fresno County Department of Public Works and Planning: The subject parcels are located within the City of Clovis Sphere of Influence and are designated as Rural Density Residential in the County-Adopted Clovis Community Plan.

Water and Natural Resources Division of the Fresno County Department of Public Works and Planning: No comment.

No other comments specific to General Plan Policy were expressed by reviewing agencies or departments.

City of Clovis Planning and Development Department: The subject property is located within the Dry Creek Preserve, is designated for rural residential use, and is currently developed.

Analysis:

In support of Finding 4, the Applicant states that the subject property is within the City of Clovis Dry Creek Preserve Master Plan area, and that the property owners have negotiated an annexation agreement with the City which will preserve the rural residential designation of the property after annexation. After review of this proposal, the City of Clovis did not identify any conflicts with any City-adopted land use plans. Approval of this Variance with included conditions would not conflict with any of the provisions of the County General Plan.

The subject property is designated medium-low density residential in the Clovis Community Plan within the City of Clovis Sphere of influence and bounded on the north, east, and west by the City of Clovis. The subject property, Tract No. 3057, is located within the City's Dry Creek Preserve Master Plan Area, and designated as Rural Residential. The General Plan does not specifically address road frontage requirements. Staff is currently not aware of plans for annexation of the area around the subject parcel by the City.

The section of East Cole Avenue at issue is classified as a Local road, which in the General Plan states that Local roads provide direct access to abutting property and connect with other Local roads, Collectors, Arterials and Expressways. Local roads are typically developed as two-lane undivided roadways, and access to abutting private property and intersecting streets shall be permitted. In this case, East Cole provides access to the subject development from North Fowler Avenue, classified as an Arterial, with an ultimate right-of-way width of 106 feet. The proposed access gate will be required to be outside of that ultimate right-of-way.

Staff does not believe this proposal would conflict with the circulation and transportation element, nor be inconsistent with the overall objectives of the General Plan or the County-adopted Clovis Community Plan. The General Plan does not contain policies that specifically address a road frontage requirement, just that residential subdivisions must provide internal and external street systems, and adequate access for fire and emergency vehicles and equipment.

Staff believes that the proposal to vacate the public right-of-way, install a gate, and essentially privatize East Cole Avenue would still provide for property owners, emergency services and utility services to safely access the properties within the tract without impacting the efficiency of the abutting segment of North Fowler Avenue or the overall circulation system.

Based on the above analysis, and with adherence to the included Conditions of Approval and Project Notes, staff believes that the proposal to allow the waiver of the public frontage is consistent with the objectives of the General Plan; therefore, Finding 4 can be made.

Recommended Conditions of Approval:

See recommended Conditions of Approval attached as Exhibit 1.

Conclusion:

Finding 4 can be made.

PUBLIC COMMENT:

None.

CONCLUSION:

Based on the factors cited in the analysis, and due to the inability to make Findings 1 and 2, staff believes that the required Findings for granting the Variance cannot be made and therefore recommends denial of Variance No. 4054.

PLANNING COMMISSION MOTIONS:

Recommended Motion (Denial Action)

- Move to determine that the required Findings cannot be made and move to deny Variance No. 4054; and
- Direct the Secretary to prepare a Resolution documenting the Commission's action.

Alternative Motion (Approval Action)

- Move to determine the required Findings can be made (state basis for making the Findings), and move to approve Variance No. 4054, subject to the Conditions of Approval and Project Notes listed in Exhibit 1; and
- Direct the Secretary to prepare a Resolution documenting the Commission's action.

Recommended Conditions of Approval and Project Notes:

See attached Exhibit 1.

JS:ksn

G:\4360Devs&PIn\PROJSEC\PROJDOCS\VA\4000-4099\4054\SR\VA 4054 SR.docx

**Variance Application (VA) No. 4054
Conditions of Approval and Project Notes**

Conditions of Approval	
1.	Development shall be in accordance with the site plan as approved by the Planning Commission.
2.	Prior to issuance of permits for construction of the gates, the Applicant shall demonstrate that provision for continuing maintenance of the private access easement, formerly East Cole Avenue, has been made by a property owners' association or other method acceptable to the Department of Public Works and Planning.
3.	Prior to the issuance of permits for gate construction, the road vacation process shall be completed, including the reciprocal cross access agreements, to provide access to the individual lots within Tract No. 3057.
4.	<p>The entrance gates shall be constructed and maintained in accordance with the requirements of the Fresno County Fire Protection District and the City of Clovis Fire Department.</p> <ul style="list-style-type: none"> a) If the vehicle entrance gate is a swing type, the gate shall open inward toward the development. b) The call box or actuator shall be located a minimum of 25 feet from the public right-of-way of North Fowler Avenue. c) When gate is open there can be no obstruction due to overhead cross-arms, braces or other structures, and gate shall provide an overhead clearance of a minimum of 14 feet. When open, gate shall provide a clear width of not less than 14 feet for one direction travel, or 20 feet for two direction travel.
5.	<p>For electronically operated gates: A lock box with a Best Lock Company padlock Model No. 21B722-L, and must have a CX-1 core, and not an X-1 core.</p> <ul style="list-style-type: none"> a) The lock box shall be a Door King lock box Model 1400 or similar product. b) The color of the box shall be red with FIRE DEPT painted on the door. c) The entry and exit gates are to remain open while lock box door is open. d) The lock box shall be installed in an area that is easily located but protected from vehicular damage. e) The lock box shall be locked using a Best Lock Company padlock with the specifications previously listed.
6.	<p>For non-electric gates – vehicle and pedestrian:</p> <ul style="list-style-type: none"> a) A Best Lock Company padlock with CX-1 core shall be used. b) A lock box or rapid entry box shall be installed. c) Non-electric vehicle gates will require an “Emergency Access No Parking” sign installed on both sides of the gate. Refer to Clovis Fire Department standard No. 1. d) Emergency pedestrian gates shall require a sign on both sides. The sign shall be made of aluminum and read “FIRE DEPT ACCESS” with lettering a minimum of one and one-half inches tall that contrasts with the background, which shall be white and reflective.

Conditions of Approval reference recommended Conditions for the project.

EXHIBIT 1

Notes

The following Notes reference mandatory requirements of Fresno County or other Agencies and are provided as information to the project Applicant.

1.	The approval of this Variance will expire one year from the date of approval unless the required road vacation is completed and reciprocal cross access agreements completed and recorded.
2.	If not already present, 30-foot by 30-foot corner cutoffs shall be improved for sight distance purposes at the intersection of East Cole Avenue and North Fowler Avenue.
3.	An engineered grading and drainage plan with grading permit shall be required. Improvement plans shall be submitted to the Fresno County Department of Public Works and Planning, Development Engineering Section for review and approval. Any work proposed within the right-of-way of North Fowler Avenue shall require an encroachment permit from the Fresno County Department of Public Works and Planning, Road Maintenance and Operations Division.
4.	A Grading Permit or Voucher shall be required for any grading that has been done without a permit and any grading associated with future development of the existing and proposed parcel(s).
5.	Any additional runoff generated by development cannot be drained across property lines and must be retained or disposed of per County standards.



JS:ksn

G:\4360Devs&Pln\PROJSEC\PROJDOCS\VA\4000-4099\4054\SR\VA 4054 Conditions & PN (Ex 1).docx

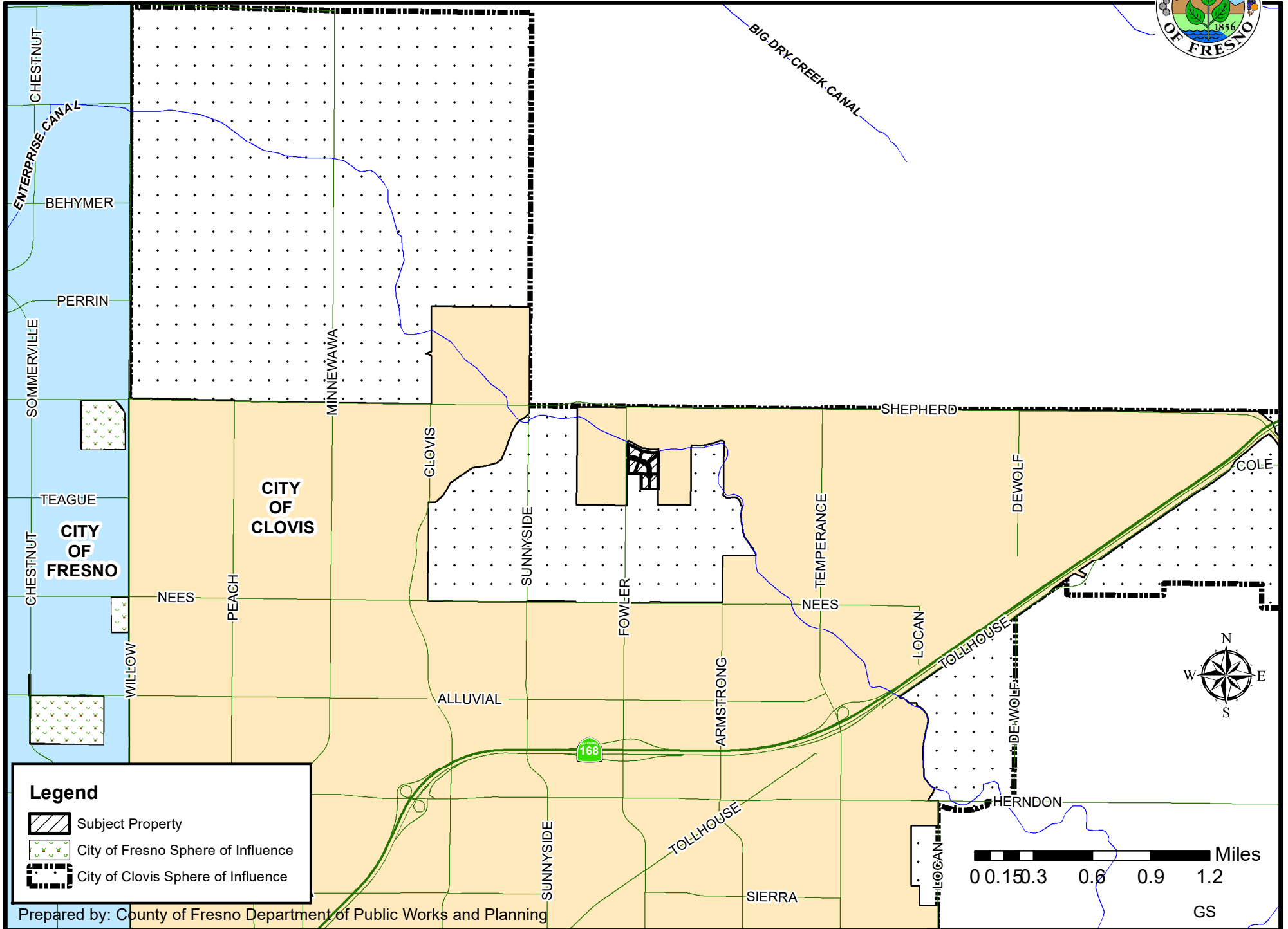
LOCATION MAP



Legend

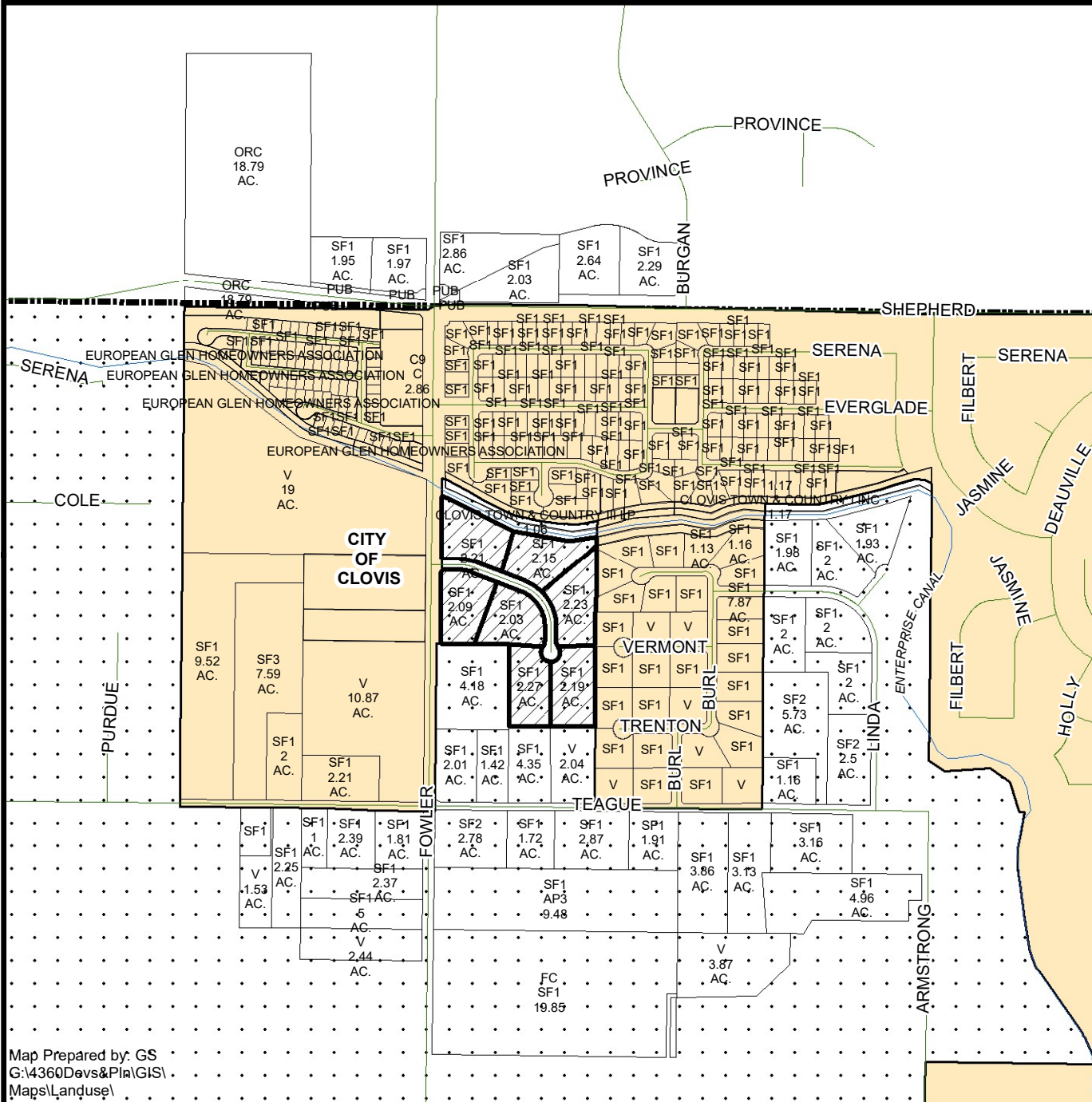

-  Subject Property
-  City of Fresno Sphere of Influence
-  City of Clovis Sphere of Influence

EXISTING LAND USE MAP



LEGEND	
AP1	- APARTMENT
C#	- COMMERCIAL
FC	- FIELD CROP
ORC	- ORCHARD
PUB	- PUBLICLY OWNED
SF#	- SINGLE FAMILY RESIDENCE
V	- VACANT

Legend

-  Subject Property
-  City of Clovis Sphere of Influence

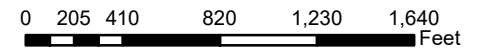
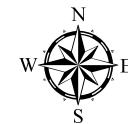

Department of Public Works and Planning
Development Services Division

Map Prepared by: GS
G:\4360D\evs&Plan\GIS\Maps\Landuse\

FOWLER AVE

CENTER LINE

POSSIBLE ROAD EXPANSION TO 4 LANES

COLE AVE

EXISTING 24' COLE AVE

53' EASEMENT

ASPHALT EXTENSION 8 FEET

ASPHALT EXTENSION 8 FEET

60' to CENTER LINE
CALL BOX
50' to GATE

40' TURN AROUND

40'

24'

16' GATE

SWING

4' PEDESTRIAN GATE

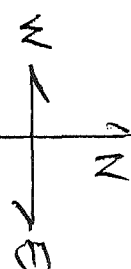

1/8" = 1'

EXHIBIT 5

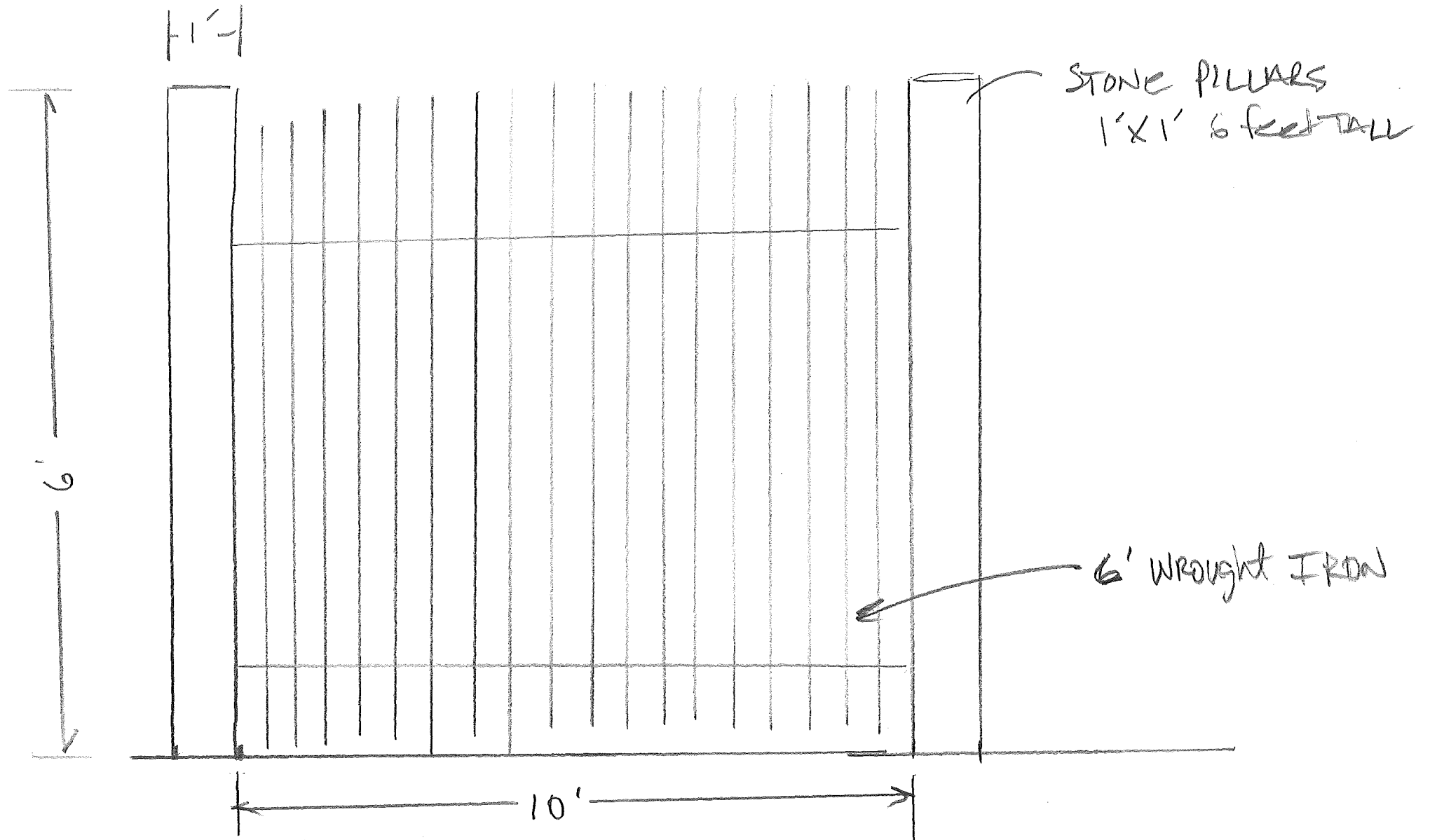

$\frac{1}{2}'' = 1'$

RECEIVED
COUNTY OF FRESNO

AUG 15 2018

DEPARTMENT OF PUBLIC WORKS
AND PLANNING
DEVELOPMENT SERVICES DIVISION

COLE AVE GATE DETAIL

$\frac{1}{4}'' = 1'$
SCALE

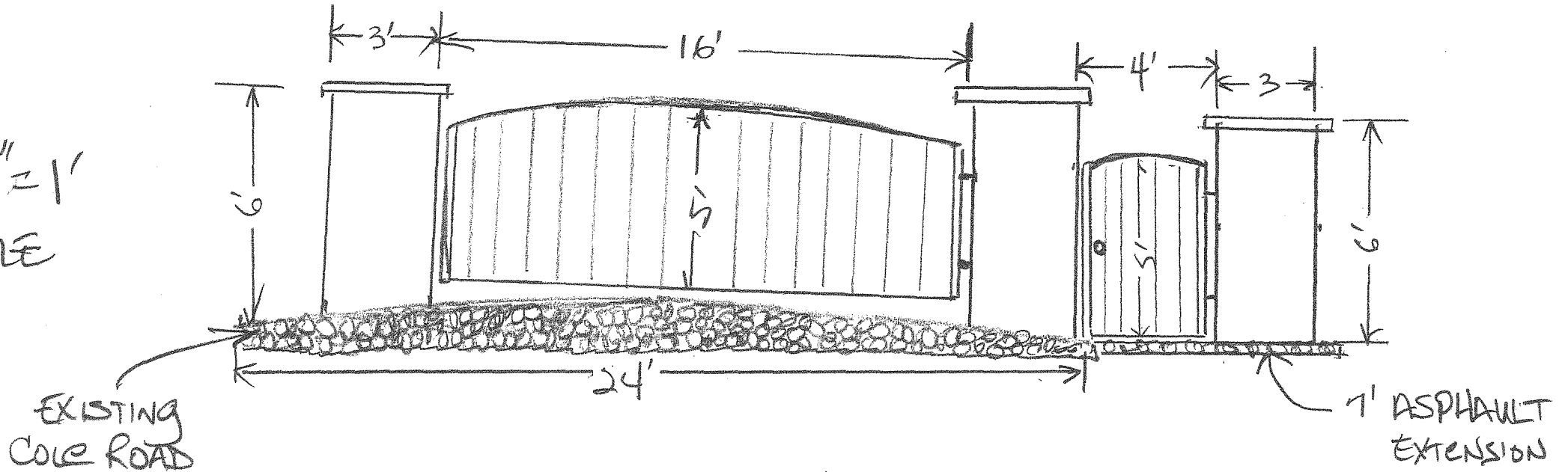

RECEIVED
COUNTY OF FRESNO

AUG 15 2018

DEPARTMENT OF PUBLIC WORKS
AND PLANNING
DEVELOPMENT SERVICES DIVISION

RECEIVED
COUNTY OF FRESNO
AUG 15 2018
DEPARTMENT OF PUBLIC WORKS
AND PLANNING
DEVELOPMENT SERVICES DIVISION

COLE AVE

KEY PAD DETAIL

SIDE VIEW

END VIEW

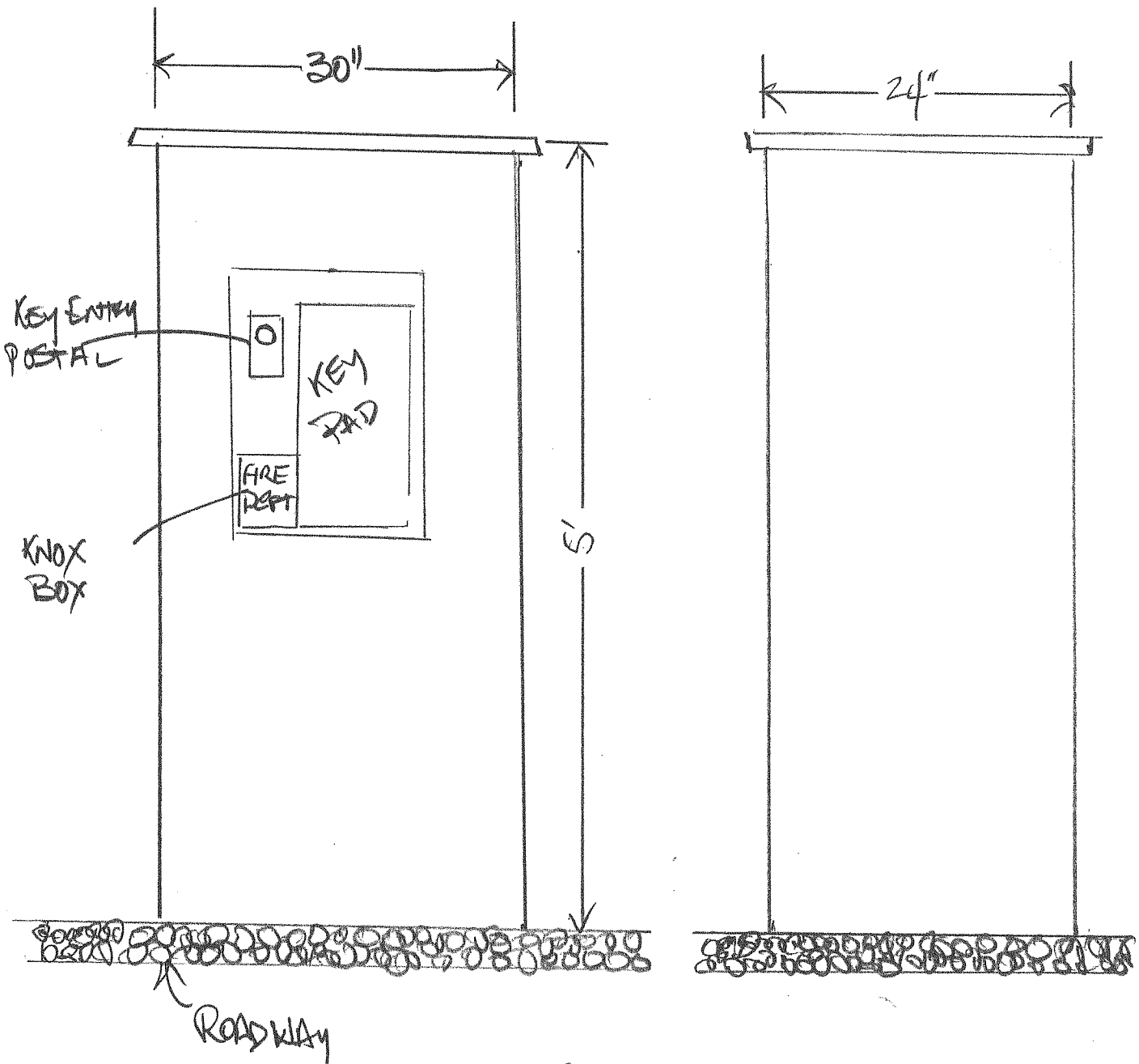

SCALE 1" = 1'

VARIANCES IN A 15 MILE RADIUS

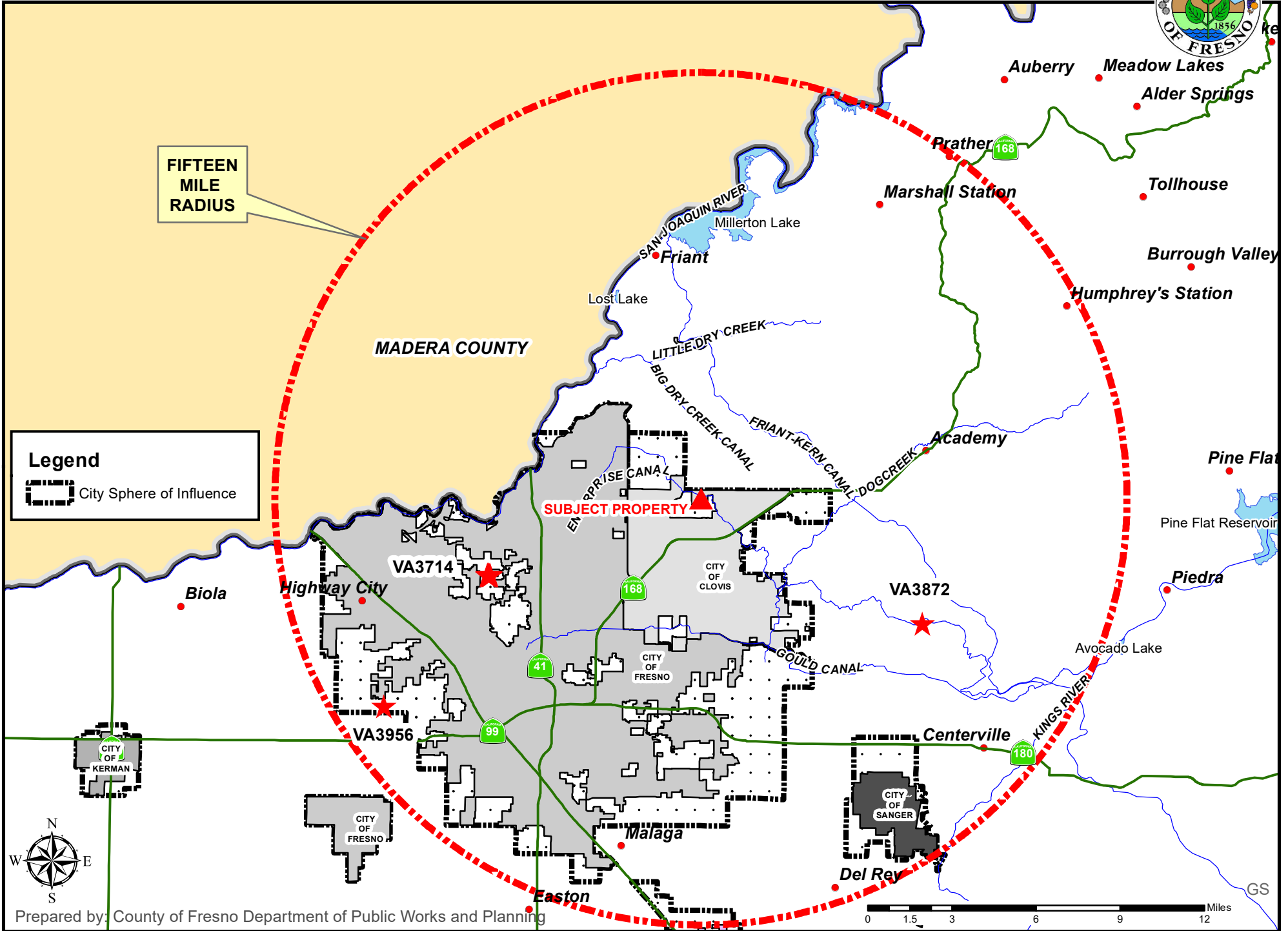

Legend
 City Sphere of Influence

FIFTEEN MILE RADIUS

SUBJECT PROPERTY

VA3714

VA3956

VA3872

EXHIBIT 6

July 19, 2018

Department of Public Works and Planning
2220 Tulare Street, 6th Floor
Fresno, California 93721

Re: Tract No. 3057 Variance Request

Dear Sirs:

You will find enclosed:

1. Our variance application and fees
2. Our pre-application review form
3. Copies of the Deeds and legal descriptions
4. Photographs of the sites
5. 4 copies of the parcel maps and site plans
6. Proposed gate entrance specifications
7. This letter, which includes a statement of variance findings

BACKGROUND FOR THE APPLICATION

Tract No. 3057 consists of seven single family residence parcels all ranging in size from 2.03 acres to 2.23 acres. Our community has had a significant increase of traffic going down Fowler Avenue and with the development of properties to the north of us and being annexed to the city it has placed an increased traffic burden on our community. The poor traffic design to the north of us has made it necessary for residents between the Enterprise Canal and Shepherd Avenue to use Cole Avenue as a U-turn option. Within our community there are twelve children under the age of 13 and we have found that the speeds on our dead-end road present a clear and present danger to the children who are playing in their front yard. In late 2016 we had a meeting of all the residents and discussed the option of having the county vacate the road and then installing a gated entrance to separate our community from the increasing traffic and speeds of traffic coming down our cul-de-sac road. At that time, we unanimously agreed that this would be a good idea. At the time there was no urgency as there was no planned development that would take us into the city through annexation, so we felt we had a great deal of time. Since then, we have worked on an annexation agreement with the city and the county so that our agricultural rights can be preserved if and when we are annexed. With the approval of the master plan for the Dry Creek Preserve and the annexation agreement it is our belief now that the potential annex of our parcels through the city will occur within the next year or two. Therefore, it is imperative for us to complete our vacation and variance applications and install our gate for the community before annexed to the city.

Therefore, we are respectfully submitting this application with all the attachments necessary to process our vacation and variance.

STATEMENT OF VARIANCE FINDINGS

1. There are exceptional and extraordinary circumstances or conditions applicable to the property involved, which do not apply generally to other property in the vicinity having the identical zoning and classification. Development by the City of Clovis to the north of us and poor traffic patterns have resulted in Cole Avenue becoming a turn around so that residents that reside to the north of the Enterprise Canal can go north on Fowler. This has resulted in numerous U-turns and accidents at the intersection of Cole and Fowler as well as cars speeding down Cole Avenue seeking an outlet even

though it is posted "Not a Through Street". We have a number of young children that reside on our street and this has created a safety and traffic hazard.

Our situation is exceptional and extraordinary in that the City of Clovis virtually surrounds our rural residential neighborhood. In addition, there is additional development which has been approved per the Dry Creek Master Plan. It will make conditions and situations in our neighborhood even worse.

2. Such a variance is necessary for the preservation and enjoyment of a substantial property right of the applicant, which right is possessed by other property owners under like conditions of the vicinity having the identical zoning classification. Zoning of all of our parcels are rural residential and our roadway is a rural county road. This vacation and variance application is imperative for us to enjoy the rural residential lifestyle as the city continues to close in on us. With more development to the north of us and with the city closing we are concerned about drug activity and other illegal activities that are invited into our dark shielded properties by the vegetation. Our roadway is a rural county road and therefore, it is unlit, and a lot of vegetation exists on the sides of the road. We are increasingly concerned about our safety and illegal activities that are on the rise in our neighborhood. Therefore, this application is imperative so that we can continue to enjoy our rural residential lifestyle.
3. Granting of a variance will not be materially detrimental to the public welfare or injurious to property and improvement in the vicinity in which the property is located. Our proposal is to have a private gated entrance so that access will only granted to the seven properties on our road. This will not be detrimental to other properties or the community in so much as our roadway is a cul-de-sac and there is not an outlet. We will not be impeding traffic and the gate will be constructed in such a way as to not have an impact on any traffic flow on Fowler Avenue. Additionally, as you will see with our gate proposal and design we have included an enhanced ability for vehicles to accomplish U-turns legally. Essentially, our proposal will solve the problems that have been created by the city traffic patterns, which have not previously been provided. So, in essence the granting of our variance will materially take care of a problem that has been created and not addressed by the city or the county.
4. The granting of such a variance will not be contrary to the objectives of the general plan. In addition, I have been involved with the Dry Creek Preserve in developing the Dry Creek Preserve Plan. Also, I have been involved to great extent in the Annexation Agreement and all of the parcels in our neighborhood have executed the Annexation Agreement so that when we are brought into the city we will be able to maintain our rural residential lifestyle. The granting of this variance would simply ensure that we could continue even when annexation to the city is imposed on us, our rural residential lifestyle.

CONCLUSION

All of the residents recently met and affirmed their desire to move forward with this application. You will find that we have provided a signature line for all of the 7 parcels and that everyone is in unanimous consent of our desire to vacate the road, apply for the variance, and to construct a private gated entrance. We have discussed all of the costs that will be incurred as well as establishing a bank account for us to provide a reserve for future gate and road maintenance. Our small neighborhood is a special place and will become even more unique as the City of Clovis grows in around us. Therefore, to maintain our rural lifestyle and the character of our neighborhood it is imperative that the county grant us the opportunity to protect our safety and security through the vacation, variance, and installation of a private gated entrance.