



County of Fresno

DEPARTMENT OF PUBLIC WORKS AND PLANNING
STEVEN E. WHITE, DIRECTOR

ADDENDUM

Planning Commission Staff Report Agenda Item No. 6 December 14, 2017

SUBJECT: Variance Application No. 4035

Allow an 11-foot front-yard setback where a 35-foot minimum is required, for the proposed construction of a 1,080 square-foot detached garage on a 3.89-acre parcel in the AE-5 (Exclusive Agricultural, 5-acre minimum parcel size) Zone District.

LOCATION: The project site is located on the north side of Little Shuteye Lane, at its intersection with Woodland Road, within the unincorporated community of Shaver Lake (39764 Little Shuteye Lane) (SUP. DIST. 5) (APN 130-410-08).

OWNER: Larry McKoane
APPLICANT: David Baisa, AIA

STAFF CONTACT: Jeremy Shaw, Planner
(559) 600-4207

Marianne Mollring, Principal Planner
(559) 600-4569

RECOMMENDATION:

- Approve Variance Application No. 4035 with recommended Findings and Conditions; and
- Direct the Secretary to prepare a Resolution documenting the Commission's action.

EXHIBITS:

1. Revised Conditions of Approval and Project Notes
2. Revised Site Plan
3. Staff Report and Exhibits Dated October 26, 2017

ENVIRONMENTAL ANALYSIS:

It has been determined pursuant to Section 15305 of the California Environmental Quality Act (CEQA) guidelines that the proposed project will not have a significant effect on the environment and is not subject to CEQA.

PUBLIC NOTICE:

Notices for the October 26, 2017 hearing were sent to 43 property owners within 1,320 feet of the subject parcel, exceeding the minimum notification requirements prescribed by the California Government Code and County Zoning Ordinance.

PROCEDURAL CONSIDERATIONS:

A Variance (VA) may be approved only if four Findings specified in the Fresno County Zoning Ordinance, Section 877 are made by the Planning Commission.

The decision of the Planning Commission on a Variance Application is final, unless appealed to the Board of Supervisors within 15 days of the Commission's action.

BACKGROUND INFORMATION:

This item was originally heard by the Planning Commission at the regularly-scheduled meeting of October 26, 2017. During Staff's prepared presentation, it was made known that the proposed detached garage would encroach into an existing ten-foot-wide Public Utility Easement (PUE), identified on the original tract map by Development Engineering staff, Development Services Division. The item was tabled by the Commission, while staff verified the location of the Public Utility Easement and confirmed that the proposed structure would be encroaching into the PUE as shown on the site plan. Subsequently, the Commission approved a motion to continue the item to the regularly-scheduled meeting of December 14, 2017 to consider revised project plans.

The revised Conditions of Approval and Project Notes, a revised site plan showing the proposed garage location outside of the ten-foot-wide Public Utilities Easement (PUE), and the Staff Report and Exhibits dated October 26, 2017, have been included as Exhibits with this Addendum.

This Variance request proposes to allow a waiver of the front-yard setback, where a 35-foot minimum is required, to construct a 1,080 square-foot detached garage approximately 24 feet into the front-yard (street side) setback approximately 40 feet from the existing residence, and 11 feet from the southern property line. The proposed detached garage will entail an approximate 1,080 square-foot encroachment into the front-yard setback.

CONCLUSION:

Based on the factors cited in the Analysis of the staff report dated October 26, 2017, Staff believes the required Findings for granting the Variance can be made. Staff therefore recommends approval of Variance Application No. 4035, subject to the recommended Conditions of Approval and Project Notes.

PLANNING COMMISSION MOTIONS:

See the Staff Report Dated October 26, 2017, attached as Exhibit 3 for recommended motions.

JS:ksn

G:\4360Devs&PIn\PROJSEC\PROJDOCS\VA\4000-4099\4035\SR\VA4035 SR ADDENDUM.docx

**Variance Application No. 4035
Conditions of Approval and Project Notes**

Conditions of Approval	
1.	Development shall be in substantial compliance with the site plan, floor plan and elevations, as approved by the Planning Commission.
2.	The proposed detached garage structure shall not encroach into the existing ten-foot-wide Public Utility Easement (PUE) as shown on the approved site plan. Additionally, it shall be the Applicant's responsibility to ensure that the location of the Public Utilities Easement be verified by a licensed surveyor, using an appropriate surveyors marker or monument prior to inspection and subject to approval by the Fresno County Department of Public Works and Planning.

Conditions of Approval reference recommended Conditions for the project.

Notes	
The following Notes reference mandatory requirements of Fresno County or other Agencies and are provided as information to the project Applicant.	
1.	Plans related to construction of the project shall be submitted to the Development Services and Capital Projects Division of the Fresno County Department of Public Works and Planning for review and approval in order to acquire building and installation permits, and necessary inspections.
2.	Any additional runoff generated by the proposed development cannot be drained across property lines and must be retained on site or disposed of per County Standards.
3.	A Grading Permit or Voucher shall be required for any grading activity associated with this proposal.
4.	Plans, permits and inspections will be required for all existing and proposed improvements on the subject property.
5.	This proposed development shall comply with California Code of Regulations Title 24-Fire Code; additionally, this project/development will be subject to the requirements of the current Fire Code and Building Code when a building permit or certificate of occupancy is sought.

JS:ksn

G:\4360Devs&Pln\PROJSEC\PROJDOCS\VA\4000-4099\4035\SR\VA4035 Conditions & PN REV (Ex 1).docx

EXHIBIT 1

NEW DETACHED PRIVATE GARAGE (ACCESSORY STRUCTURE) FOR:

LARRY McKOANE

39764 LITTLE SHUTEYE RD.
 SHAVER LAKE, CA 93664 PH.
 559-435-5000 EXT. 202
 A.P.N. # 13041008

SITE DATA:

LEGAL DESC.:
 LOT 24 OF SHAVER FALLS TRACT MAP NO. 2294 RECORDED IN
 VOLUME 27 OF PLATS AT PAGES 9 THROUGH 14, F.C.R.,
 SITUATED IN THE SOUTHEAST QUARTER OF SECTION 3, TOWNSHIP
 10 SOUTH, RANGE 24 EAST, M.D.B.& M.

ADDRESS: 39764 LITTLE SHUTEYE RD.
 SHAVER LAKE, CA 93664

APN: 13041008

ZONING: AE5

LOT AREA: 3.89 AC

EXISTING S.F.R. AREA: 1,840 S.F.

PROPOSED DETACHED GARAGE AREA: 1,080 S.F.
 (OCC. CLASS "U", CONST. TYPE "V-B")

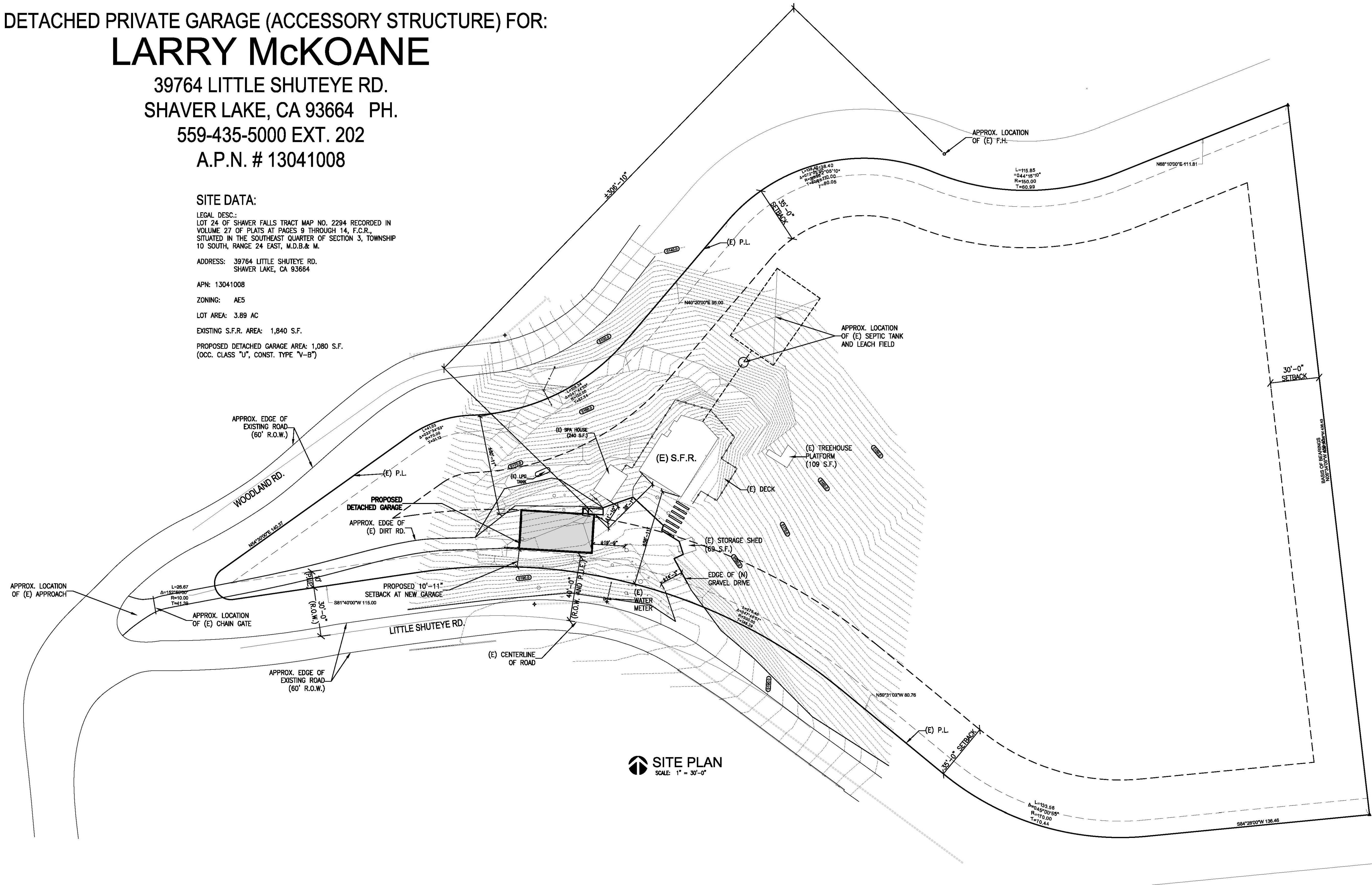

SITE PLAN
 SCALE: 1" = 30'-0"

EXHIBIT 2

McKOANE RESIDENCE DETACHED GARAGE
 39764 LITTLE SHUTEYE LANE SHAVER LAKE, CA
DETACHED GARAGE

David Baisa, AIA
 4045 N. Fremont St., Suite #103, Fresno, CA 93726
 PH. 559-229-8728 david@baisaandgroup.com

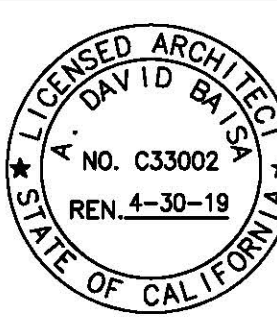
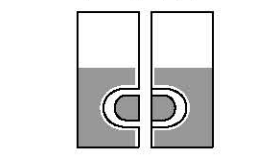

DRAWING CONTENTS:
SITE PLAN

DATE	5-17-17
REV	
REV	
JOB	1705-DB-SLG
SHEET	

A-0.1

McKANE RES. DRWG - SHAVER LAKE



County of Fresno

DEPARTMENT OF PUBLIC WORKS AND PLANNING
STEVEN E. WHITE, DIRECTOR

Planning Commission Staff Report Agenda Item No. 3 October 26, 2017

SUBJECT: Variance Application No. 4035

Allow a waiver of the front-yard setback where a 35-foot minimum is required, for the proposed construction of a 1,080 square foot detached garage on a 3.89-acre parcel in the AE-5 (Exclusive Agricultural, 5-acre minimum parcel size) Zone District.

LOCATION: The project site is located on the north side of Little Shuteye Lane, at its intersection with Woodland Road, within the unincorporated community of Shaver Lake (39764 Little Shuteye Lane) (SUP. DIST. 5) (APN 130-410-08).

OWNER: Larry McKoane
APPLICANT: David Baisa, AIA

STAFF CONTACT: Jeremy Shaw, Planner
(559) 600-4207

Marianne Mollring, Principal Planner
(559) 600-4227

RECOMMENDATION:

- Approve Variance Application No. 4035 with recommended Findings and Conditions; and
- Direct the Secretary to prepare a Resolution documenting the Commission's action.

EXHIBITS:

1. Conditions of Approval and Project Notes
2. Location Map
3. Existing Zoning Map
4. Existing Land Use Map
5. Variance Map
6. Site Plans
7. Floor Plans and Elevations
8. Applicant’s Submitted Findings

SITE DEVELOPMENT AND OPERATIONAL INFORMATION:

Criteria	Existing	Proposed
General Plan Designation	Mountain Residential	No change
Zoning	AE-5 (Exclusive Agricultural, 5-acre minimum parcel size) Zone District	No change
Parcel Size	3.89 acres	No change
Project Site	3.89-acre parcel improved with a 1,910 square-foot single-family residence and three additional detached structures as listed below	No change, other than the addition of a detached garage as described below
Structural Improvements	Existing 1,910 square-foot single-family residence with a 240 square-foot detached spa house and 69 square-foot storage shed and a 109 square-foot tree house platform	The addition of a 1,080 square-foot detached garage completely encroaching into the required front-yard setback (35-foot minimum required) five feet from the southern property line
Nearest Residence	Approximately 270 feet north	No change
Surrounding Development	North: Residential	No change
	East: Residential	No change
	South: Residential	No Change
	West: Residential	No Change

EXISTING VIOLATION (Y/N) AND NATURE OF VIOLATION: N

ENVIRONMENTAL ANALYSIS:

It has been determined pursuant to Section 15305 of the California Environmental Quality Act (CEQA) guidelines that the proposed project will not have a significant effect on the environment and is not subject to CEQA.

PUBLIC NOTICE:

Notices were sent to 43 property owners within 1,320 feet of the subject parcel, exceeding the minimum notification requirements prescribed by the California Government Code and County Zoning Ordinance.

PROCEDURAL CONSIDERATIONS:

A Variance (VA) may be approved only if four Findings specified in the Fresno County Zoning Ordinance, Section 877 are made by the Planning Commission.

The decision of the Planning Commission on a Variance Application is final, unless appealed to the Board of Supervisors within 15 days of the Commission’s action.

BACKGROUND INFORMATION:

This Variance request proposes to allow a waiver of the front-yard setback, where a 35-foot minimum is required, to construct a 1,080 square-foot detached garage completely within the front-yard (street side) setback approximately 40 feet from the existing residence and five feet from the southern property line. The proposed detached garage will entail a 1,080 square-foot encroachment into the front-yard setback.

The subject parcel was originally created as Lot No. 24, Sheet 6 of the Shaver Falls Subdivision recorded as Tract No. 2294 on July 5, 1972. According to County records, permits were issued for the existing 1,910 square-foot single-family residence in October of 1981.

In addition to the subject application, there have been nine other variance applications approved by the Planning Commission relating to front-yard setbacks within one mile of the subject property. Of those nine, five pertained to setbacks for attached or detached garages.

Although there have been previous variance requests in the area of the subject property, each variance request is considered on its own merit, based on site conditions and circumstances.

Application/Request	Date of Action	Staff Recommendation	Final Action
VA No. 2950: Allow a reduced front-yard setback for the construction of a single-family residence and garage in the AE-5 Zone District	9/26/1985	Approval	Approved by Planning Commission

VA No. 3167: Allow a ten-foot front-yard setback in the E-5 Zone District	10/20/1988	Approval	Approved by Planning Commission
VA No. 3253: Allow a zero-foot front-yard setback for a proposed garage and a two-foot front-yard setback for a covered patio in the AE-5 Zone District	4/12/1990	Approval	Approved by Planning Commission
VA No. 3312: Allow a zero-foot front-yard setback for a single-family residence in the AE-5 Zone District	2/21/1991	Approval	Approved by Planning Commission
VA No. 3376: Allow a zero-foot front-yard setback for a detached garage and a five-foot front-yard setback for a proposed residence in the AE-5 Zone District	7/9/1992	Approval	Approved by Planning Commission
VA No. 3408: Allow a 28-foot front-yard setback in the R-1-C(m) Zone District	3/25/1993	Approval	Approved by Planning Commission
VA No. 3496: Allow a six-foot side-yard setback to accommodate an addition to a single-family residence in the R-1-C(m) Zone District	8/10/1995	Denial	Approved by Planning Commission
VA No. 3559: Allow nine-foot, three-inch and ten-foot, three-inch side-yard setbacks for an attached garage addition in the R-1-B(c) Zone District	1/23/1997	Approval	Approved by Planning Commission
VA No.3817: Allow a 11-foot front-yard setback (35 feet required) for a detached garage in the AE-5 Zone District	6/9/2005	Denial	Approved by Planning Commission

DISCUSSION:

Findings 1 and 2: *There are exceptional or extraordinary circumstances or conditions applicable to the property involved which do not apply generally to other property in the vicinity having the identical zoning classification; and*

Such variance is necessary for the preservation of a substantial property right of the applicant, which right is possessed by other property owners under like conditions in the vicinity having the identical zoning classification.

	Current Standard:	Proposed Operation:	Is Standard Met (y/n)
Setbacks	Front (west) 35 feet	Front (south) 0 feet	No
	Rear (east) 20 feet	No change	Yes
	Street Side (north and south) 35 feet	No change	Yes
Parking	One parking space for each residence	No change	Yes
Lot Coverage	No requirements	The addition of a 1,080 square-foot detached garage	N/A
Space Between Buildings	Six feet minimum between main and accessory buildings	No change	Yes
Wall Requirements	No requirement	No requirement	N/A
Septic Replacement Area	100 percent	No change	Yes
Water Well Separation	Septic tank: 50 feet; Disposal field: 100 feet; Seepage pit: 150 feet	No change	Yes

Reviewing Agency/Department Comments:

Fresno County Department of Public Health, Environmental Health Division: No comments.

Development Engineering Section of the Fresno County Department of Public Works and Planning: Woodland Road is a 60-foot-wide private road and is maintained through County Service Area 35AS, Zone “Dogwood Mountain”. Little Shuteye Lane is a 60-foot-wide private road and is maintained through County Service Area 35AS, Zone “Dogwood Mountain”. In addition to the 60-foot private road easement there is a 10-foot public utility easement for a total half width of 40-feet from the centerline of the road easement. According to FEMA, FIRM Panel 0725H, the subject parcel is not located in a flood hazard area. Typically, any work done within the right-of-way to construct a new driveway or improve an existing driveway will require an Encroachment Permit from the Road Maintenance and Operations Division. A grading permit or voucher may be required for any grading proposed with this application.

Road Maintenance and Operations Division of the Fresno County Department of Public Works and Planning: Because the subject property is located in a mountainous area, extensive grading may be required depending on the location of the proposed structure, due to the uneven terrain. Access to the property is from Little Shuteye Lane, which is a private road maintained by County Service Area 35AS. In this case, no new driveway is proposed. If the Variance is approved, a grading permit or voucher must be obtained from the Road Maintenance and Operations Division.

Analysis:

In support of Findings 1 and 2, the Applicant states that the subject parcel is smaller than most others within the subdivision at 3.89 acres, and is asymmetrical in shape and has roads adjacent to two property lines, which effectively reduces the usable area within the required setbacks, particularly the area near the existing residence where the parcel tapers down to a narrow width on the west. The selected site for the proposed garage is the only relatively flat area near the residence and as such will require minimal grading.

Staff analysis of parcel and land use maps, as well as site photos, confirms that the subject parcel at 3.89-acres is smaller than most others in the vicinity, and is a legal non-conforming lot. Additionally, there are a number of other properties that, due to the configuration of the adjacent roads, are irregularly shaped, however the subject parcel is one of only a small number of parcels that have road frontage on more than one side and whose boundaries are defined by the contours of the roadway. Staff recognizes that a 35-foot-wide setback running along the subject parcel frontage on the south, west and north between Little Shuteye Lane and Woodland Road does reduce the buildable area of the subject parcel.

In support of Finding 2, the Applicant states that the subject property is three sided with street frontage on two sides, and as such, there is a required 35-foot setback for both street sides. Additionally, according to the Applicant's findings, the existing setbacks on all sides account for approximately 36 percent of the total parcel area, or approximately 1.4 acres. The proposed garage was sited to be as practically close to the existing residence as possible and to take advantage of the relatively flat topography of the site; accordingly, the construction of the garage is a property right that is enjoyed by other property owners in the area.

With regard to Finding 2, the approval of a variance request is intended to correct the deficit of a substantial property right of the owner, which is realized by other property owners within the same zone district, and under similar circumstances. The Applicant proposes to build a detached garage adjacent to the existing residence utilizing the only relatively flat, level area on the parcel. The property right at issue is the lack of a secure place to store vehicles that is also a convenient distance from the existing residence, which in this case is approximately 40 feet. Although covered parking is not required in agriculturally-zoned districts, staff recognizes that the ability to have enclosed vehicle storage during inclement weather could be considered a substantial property right that is not currently realized by the Applicant, and that the addition of the garage would correct this property right deficit.

A consideration in addressing the Variance Findings is whether there are alternatives available that would avoid the need for the Variance. One alternative would be to construct the garage outside of the required setbacks such that it will not encroach into any required yards; however, given the sloped topography of the subject parcel and the limited buildable area, and the fact that the subject parcel and surrounding area are densely forested, locating the garage in a different area could substantially increase both the need for additional grading and tree removal, and potentially increase surface water runoff at the site. The proposed garage will create a

1,080 square-foot encroachment into the front-yard setback. No reviewing departments or agencies expressed any concerns relating to surface runoff at the proposed site. Additionally, the subject parcel is not located in a flood hazard area.

Based on the above analysis, staff believes that there are exceptional circumstances and conditions applicable to the subject property that do apply to some other properties in the vicinity, however, variances have been approved for other properties to correct such circumstances and conditions. Staff also agrees that a substantial property right is at issue, which is the lack of enclosed covered parking on the subject property, a substantial benefit during adverse weather conditions, which would require a variance to be preserved. As noted in the table on pages three and four of this Staff Report, other properties in the vicinity of the subject property have been granted variances specifically for the addition of a garage, whether attached or detached. Staff agrees with the Applicant’s findings relating to the exceptional circumstances on the subject property and the substantial property right at issue here.

In this case, staff is able to make Findings 1 and 2.

Recommended Conditions of Approval:

See attached Exhibit 1.

Conclusion:

Findings 1 and 2 can be made.

Reviewing Agency/Department Comments:

No other comments specific to the adequacy of streets and highways were expressed by reviewing Agencies or Departments.

Finding 3: The granting of the Variance will not be materially detrimental to the public welfare or injurious to property and improvement in the vicinity in which the property is located.

Surrounding Parcels				
	Size:	Use:	Zoning:	Nearest Residence:
North	5.55 acres	Single-family residence	AE-5	Approximately 270 feet
South	4.55 acres	Single-family residence	AE-5	Approximately 260 feet
East	4.60 acres	Single-family residence	AE-5	Approximately 420 feet
West	4.13 acres	Single-family residence	AE-5	Approximately 350 feet

Reviewing Agency/Department Comments:

Fresno County Fire Protection District: The project will be subject to the requirements of the current Fire Code and Building Code when a building permit or certificate of occupancy is sought.

No other comments specific to land use compatibility were expressed by reviewing Agencies or Departments.

Analysis:

In support of Finding 3, the Applicant's submitted Findings state that the requested Variance will not have an adverse effect on surrounding properties, as the proposed use is consistent with the site conditions and character of this property and neighborhood. Additionally, the proposed finished floor elevation of the proposed garage will be approximately 11 feet below the crown of the adjacent roadway. According to the Applicant, the proposed garage will incorporate design features that match the existing residence, and will not be out of place in this environment.

In analyzing this proposal, staff considered the intent of restrictions to yard setbacks. A primary purpose of the setback standard is to protect the aesthetic character of an area by providing an offset of structures from the adjacent properties. In this case, the proposed garage would completely encroach into the front-yard setback and be located approximately five feet from the property line; however, although the structure will be visible, it will be partly screened from neighboring properties and the adjacent roadway by existing trees and the varying topography.

Staff notes that the aesthetic character of the Shaver Lake community is such that there is considerable variation in housing style, design and orientation on the property, which is often affected by the irregular topography of the area, characterized by mountains, trees and rock outcroppings. In the case of this Variance request, the Applicant has elected to construct the proposed garage in an area of the subject parcel that is relatively flat and has been previously graded, thereby minimizing the physical impacts to the property. Staff, agrees with the Applicants findings that the proposed structure will be consistent with the site conditions and character of the surrounding neighborhood.

Based on the above information, staff believes the proposal will not have an adverse effect upon surrounding properties.

Recommended Conditions of Approval:

None.

Conclusion:

Finding 3 can be made.

Finding 4: That the proposed development is consistent with the General Plan.

Relevant Policy:	Consistency/Considerations:
Shaver Lake Community Plan Policy 609-03:5.00: (a) Aesthetic standards should be developed in order to maintain the mountain character and to minimize adverse impacts on the natural setting; (b) New residential and commercial development shall reflect the mountain character of the area; and (c) Outstanding scenic views and panoramas should be preserved wherever possible.	No reviewing agencies/departments expressed any concerns about this proposal with regard to aesthetics. Further, staff did not identify any potential adverse impacts where any aesthetic or existing scenic views would be obstructed by the proposed detached garage. Additionally, the proposed garage is situated such that it would not obstruct sight lines from adjacent properties or the roadway.

Relevant Policy:	Consistency/Considerations:
<p>Shaver Lake Forest Specific Plan Policy 4.01:</p> <ol style="list-style-type: none"> 2. Permanent Structures shall be located in a manner that protects view corridors. Structure height and location shall be considered at the time of a Tentative Tract, Rezoning, or Conditional Use Permit application. 3. Appropriate landscaping and visual buffers shall be utilized to minimize visual impacts upon adjacent residential areas and scenic roadways. 	<p>In this case, the proposed garage will be located approximately five feet from the existing property line and approximately 24 feet from the edge of the adjacent roadway. However, according to the Applicant's Findings, the finished floor elevation of the proposed structure would sit approximately 11 feet below the crown of the adjacent roadway, thus minimizing its visibility from the roadway.</p>

Reviewing Agency Comments:

Policy Planning Section of the Fresno County Department of Public Works and Planning: Policy Planning has determined that there are no Agricultural Land Conservation Committee (Williamson Act) or General Plan issues with this application and has no further comments.

No other comments specific to General Plan Policies were expressed by reviewing Agencies or Departments.

Analysis:

In support of Finding 4, the Applicant's submitted Findings state that the granting of this Variance will not be contrary to the objectives of the County's General Plan, and that this proposal exhibits a compact growth pattern in an existing community and will utilize existing infrastructure and resources to the maximum extent possible.

The subject parcel is designated Mountain Residential in the County Adopted Shaver Lake Community Plan. The Shaver Lake Community Plan Policy 609-03:5.00 addresses aesthetic standards and preservation of scenic views. Staff notes that much of the housing is similar in architectural style, keeping with the mountain character of the area; however, the housing styles do vary in color, exterior treatments and construction materials. Appendix G of the General Plan contains policies that specifically address property development standards in each zone district. The subject property is currently in compliance with the standards of the AE-5 Zone District, with the exception of the minimum lot depth (see analysis under Findings 1 and 2 on Page 6 of this Staff Report). Accordingly, approval of this Variance request will not be in conflict with the goals of the Shaver Lake Community Plan or the County General Plan.

Based on these factors, staff believes the proposal is consistent with the General Plan and is therefore able to make Finding 4.

Recommended Conditions of Approval:

None.

Conclusion:

Finding 4 can be made.

PUBLIC COMMENT:

None.

CONCLUSION:

Based on the factors cited in the analysis, staff believes the required Findings for granting the Variance can be made. Staff therefore recommends approval of Variance Application No. 4035, subject to the recommended Conditions of Approval and Project Notes.

PLANNING COMMISSION MOTIONS:

Recommended Motion (Approval Action)

- Move to determine the required Findings can be made and move to approve Variance Application No. 4035, subject to the Conditions of Approval and Project Notes listed in Exhibit 1; and
- Direct the Secretary to prepare a Resolution documenting the Commission's action.

Alternative Motion (Denial Action)

- Move to determine that the required Findings cannot be made (state basis for not making the Findings) and move to deny Variance Application No. 4035; and
- Direct the Secretary to prepare a Resolution documenting the Commission's action.

Recommended Conditions of Approval and Project Notes:

See attached Exhibit 1.

JS:ksn
G:\4360Devs&PIn\PROJSEC\PROJDOCS\VA\4000-4099\4035\SR\VA4035 SR.docx

**Variance Application No. 4035
Conditions of Approval and Project Notes**

Conditions of Approval	
1.	Development shall be in substantial compliance with the site plan, floor plan and elevations, as approved by the Planning Commission.

Conditions of Approval reference recommended Conditions for the project.

Notes	
The following Notes reference mandatory requirements of Fresno County or other Agencies and are provided as information to the project Applicant.	
1.	Plans related to construction of the project shall be submitted to the Development Services Division of the Fresno County Department of Public Works and Planning for review and approval in order to acquire building and installation permits, and necessary inspections.
2.	Any additional runoff generated by the proposed development cannot be drained across property lines and must be retained on site or disposed of per County Standards.
3.	A Grading Permit or Voucher shall be required for any grading activity associated with this proposal.
4.	Plans, permits and inspections will be required for all existing and proposed improvements on the subject property.
5.	This proposed development shall comply with California Code of Regulations Title 24-Fire Code; additionally, this project/development will be subject to the requirements of the current Fire Code and Building Code when a building permit or certificate of occupancy is sought.

EXHIBIT 1

LOCATION MAP

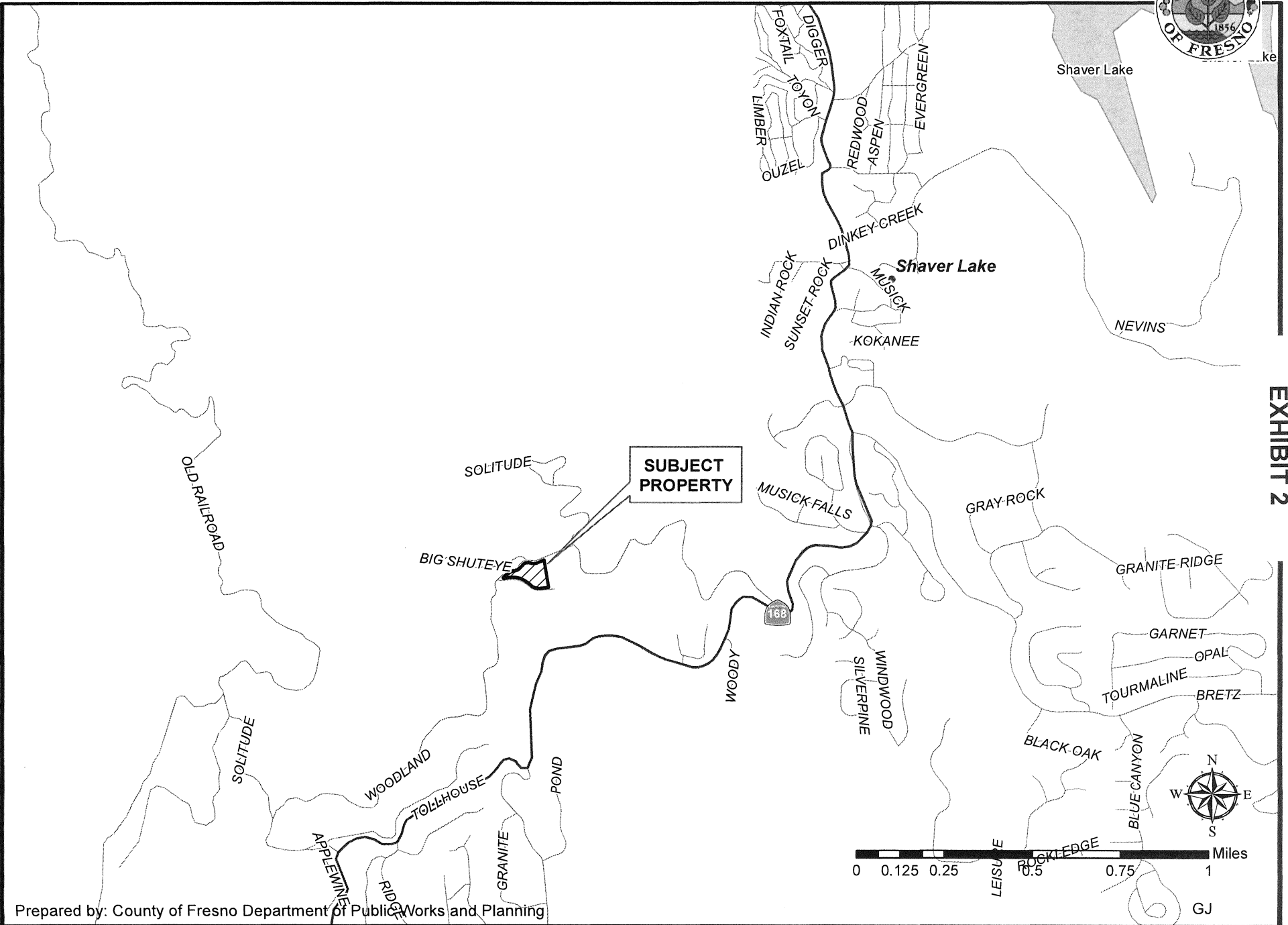
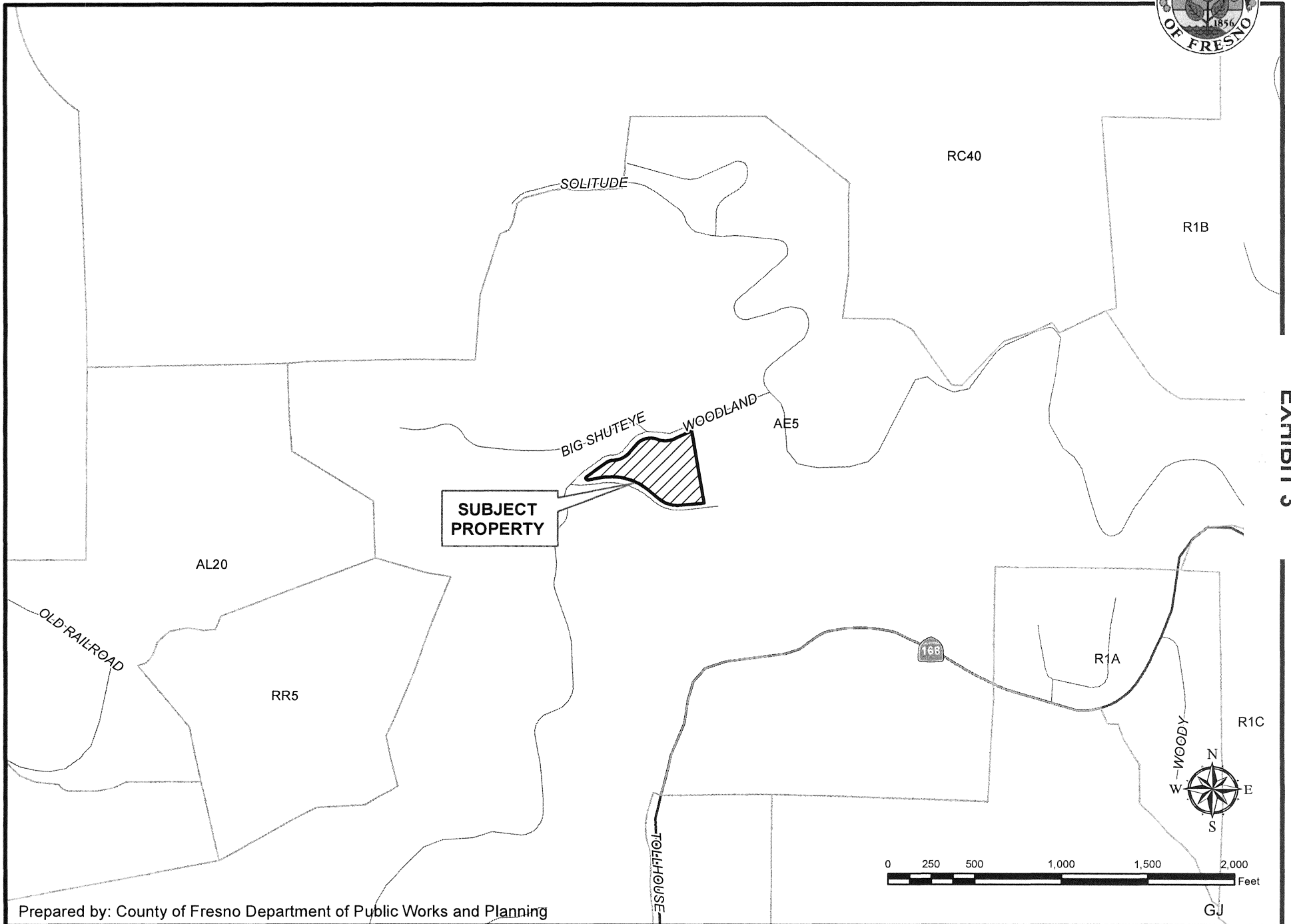

EXHIBIT 2

EXISTING ZONING MAP



VA 4035

EXISTING LAND USE MAP

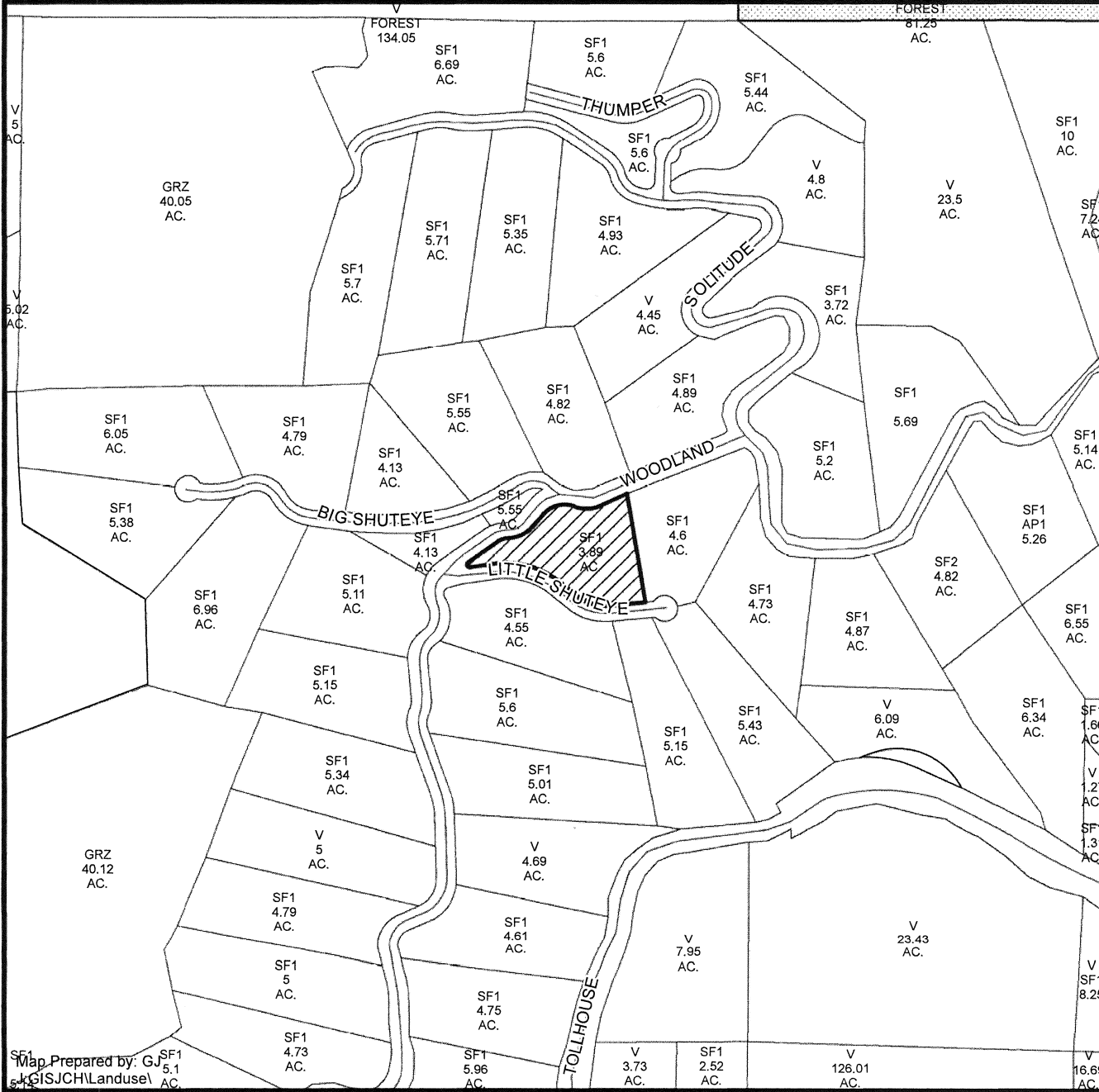

LEGEND	
GRZ - GRAZING	
SF# - SINGLE FAMILY RESIDENCE	
V - VACANT	
AP1 - APARTMENT	

LEGEND:

-  Subject Property
-  Ag Contract Land

EXHIBIT 4

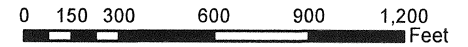
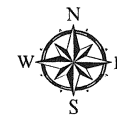

Department of Public Works and Planning
Development Services Division

Map Prepared by: GIS/JCH/landuse

NEW DETACHED PRIVATE GARAGE (ACCESSORY STRUCTURE) FOR:

LARRY McKOANE

39764 LITTLE SHUTEYE RD.
 SHAVER LAKE, CA 93664 PH.
 559-435-5000 EXT. 202
 A.P.N. # 13041008

SITE DATA:

LEGAL DESC:
 LOT 24 OF SHAVER FALLS TRACT MAP NO. 2294 RECORDED IN
 VOLUME 27 OF PLATS AT PAGES 8 THROUGH 14, F.C.R.,
 SITUATED IN THE SOUTHEAST QUARTER OF SECTION 3, TOWNSHIP
 10 SOUTH, RANGE 24 EAST, M.D.B.& M.
 ADDRESS: 39764 LITTLE SHUTEYE RD.
 SHAVER LAKE, CA 93664
 APN: 13041008
 ZONING: AES
 LOT AREA: 3.89 AC
 EXISTING S.F.R. AREA: 1,840 S.F.
 PROPOSED DETACHED GARAGE AREA: 1,080 S.F.
 (OCC. CLASS "U", CONST. TYPE "Y-B")

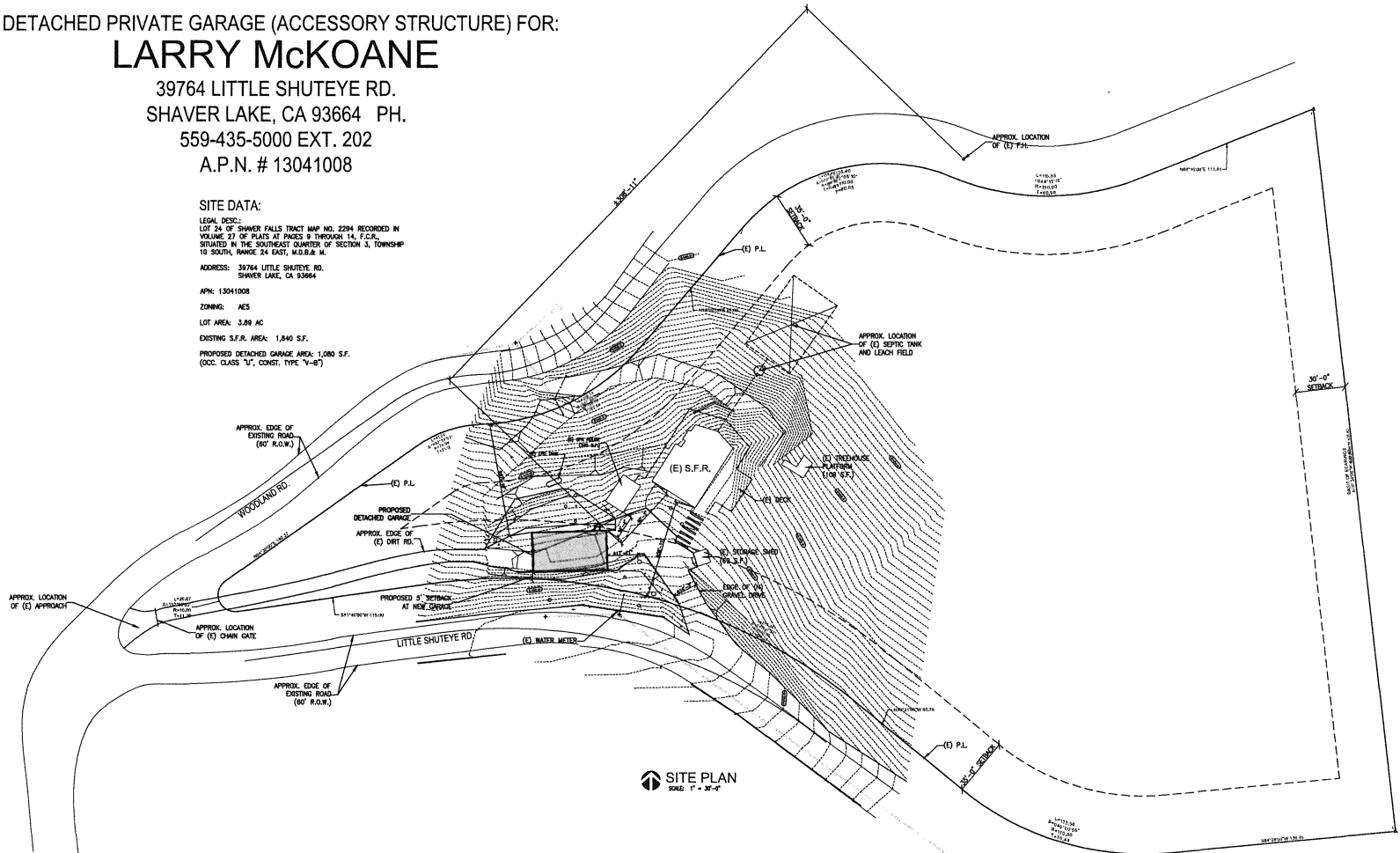

SITE PLAN
 SCALE: 1" = 30'-0"

MCKOANE RESIDENCE DETACHED GARAGE
 39764 LITTLE SHUTEYE LANE SHAVER LAKE, CA
DETACHED GARAGE

EXHIBIT 6

DRAWING CONTENTS:
 SITE PLAN

DATE: 9-17-17
REV
REV
JOB 1705-09-06
SHEET

A-0.1

1/2" = 1' SCALE - 2009 USE

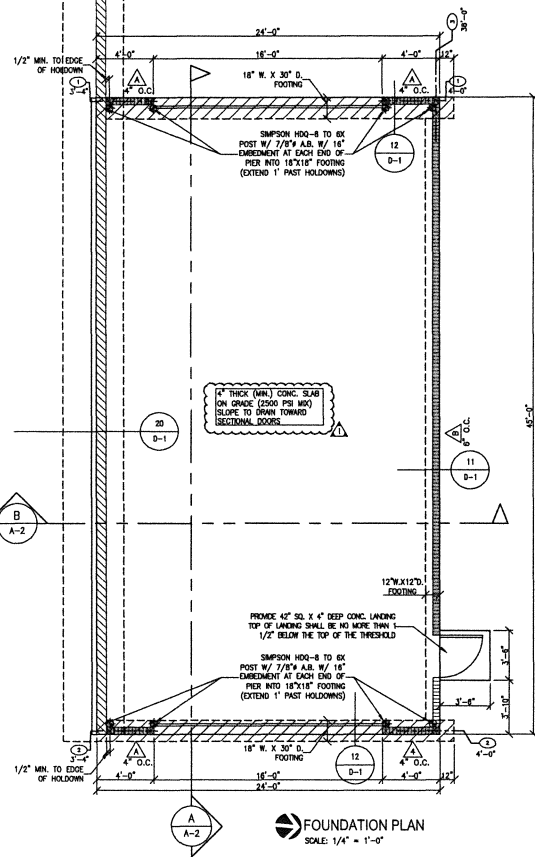

FOUNDATION PLAN
SCALE: 1/4" = 1'-0"

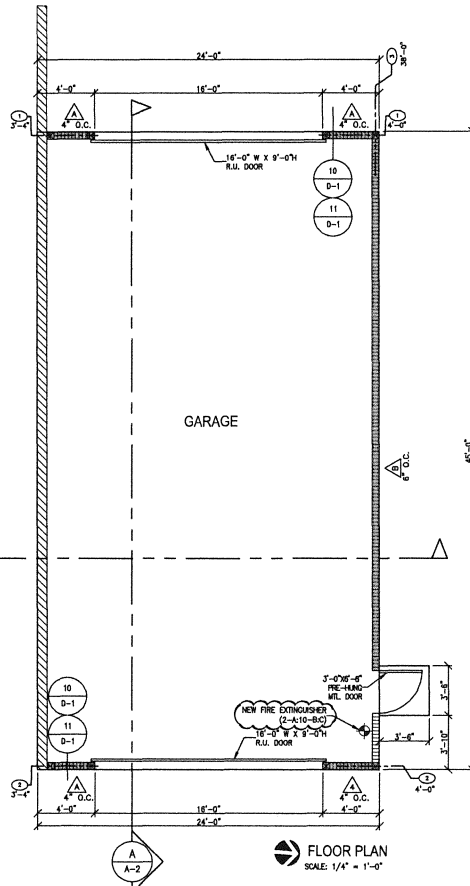

FLOOR PLAN
SCALE: 1/4" = 1'-0"

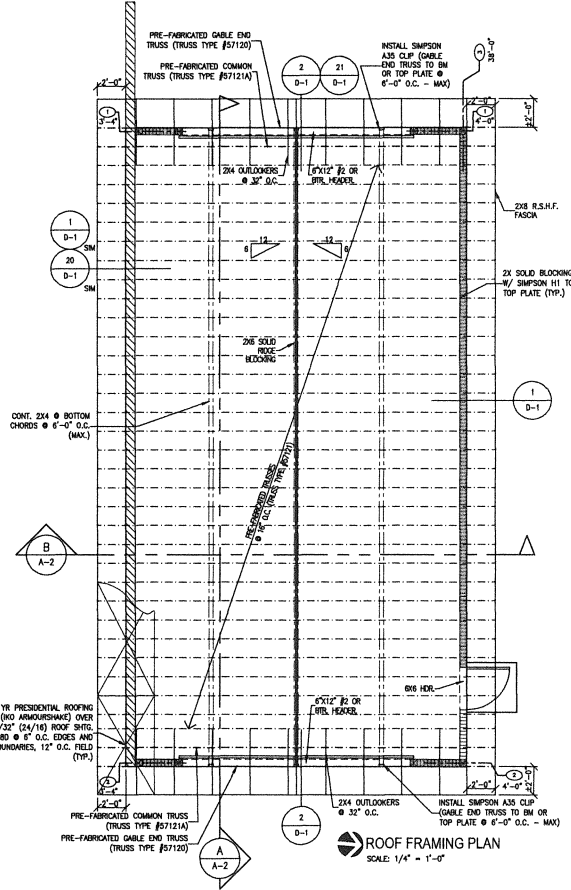

ROOF FRAMING PLAN
SCALE: 1/4" = 1'-0"

FOUNDATION NOTES:

- ALL CONCRETE SHALL BE 2500 P.S.I. DESIGN MIX (28 DAYS).
- ALL FOOTINGS TO EXTEND TO A MINIMUM OF 18" BELOW UNDISTURBED SOIL OR AS OTHERWISE NOTED.
- CONCRETE SLAB AND FOOTINGS SHALL BE FORMED MONOLITHICALLY.
- ROOF EXTERIOR WALL SILL PLATES WITH 1/2" X 14" ANCHOR BOLTS @ 4'-0" O.C. MAXIMUM AND 12" MAXIMUM FROM ALL CORNERS AND SPICES. PROVIDE A MINIMUM OF (2) A.B. PER SILL PLATE FOR SHORT WALL SECTIONS. SET BOLTS 17" MINIMUM INTO FOOTING AT ALL EXTERIOR WALLS. USE 1/2" X 3" X 3/16" THK. STEEL PLATE INSIDE OF ALL ANCHOR BOLTS. ANCHOR BOLTS SHALL BE INSTALLED IN THE MIDDLE 1/3 OF THE PLATE. ANCHOR BOLT EMBEDMENT DEPTH SHALL BE DETERMINED FROM THE TOP OF SLAB.
- LOCATE AND EXPOSE ALL PROPERTY CORNERS AND STRING THE SIDE YARD PROPERTY LINES PRIOR TO THE FOUNDATION INSPECTION.
- 14" LONG ANCHOR BOLTS SHALL BE USED WHERE GARAGE STEIN WALLS OCCUR.
- ALL HOLDINGS, SPECIAL ANCHOR BOLTING REQUIREMENTS AND STRAPS THAT ARE APPLICABLE TO THE BUILDING SHALL BE IN PLACE AT THE TIME OF FOUNDATION INSPECTION.
- SILL PLATES SHALL BE PRESURE-PRESERVATIVE TREATED WOOD OR NATURALLY DURABLE TERNITE RESISTANT WOOD.
- PROVIDE 1/2" MIN. TO EMBLEM SEPARATION.
- MAXIMUM ALLOWABLE SOIL BEARING CAPACITY IS 2,000 POUNDS PER SQUARE FOOT.

- FRAMING NOTES:**
- SHEETS USED IN THE CONSTRUCTION OF DIAPHRAGMS AND SHEAR WALLS SHALL NOT BE LESS THAN 4'x8" IN SIZE.
 - MINIMUM SIZE SHEET AT BOUNDARIES & CHANGES IN FRAMING SHALL BE 24" UNLESS BLOCKED.

SHEARWALL SCHEDULE
SHEAR WALLS MUST EXTEND TO ROOF OR FLOOR SHEATHING.

SYMBOL	PANEL SHEATHING	PANEL SILL PLATES	FIELD SILL PLATES	FIELD	ANCHOR BOLTS TO CONCRETE	SILL PLATE ATTACHMENT	HOLDINGS
△	3/8" MIN. COX OR OSB	2x8 @ 4' O.C.	2x8 @ 4' O.C.	2x8 @ 4' O.C.	2x 1/2" DIA. @ 48" O.C.	2x SILL PLATE TO EX POST	2x SIMPSON HDG. AT END OF POST
△	3/8" COX OR OSB	2x8 @ 4' O.C.	2x8 @ 4' O.C.	2x8 @ 4' O.C.	2x 1/2" DIA. @ 48" O.C.	2x NOT REQUIRED	2x NOT REQUIRED

NOTE: ALL WALL STUDS SHALL BE 14" O.C. UNLESS OTHERWISE NOTED.

LUMBER LEGEND:

LOCATION	SIZE	SPECIES / GRADE
STUDS	2x8	D.F. / #2 OR BETTER
TOP PLATES	2x8	D.F. / #2 OR BETTER
SILL PLATES	2x8	REDWOOD OR END GRADE
HEADERS	2x8	D.F. / #2 GRADE OR BETTER
HEADERS**	2x8	D.F. / #2 GRADE OR BETTER
OUTLEAKERS	2x8	D.F. / #2 OR BETTER
FASCIA	2x8	R.S.H.F.

* MAIN DOOR - EXTERIOR
** ROLL-UP DOOR

WALL LEGEND

- 2x8 STUDS @ 16" O.C. W/ 1/2" LOG SPACING OVER (2) LAYERS TYPE "D" W.P. PAPER OVER 5/8" PLUMBO OR OSB SHEET (EXTERIOR), (NO FINISH @ INTERIOR)
- 8"x8"x16" CMU WALL. SEE DETAIL #20/D-1
- INDICATES SHEAR WALL LINES. REFER TO SHEAR WALL SCHEDULE FOR ADDITIONAL REQUIREMENTS.
- SHEAR WALL TYPE
- SHEAR WALL FASTENER EDGE SPACING (6d)

FLOOR PLAN NOTES:

- ALL STUDS SHALL BE CONTINUOUS FULL HEIGHT WHERE UNSUPPORTED LATERALLY.
- CONTRACTOR TO VERIFY WITH OWNER FOR PIPE SLEEVES UNDER CONCRETE AND THROUGH FOOTINGS FOR IRRIGATION PIPING AND ELECTRICAL CONDUIT.
- FINGER JOINTED STUDS MUST BE GRADE STAMPED BY AN APPROVED ICC INSPECTION AGENCY.
- REQUIRED EGRESS DOOR SHALL NOT BE LESS THAN 78" MEASURED FROM THE TOP OF THRESHOLD TO THE BOTTOM OF THE DOOR STOP.
- PROVIDE FIRE BLOCKING HORIZONTALLY AT INTERVALS NOT EXCEEDING 10'.
- DOOR LANDINGS SHALL BE:
 - WIDTH OF DOOR WITH 3/4" MINIMUM IN THE DIRECTION OF TRAVEL. (IRC R311.3)
 - NO MORE THAN 1-1/2" LOWER THAN THE TOP OF THE THRESHOLD. (IRC R311.3.1)

TRUSS AND ROOF NOTES:

- DESIGN LOAD 116/S.F. D.L. & 20/S.F. L.L.
- APPROVED TRUSS DRAWINGS MUST BE KEPT ON JOB SITE FOR INSPECTION PURPOSES.
- PANT ALL ROOF VENTS, ROOF JACKS, EDGE FLASHING & MISC. FLASHING & COUNTER FLASHING ASSOCIATED WITH NEW ROOF.
- PROVIDE PRE-FORMED RIDGE SHINGLES TO MATCH NEW ROOFING.
- MAXIMUM OPENINGS IN HORIZ. DIAPHRAGM NOT TO EXCEED 24" WITHOUT BLOCKING.
- MINIMUM SIZE SHEET AT BOUNDARIES & CHANGES IN FRAMING SHALL BE 24" UNLESS BLOCKED.
- SHEETS USED IN THE CONSTRUCTION OF DIAPHRAGMS AND SHEAR WALLS SHALL NOT BE LESS THAN 4'x8" IN SIZE.
- 2x4 OUTLEAKERS SHALL BE INSTALLED ON EDGE.
- PROVIDE TRIPLE TOP PLATES AT ALL BEARING WALLS.
- INSTALL ICE AND WATER BARRIER UNDER ROOFING TO A POINT 24" MIN. INSIDE THE EXTERIOR WALL LINE. INSTALL PER MANUFACTURERS INSTRUCTIONS.

FINISH NOTES:

- C.W.B. WALLING INSPECTION IS REQUIRED FOR THIS PROJECT.
- UNLIMITED
- ALL INTERIOR WALLS AND CEILINGS TO REMAIN UNFINISHED (NO INTERIOR FINISHES)

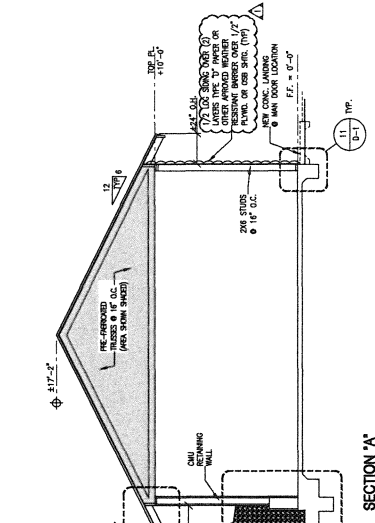

SECTION 'A'

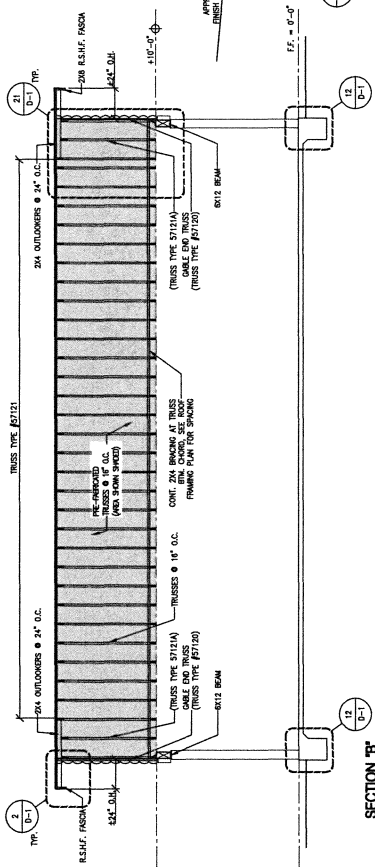

SECTION 'B'

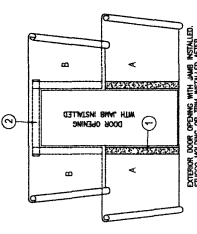

TYPICAL FLASHING DETAILS
N.T.S.

1. INSTALL FLASHING AS SHOWN. FLASHING IS NOT TO BE APPLIED TO THE SUBSTRATE UNTIL THE FLASHING IS INSTALLED OVER THE SUBSTRATE.
2. 1/2" WIDE ASPHALT-SATURATED ROOFING FELT PAPER OR APPROVED FLASHING MATERIAL, SECURED TO JAMB INDOOR, SHOULD BE INSTALLED OVER THE FLASHING MATERIAL.
3. ALL SUBSTRATE LINES ARE INSTALLED OVER FLASHING MATERIAL.

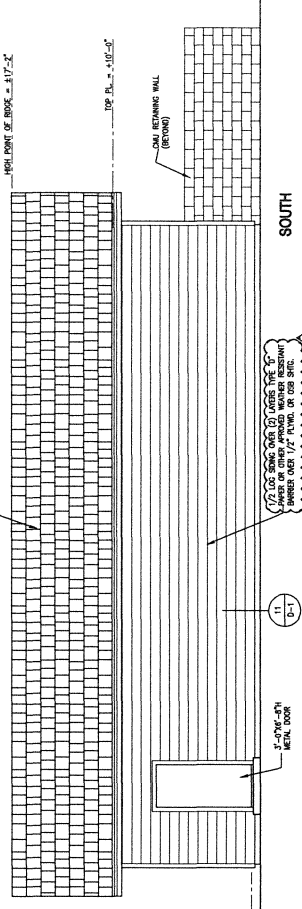

WEST

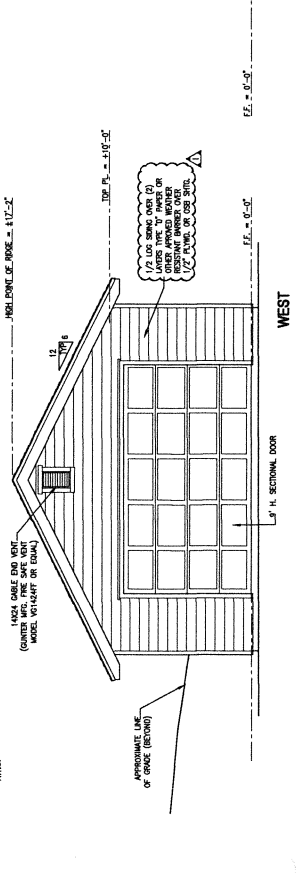

NORTH

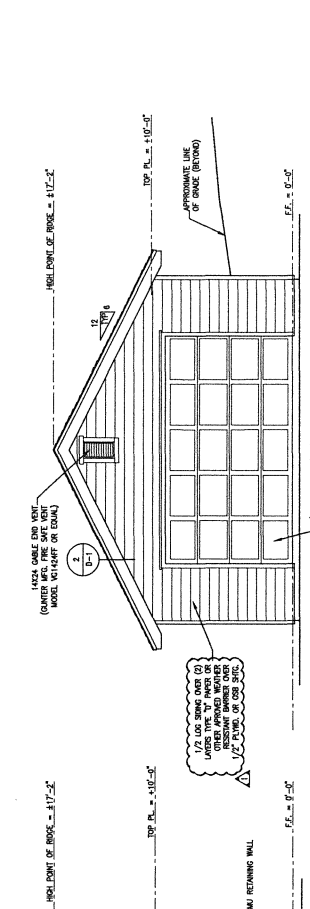

SOUTH

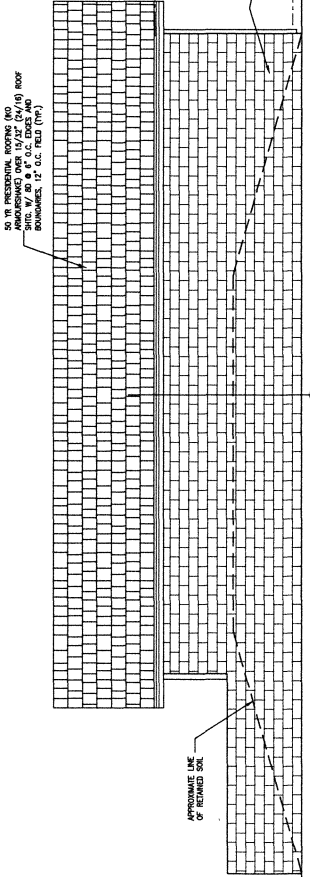

EAST

EXHIBIT 8

Findings of Fact pertaining to property located at
39764 Little Shuteye Ln. Shaver Lake, CA (Detached Private Garage in existing setback)

1. *There are exceptional or extraordinary circumstances or conditions applicable to the property involved which do not apply generally to other properties in the vicinity having the identical zoning classification.*

- The size of the parcel in question is a bit smaller than most neighboring properties. This fact combined with the irregular shape of the lot having adjacent roads along two property lines effectively reduces the useable area within the setbacks, particularly in the area near the existing residence. The shape of the existing property tapers to a narrow area near the location of the existing residence. The proposed location of the new detached garage has been selected as the only relatively flat area adjacent to the residence and takes advantage of the existing grading in order to minimize the environmental impacts of having to import fill and re-grade the site extensively.
- The existing residence sits a relatively close distance to the street (approximately 60 feet from the edge of Little Shuteye Ln.). The proposed detached garage would sit between the existing residence and the street in an area that has been previously roughly graded as a dirt and gravel road within the property. The allowance of the proposed location for this project will afford the applicant the use of their property in order to construct a secure private vehicle storage building in the proximity of the existing residence and on an existing area of the property which would not require extensive grading.

2. *Such a variance is necessary for the preservation and enjoyment of a substantial property right of the applicant, which right is possessed by other property owners under like conditions in the vicinity having the identical zoning classification.*

- The property is a three sided parcel with street sides on two of the three sides. As such, a 35' setback exists on both street sides. Approximately 36% of the parcel is currently dedicated as setback area. The proposed configuration was developed in order to place the proposed private vehicle garage within a reasonable distance of the existing residence, a property right that is enjoyed by other property owners in the area.

3. *The granting of the variance will not be materially detrimental to the public welfare or injurious to property and improvement in the vicinity in which the property is located.*

- The proposed use is consistent with the site conditions and character of this property and neighborhood. The proposed finish floor elevation will remain approximately 11 feet below the crown of the road adjacent to the property. The architectural features of the building will be designed to incorporate design features that exist on the main residence and will not be out of place in this environment.

4. *The granting of such variance will not be contrary to the objectives of the Fresno County General Plan.*

- The granting of this variance will not be contrary to the objectives of the county's General Plan. This project exhibits a compact growth pattern in an existing community and will utilize existing infrastructure and resources to the maximum extent possible.